



DENTAL INSTRUMENTS



CH 01-04

CH 01 English Pattern
Englische Form
Forma inglesa
Forma anglaise
Forma inglese

CH 02 With Alpha Handle
Mit Alfa-Griff
Con mango Alfa
Manche Alfa
Maniglia dell'alfa

CH 03 For children
Kinderzahnzangen
Para niños
Pour enfants
Per bambini

CH 04 American Pattern
Amerikanische form
Forma americana
Forme américaine
Forma americana

Dental Extraction Forceps

Forceps de extracción

Zahnzangen

Daviers

Pinze per estrazioni



All Extracting Dental Forceps are also available in **Non-Slip Grip Jaws**.
Please see page 11 for ordering details.



01-0101
Fig.1



01-0102
Fig.2



01-0103
Fig.3



01-0104
Fig.4

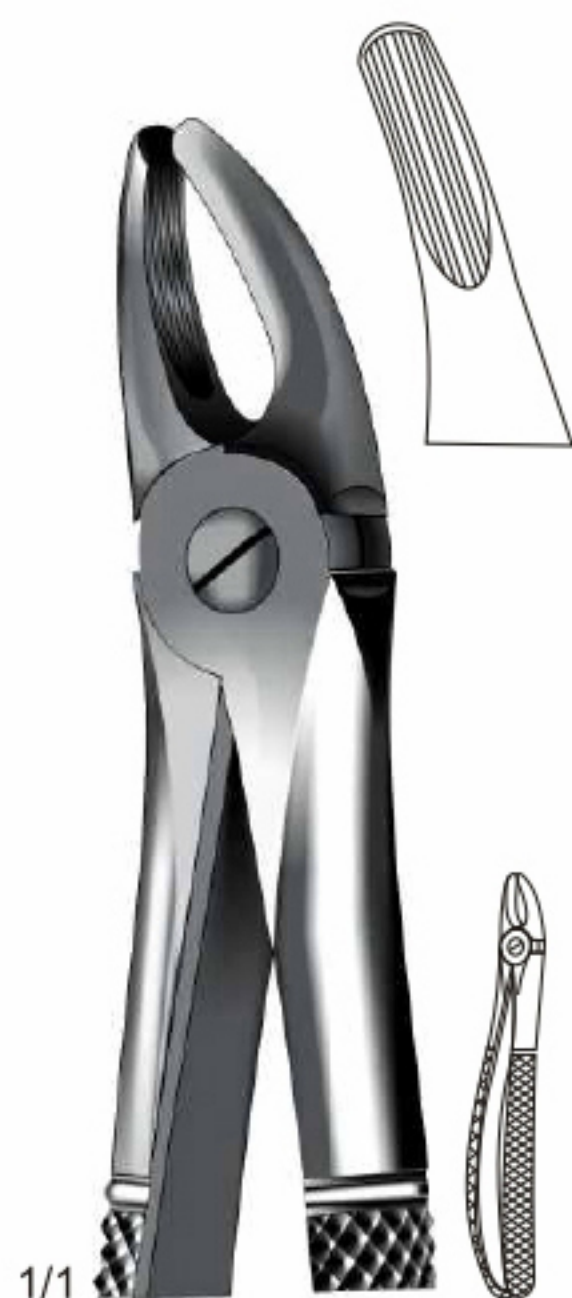

01-0107
Fig.7



01-0108
Fig.8



01-0113
Fig.13

- 01-0101 For Upper Centrals And Canines
- 01-0102 For Upper Laterals And Bicusprds
- 01-0103 For Upper Incisors And Canines
Crowded Internally Or Externally
- 01-0104 For Lower Incisors And Canines
- 01-0107 For Upper Bicuspids Either Side
- 01-0108 For Lower Bicuspids Either Side
- 01-0113 For Lower Bicuspids Either Side



1/1
01-0117
Fig. 17

- 01-0117 For Right Upper Molars
- 01-0118 For Left Upper Molars
- 01-0218 For Upper Molars, Either Side
- 01-0219 For Upper Wisdoms, Either Side
- 01-0220 For Lower Wisdoms, Either Side
- 01-0221 For Lower Molars, Either Side
- 01-0222 For Lower Molars, Either Side (Hawk's Bill)



1/1
01-0118
Fig. 18



01-0218
Fig. 18 A



01-0219
Fig. 19



1/1
01-0220
Fig. 20



01-0221
Fig. 21



01-0222
Fig. 22

All Extracting Dental Forceps are also available in **Non-Slip Grip Jaws**. Please see page 11 for ordering details.



01-0223
Fig. 23



01-0224
Fig. 24

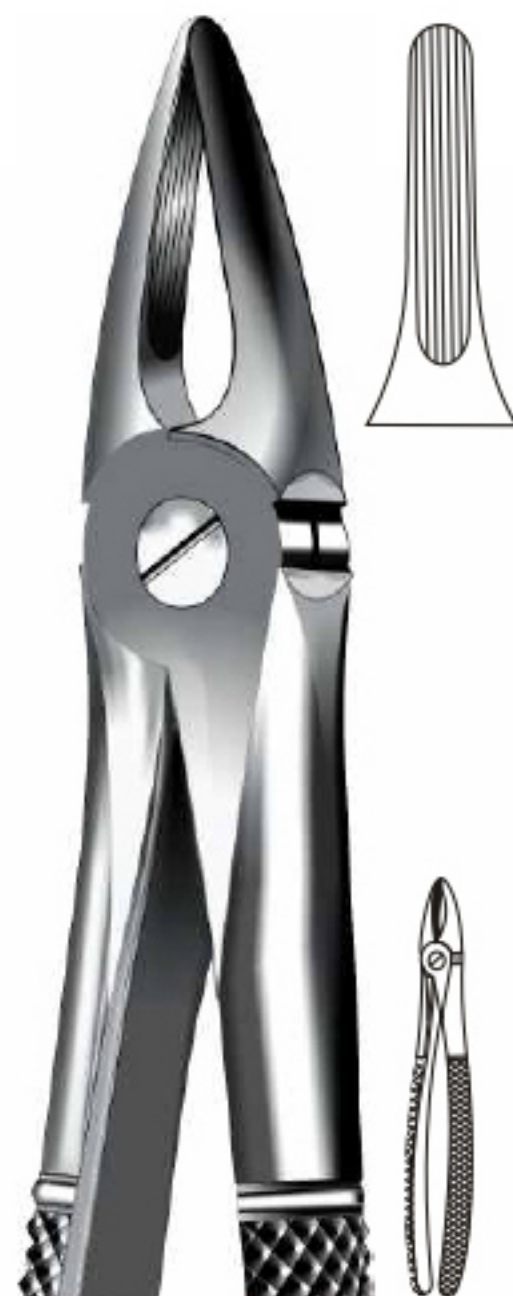

01-0229
Fig. 29



01-0329
Fig. 29 N

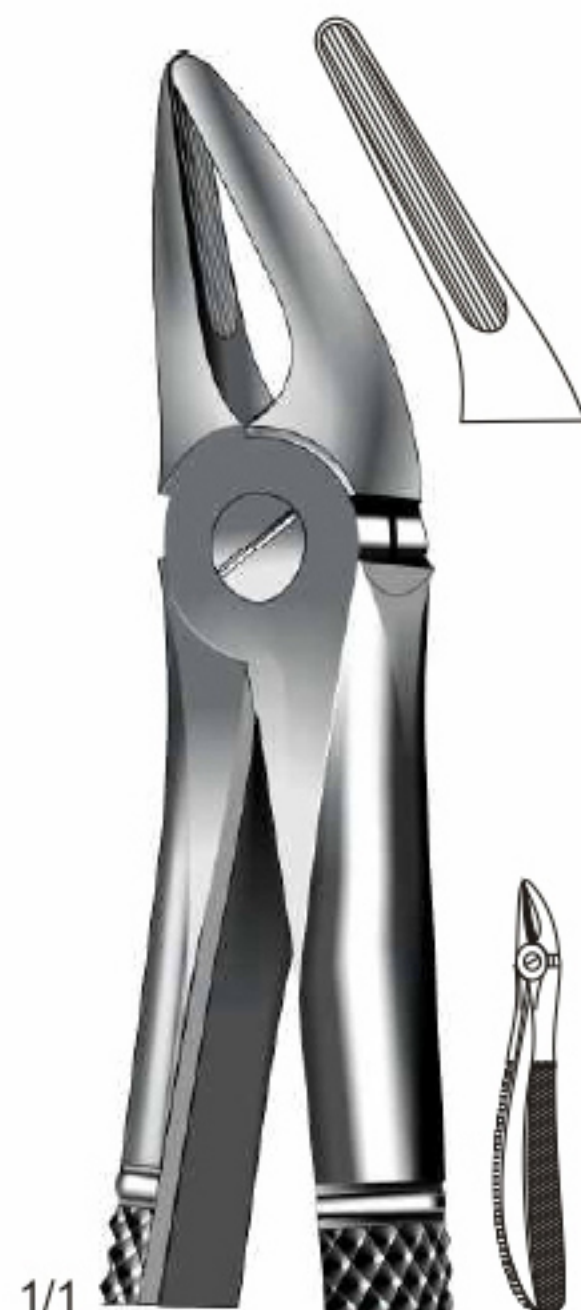

01-0330
Fig. 30



01-0331
Fig. 31



01-0333
Fig. 33



01-0433
Fig. 33 A

- 01-0233 | For Right Lower Molars
- 01-0224 | For Left Lower Molars
- 01-0229 | For Upper Roots And Incisors, Either Side
- 01-0329 | For Roots Of Upper Incisors
- 01-0330 | For Lower Roots And Incisors
- 01-0331 | For Lower Roots, Either Side
- 01-0333 | For Lower Roots, Either Side
- 01-0433 | For Lower Roots, Either Side



01-0533
Fig. 33 C



01-0633
Fig. 33 M



01-0641
Fig. 41



01-0644
Fig. 44



01-0645
Fig. 45

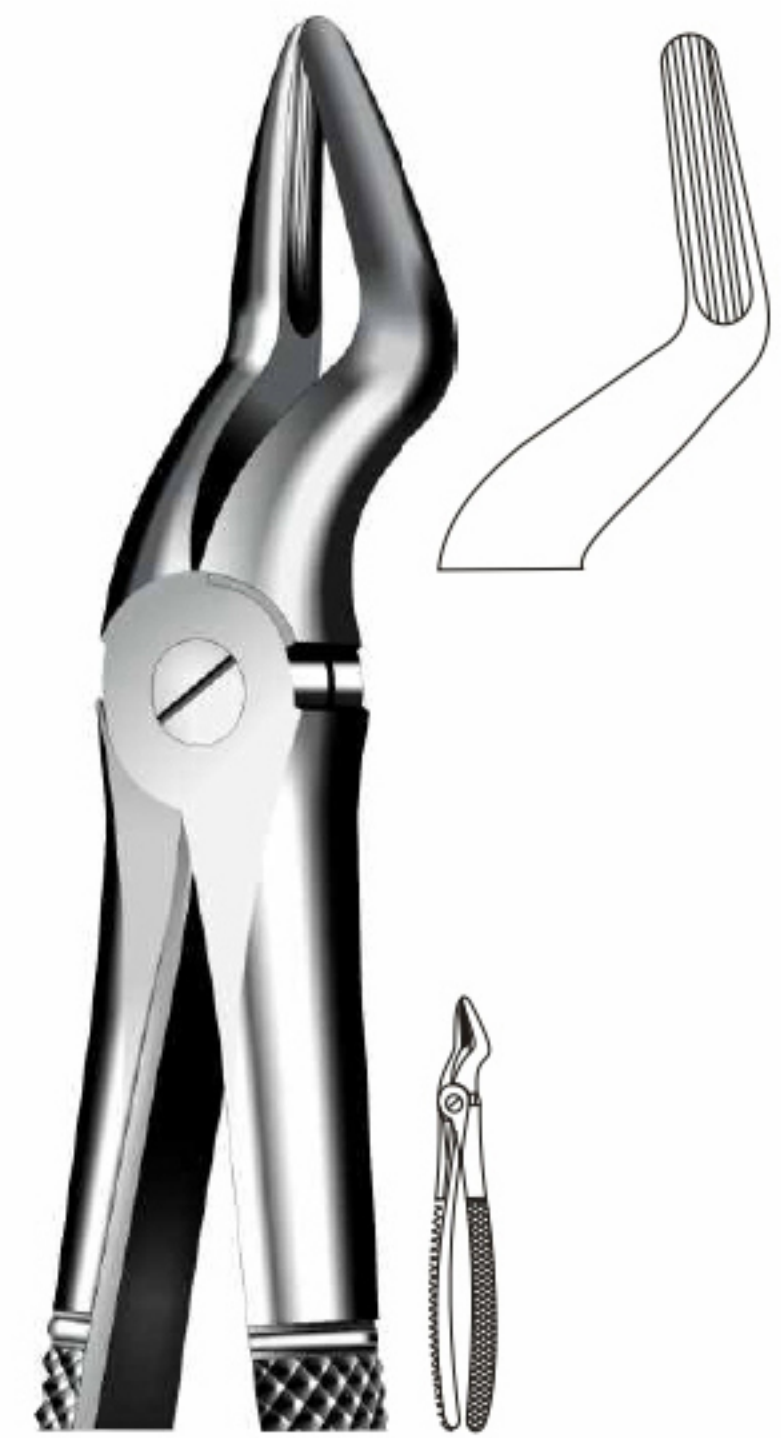

01-0651
Fig. 51

- 01-0533 | For Lower Roots, Either Side, Slender Pattern
- 01-0633 | For Lower Roots, Either Side, Slender Pattern
- 01-0641 | For Upper Roots, Either Side
- 01-0644 | For Upper Roots, Either Side
- 01-0645 | For Lower Roots, Either Side
- 01-0651 | For Upper Roots

All Extracting Dental Forceps are also available in **Non-Slip Grip Jaws**.
Please see page 11 for ordering details.

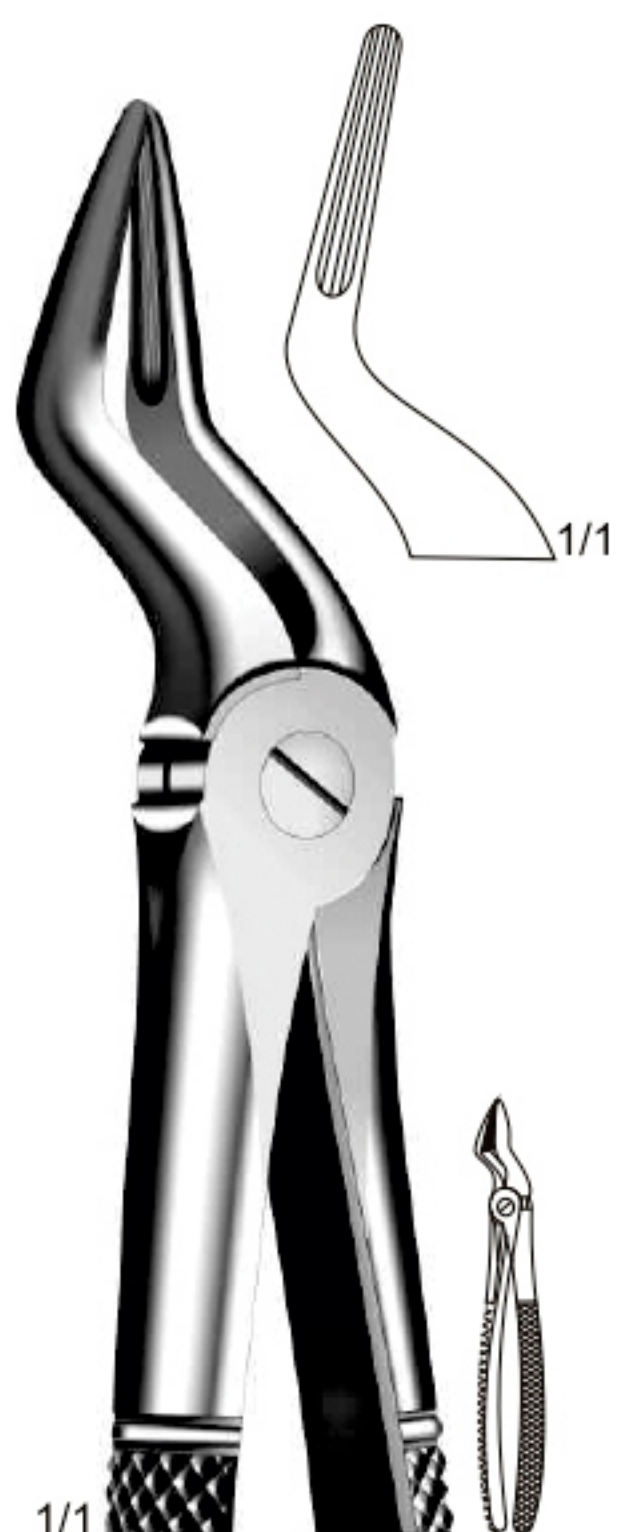

01-0751
Fig. 51 A

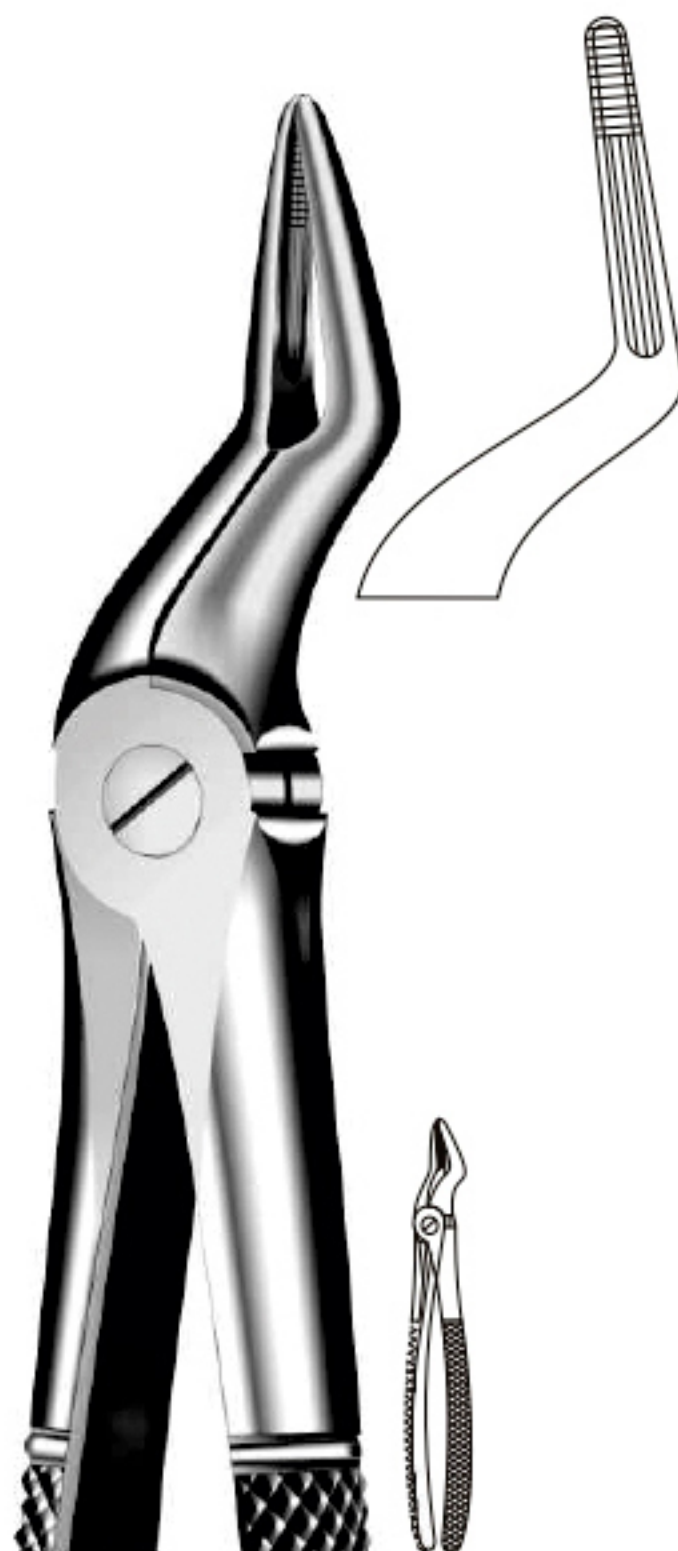

01-0851
Fig. 51 C

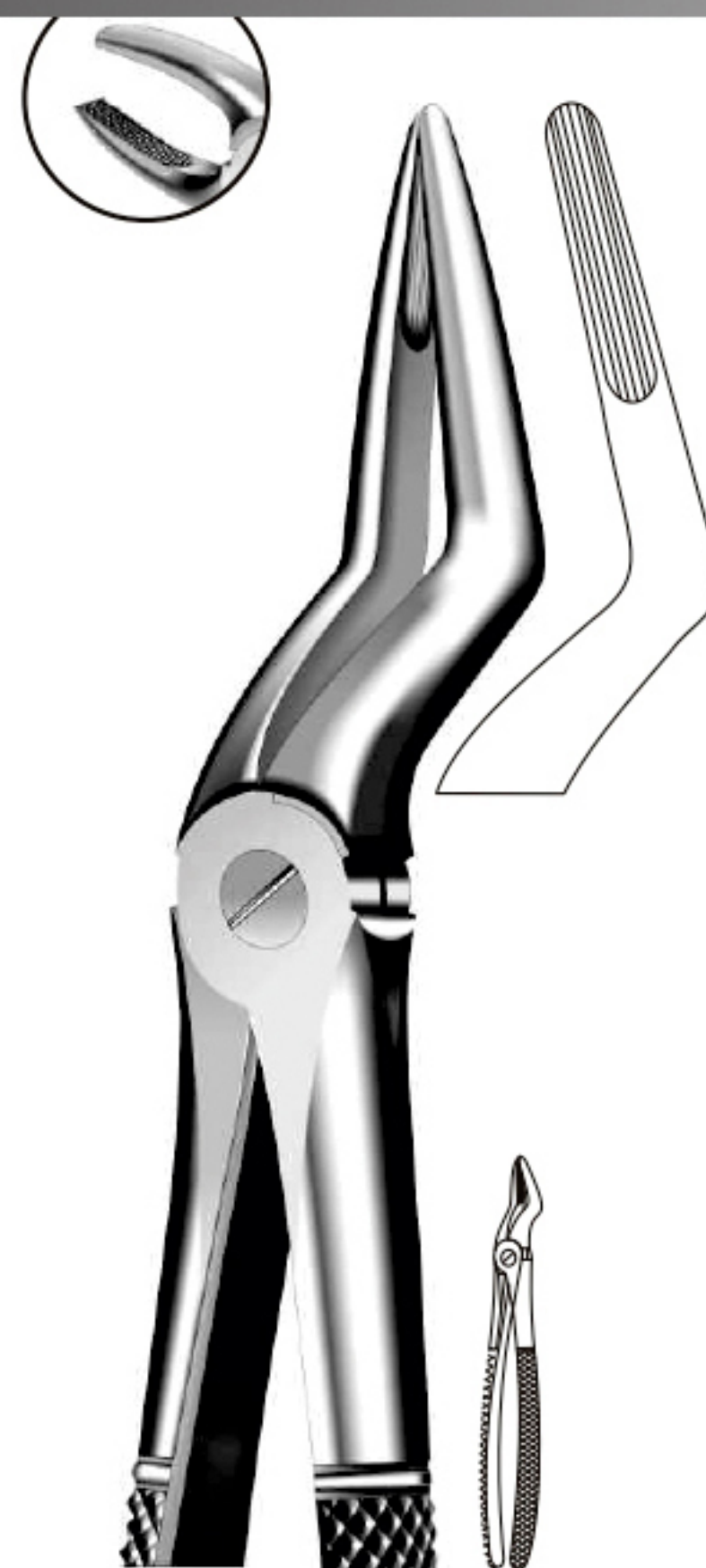

Mod. Pro
01-0951
Fig. 51 M

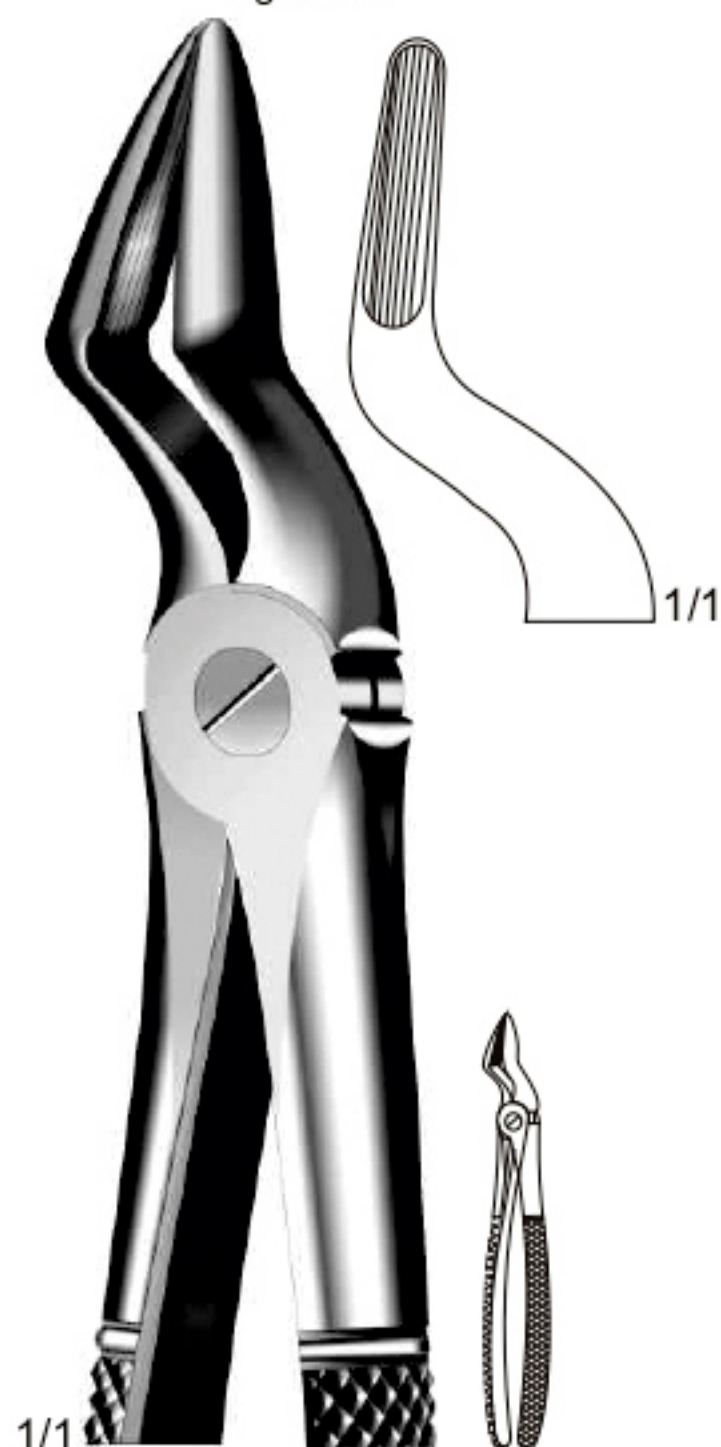

01-0952
Fig. 52

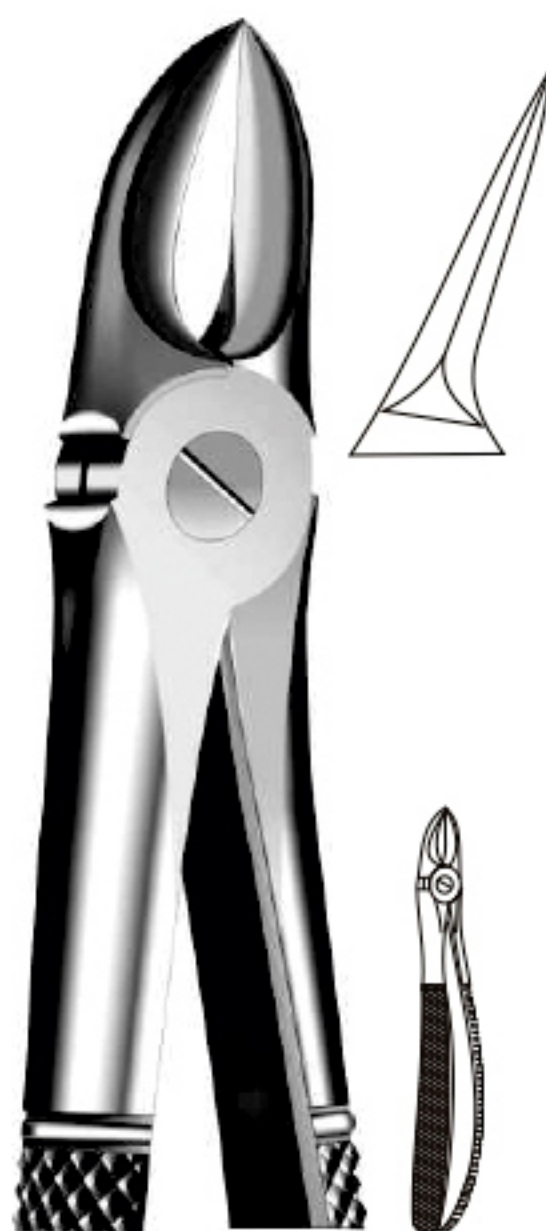

01-0955
Fig. 55

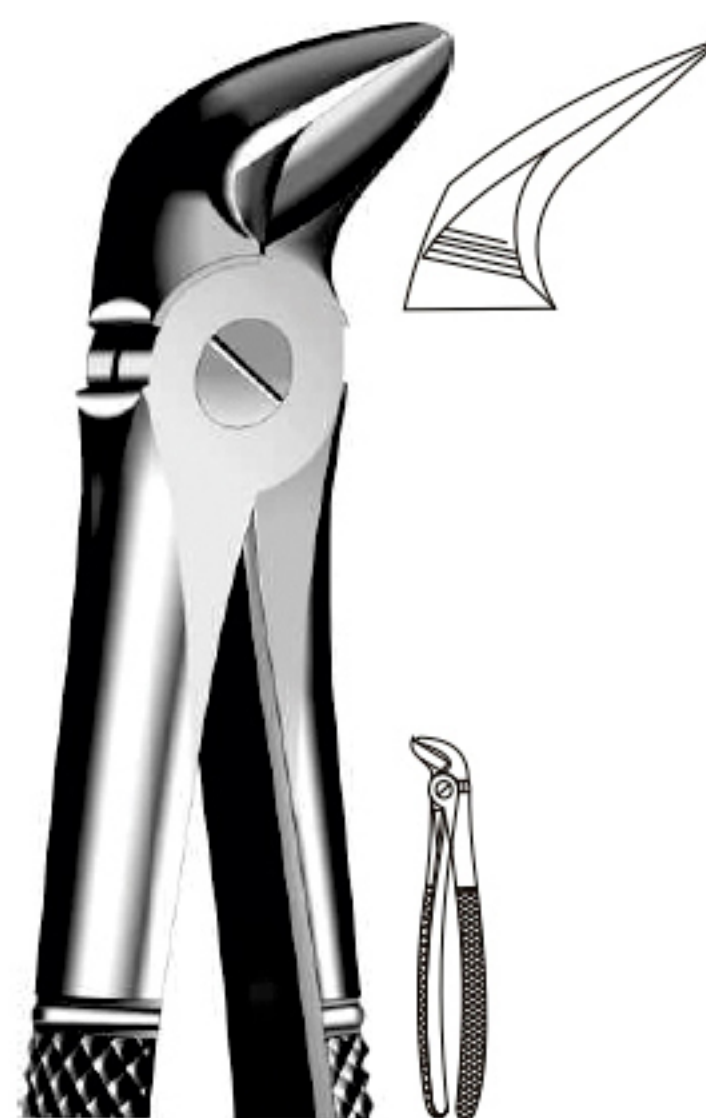

01-0956
Fig. 56

- 01-0751 For Upper Roots, Very Narrow Beak
- 01-0851 For Upper Roots
- 01-0951 For Upper Roots With Very Long Beak For Deep Upper Roots
- 01-0952 For Upper Roots And Canines, With Wider Beak
- 01-0955 For Separating Upper Molar
- 01-0956 For Separating Lower Molar

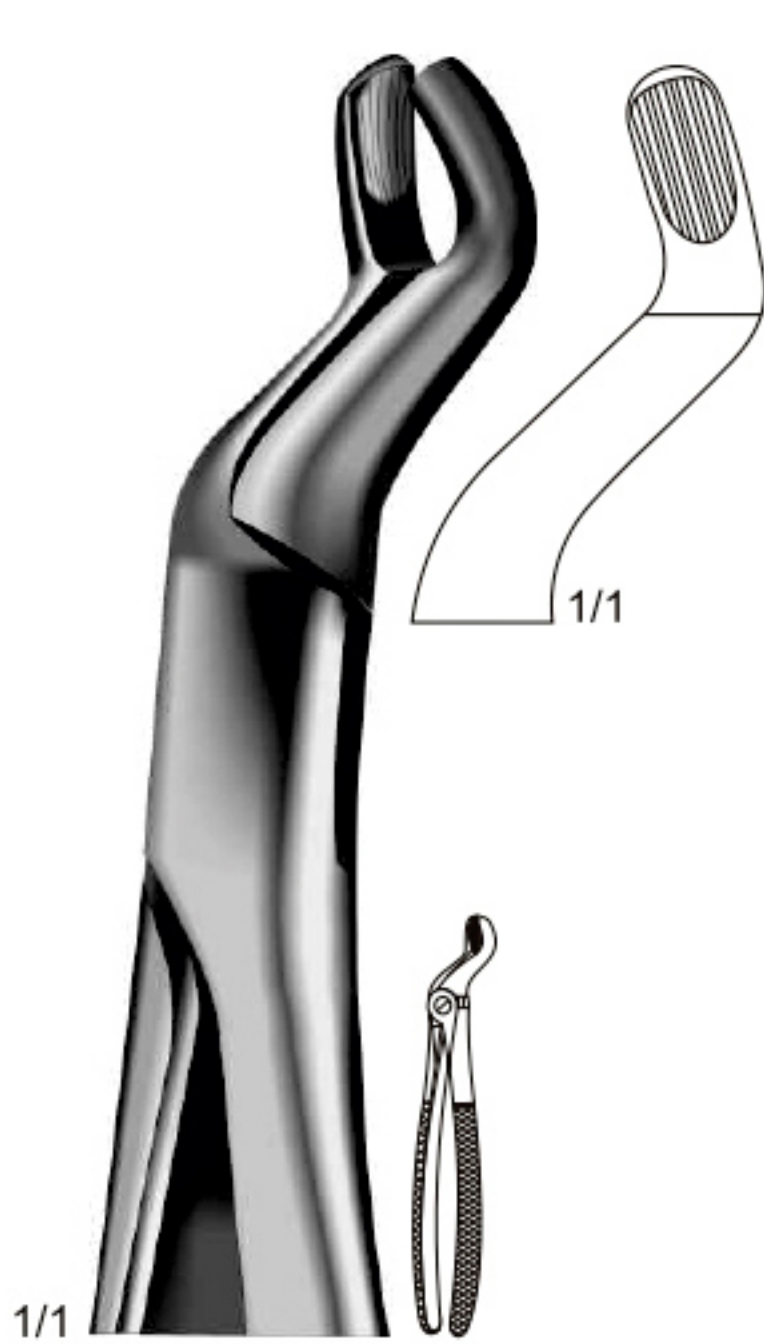

01-0967
Fig. 67

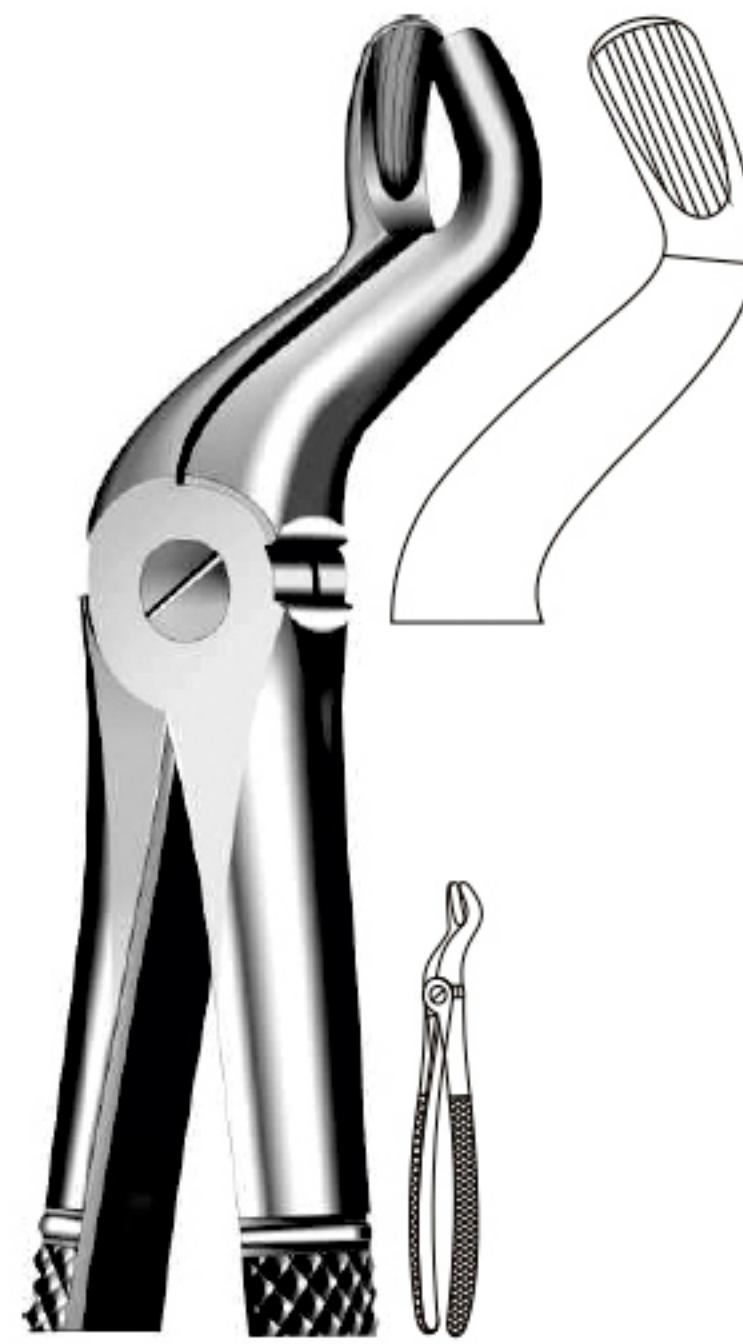

01-1067
Fig. 67 A



01-1073
Fig. 73

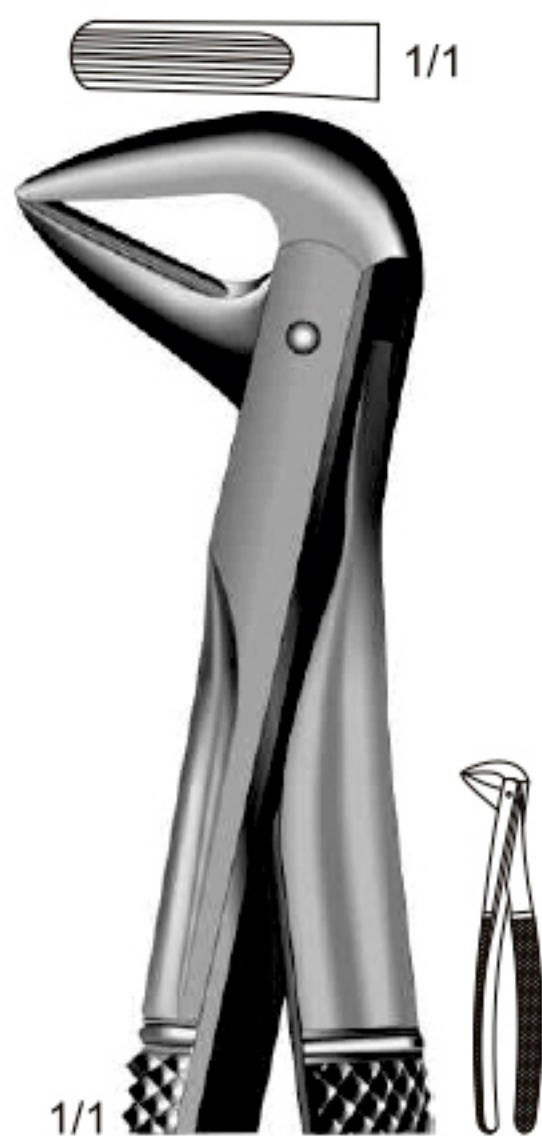

01-1074
Fig. 74



01-1174
Fig. 74 M



01-1274
Fig. 74 N



01-1275
Fig. 75

- 01-0967 For Upper Wisdoms, Either Side
- 01-1067 For Upper Wisdoms, Either Side
- 01-1073 For Lower Molars, Either Side (Hawk's Bill)
- 01-1074 For Lower Incisors And Roots
- 01-1174 For Lower Incisors And Roots
- 01-1274 For Lower Incisors And Roots
- 01-1275 For Lower Bicuspid And Canines (either Side)

All Extracting Dental Forceps are also available in Non-Slip Grip Jaws. Please see page 11 for ordering details.

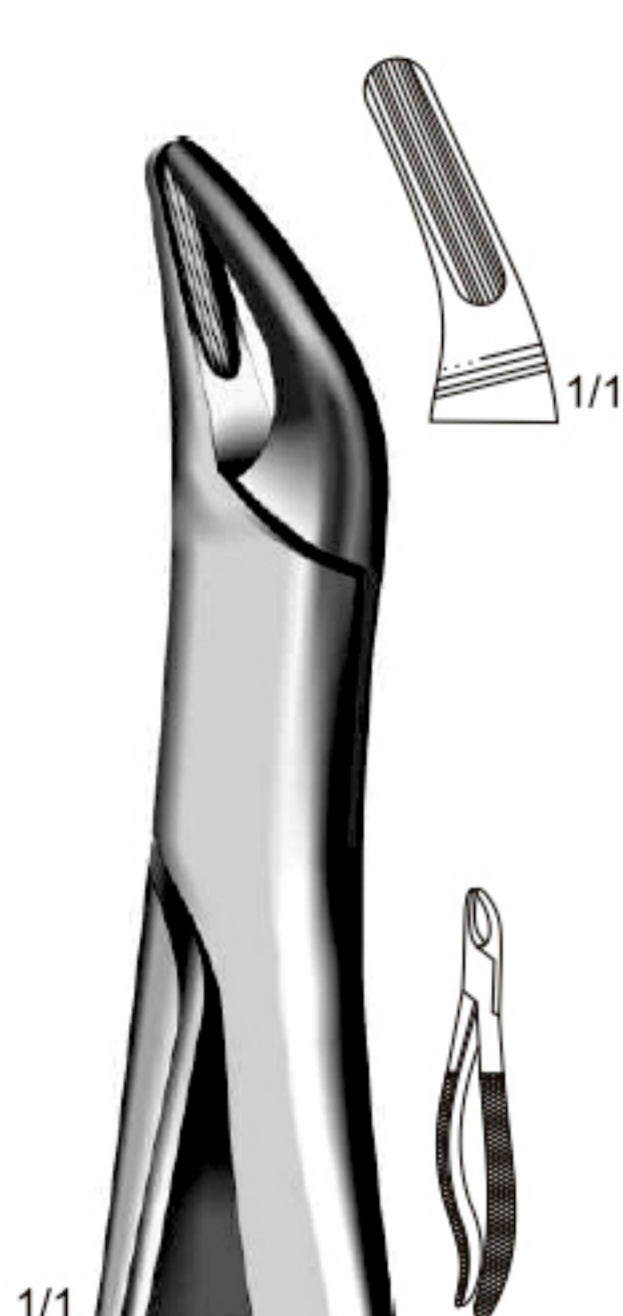

Lowrence Read
01-1276
Fig. 76



Lowrence Read
01-1376
Fig. 76 N



01-1379
Fig. 79



01-1479
Fig. 79 A



01-1486
Fig. 86 A



01-1586
Fig. 86 B



01-1686
Fig. 86 C



01-1687
Fig. 87

- 01-1276 For Upper Roots, Either Side
- 01-1376 For Upper Roots, Either Side (with Narrow Beak)
- 01-1379 For Lower Wisdoms (either Side)
- 01-1479 For Lower Wisdoms (either Side)
- 01-1486 For Lower Molar With Decayed Or Broken Down Crowns, Either Side
- 01-1586 For Lower Molar With Decayed Or Broken Down Crowns, Either Side
- 01-1686 For Lower Molar With Decayed Or Broken Down Crowns, Either Side
- 01-1687 For Lower Molar With Decayed Or Broken Down Crowns, Either Side

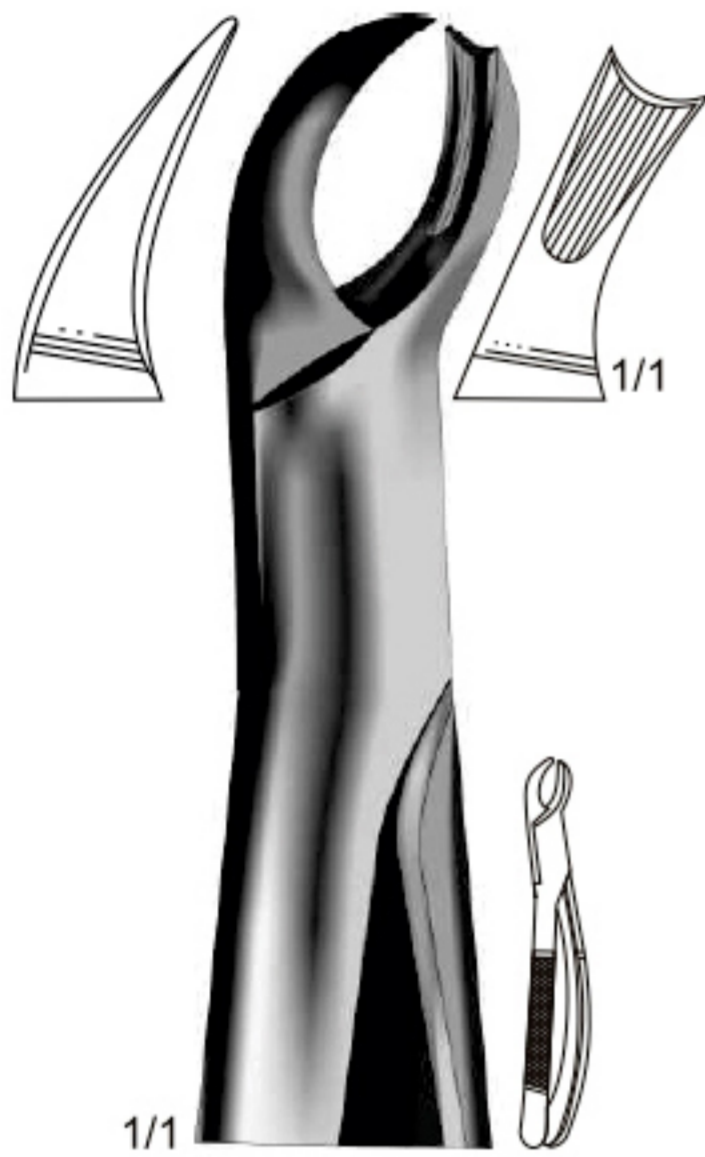

01-1689
Fig. 89



01-1690
Fig. 90

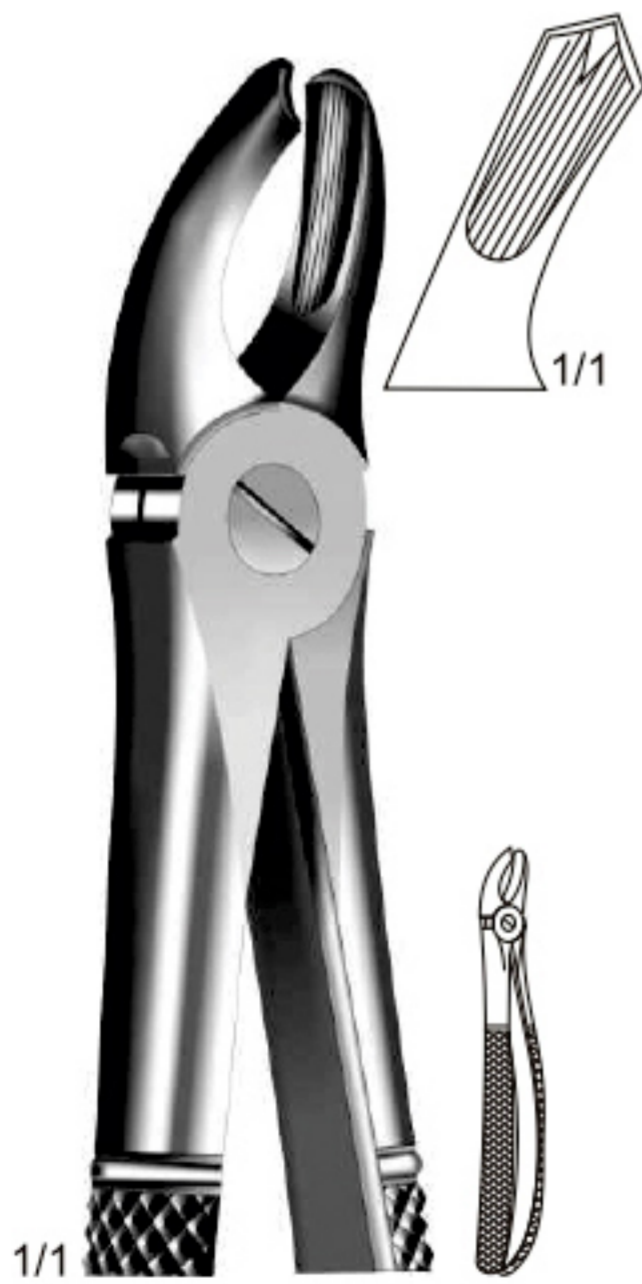

01-1694
Fig. 94

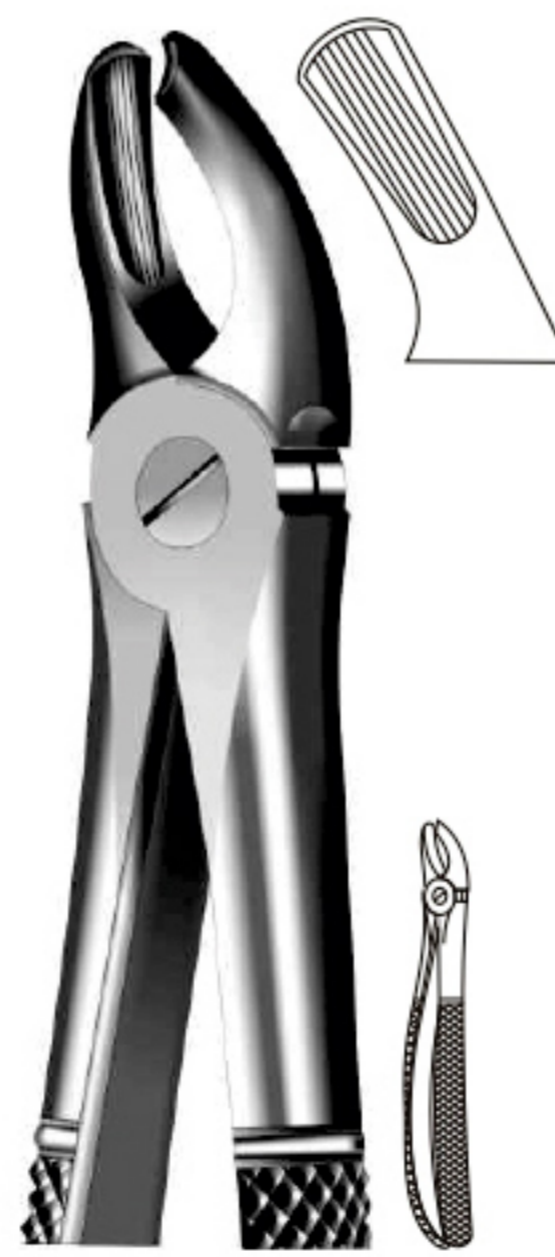

01-1695
Fig. 95



01-1699
Fig. 99

- 01-1689 | For Right Upper Molars
- 01-1690 | For Left Upper Molars
- 01-1694 | For Right Upper Molars
- 01-1695 | For Left Upper Molars
- 01-1699 | For Broken Down Lower Molar

All Extracting Dental Forceps are also available in **Non-Slip Grip Jaws**.
Please see page next for ordering details.



Mead
01-1701
Fig. MD 1



Mead
01-1702
Fig. MD 2



Mead
01-1703
Fig. MD 3



Mead
01-1704
Fig. MD 4

- 01-1701 | Universal Forceps For Upper Wisdoms, Bicuspid And Upper Roots
- 01-1702 | For Upper Molars
- 01-1703 | For Lower Incisors, Bicuspid And Roots
- 01-1704 | For Lower Molars

Extracting Forceps with Alpha handle



Alpha handle

All preceding extracting forceps in English pattern are also available with **Alfa handle**.

Just replace first two article numbers, "01-" with "02-". Please refer to column "C" below.

Article numbers

A			B			C		
Normal handle	Non-Slip Grip	Alfa handle	Normal handle	Non-Slip Grip	Alfa handle	Normal handle	Non-Slip Grip	Alfa handle
01-0101	01-0101 NS	02-0101	01-0333	01-0333 NS	02-0333	01-1376	01-1376 NS	02-1376
01-0102	01-0102 NS	02-0102	01-0433	01-0433 NS	02-0433	01-1379	01-1379 NS	02-1379
01-0104	01-0104 NS	02-0104	01-0533	01-0533 NS	02-0533	01-1479	01-1479 NS	02-1479
01-0107	01-0107 NS	02-0107	01-0633	01-0633 NS	02-0633	01-1486	01-1486 NS	02-1486
01-0108	01-0108 NS	02-0108	01-0641	01-0641 NS	02-0641	01-1586	01-1586 NS	02-1586
01-0113	01-0113 NS	02-0113	01-0644	01-0644 NS	02-0644	01-1686	01-1686 NS	02-1686
01-0117	01-0117 NS	02-0117	01-0645	01-0645 NS	02-0645	01-1687	01-1687 NS	02-1687
01-0118	01-0118 NS	02-0118	01-0651	01-0651 NS	02-0651	01-1689	01-1689 NS	02-1689
01-0218	01-0218 NS	02-0218	01-0751	01-0751 NS	02-0751	01-1690	01-1690 NS	02-1690
01-0219	01-0219 NS	02-0219	01-0851	01-0851 NS	02-0851	01-1694	01-1694 NS	02-1694
01-0220	01-0220 NS	02-0220	01-0951	01-0951 NS	02-0951	01-1695	01-1695 NS	02-1695
01-0221	01-0221 NS	02-0221	01-0952	01-0952 NS	02-0952	01-1699	01-1699 NS	02-1699
01-0222	01-0222 NS	02-0222	01-0955	01-0955 NS	02-0955	01-1701	01-1701 NS	02-1701
01-0223	01-0223 NS	02-0223	01-0956	01-0956 NS	02-0956	01-1702	01-1702 NS	02-1702
01-0224	01-0224 NS	02-0224	01-1074	01-1074 NS	02-1074	01-1703	01-1703 NS	02-1703
01-0229	01-0229 NS	02-0229	01-1174	01-1174 NS	02-1174	01-1704	01-1704 NS	02-1704
01-0329	01-0329 NS	02-0329	01-1274	01-1274 NS	02-1274			
01-0330	01-0330 NS	02-0330	01-1275	01-1275 NS	02-1275			
01-0331	01-0331 NS	02-0331	01-1276	01-1276 NS	02-1276			

Non-Slip Grip Jaws



All preceding extracting forceps in English pattern are also available in **Non-Slip Grip Jaws**.

Please add "NS" with existing article numbers. e.g **01-0101NS**. Please refer to column B.



03-1837
Fig. 37
For upper incisors
and canines



03-1813
Fig. 13 S
For lower bicusps, either side



03-1822
Fig. 22 S
For lower molars, either side

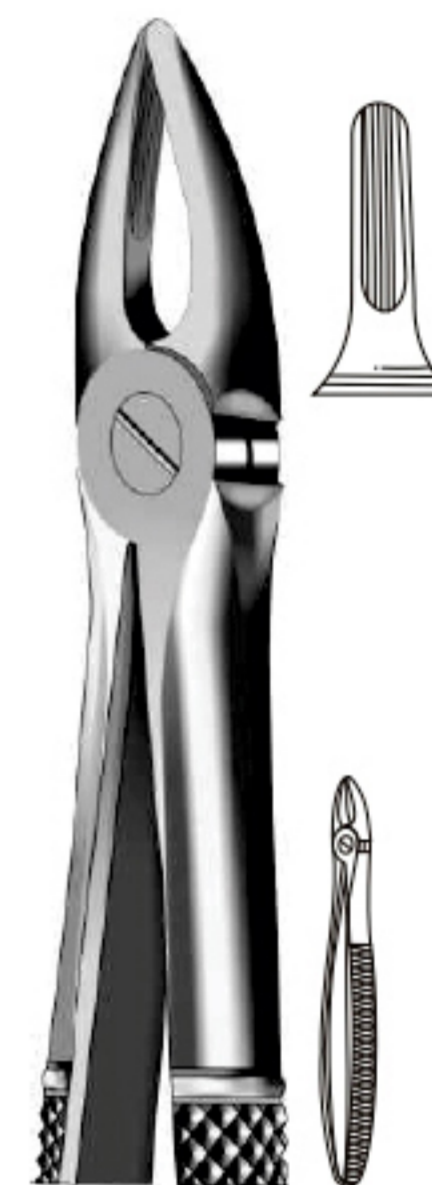

03-1829
Fig. 29 S



03-1830
Fig. 30 S
For upper incisors and roots,
either side



03-1833
Fig. 33 S
For lower roots, either side



03-1838
Fig. 38
For lower incisors and canines

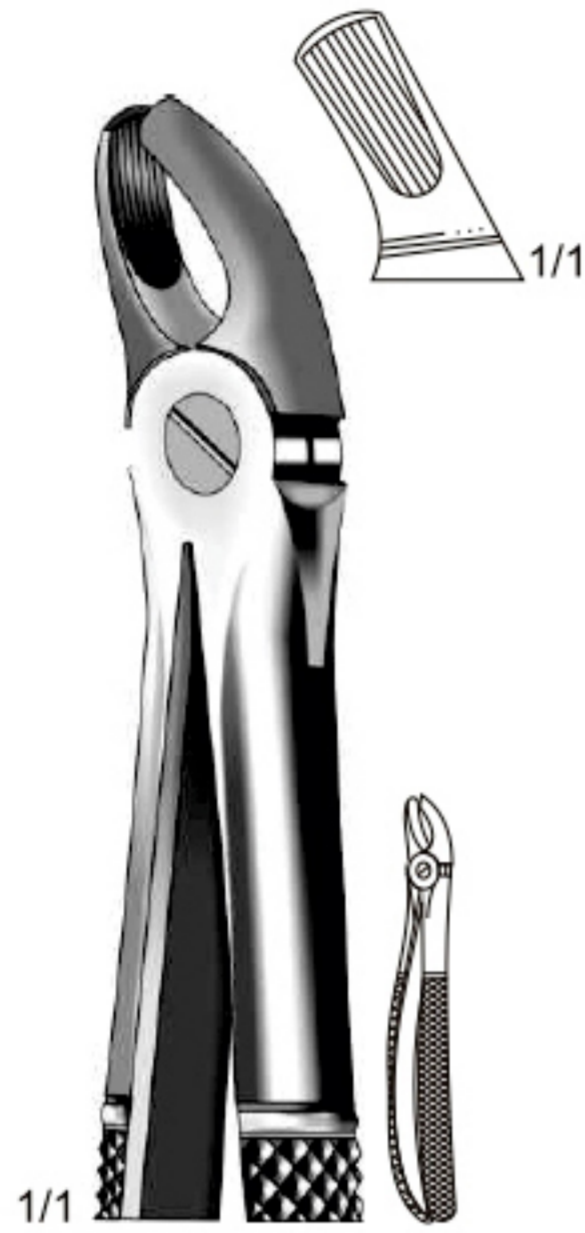

03-1839
Fig. 39
For upper molars, either side

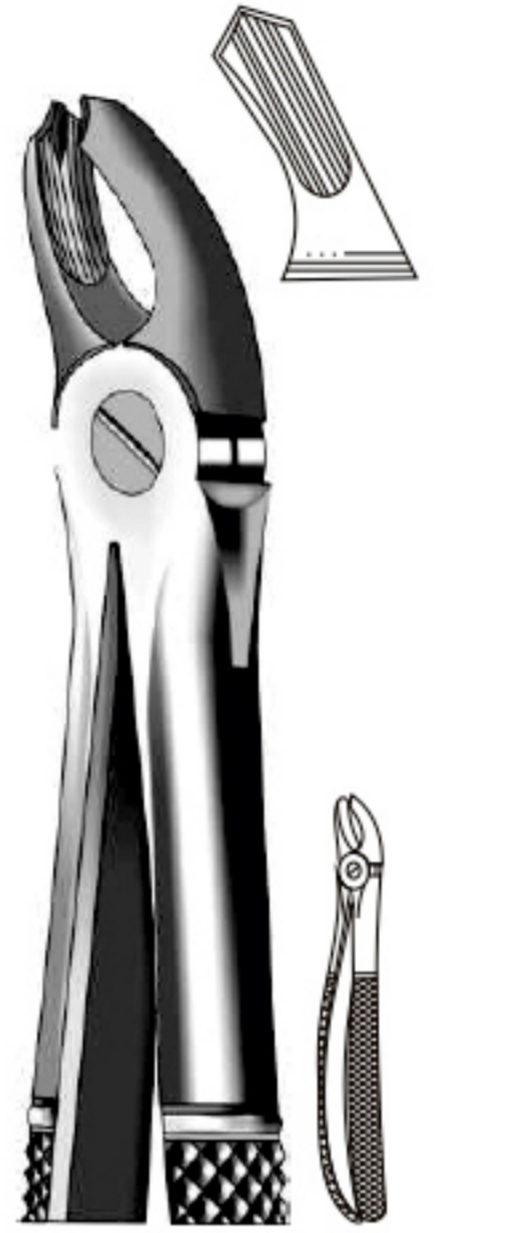

03-1939
Fig. 39 A
For upper molars, either side



03-2039
Fig. 39 L
For left upper molar



- 03-1810**
Instrument set of 10
- | | |
|---------|---------|
| 03-1837 | 03-1813 |
| 03-1839 | 03-1830 |
| 03-2139 | 03-1833 |
| 03-2039 | 03-1822 |
| 03-2151 | 03-1838 |



03-2139
Fig. 39 R
For right upper molar

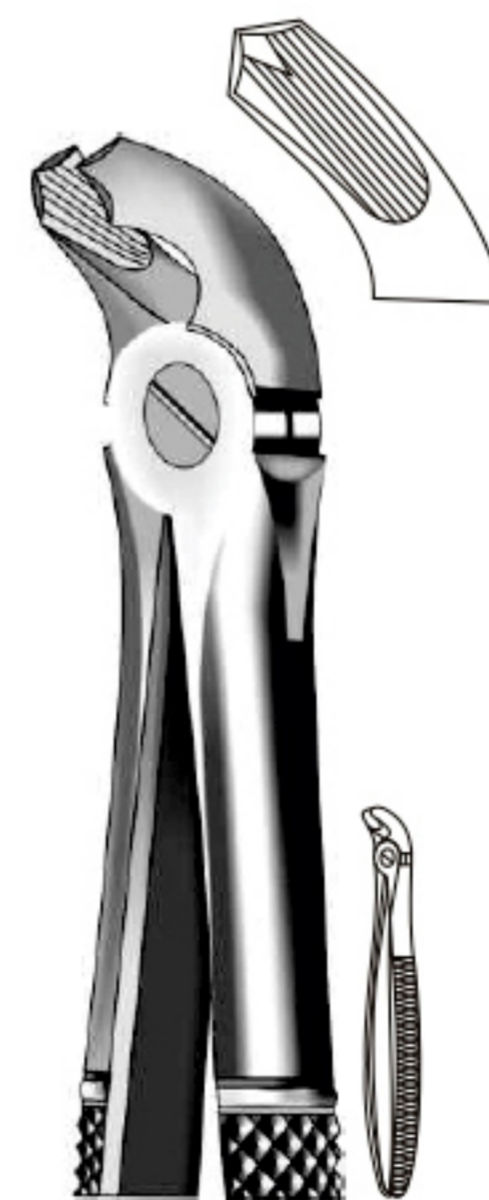

03-2140
Fig. 40
For lower molars, either side

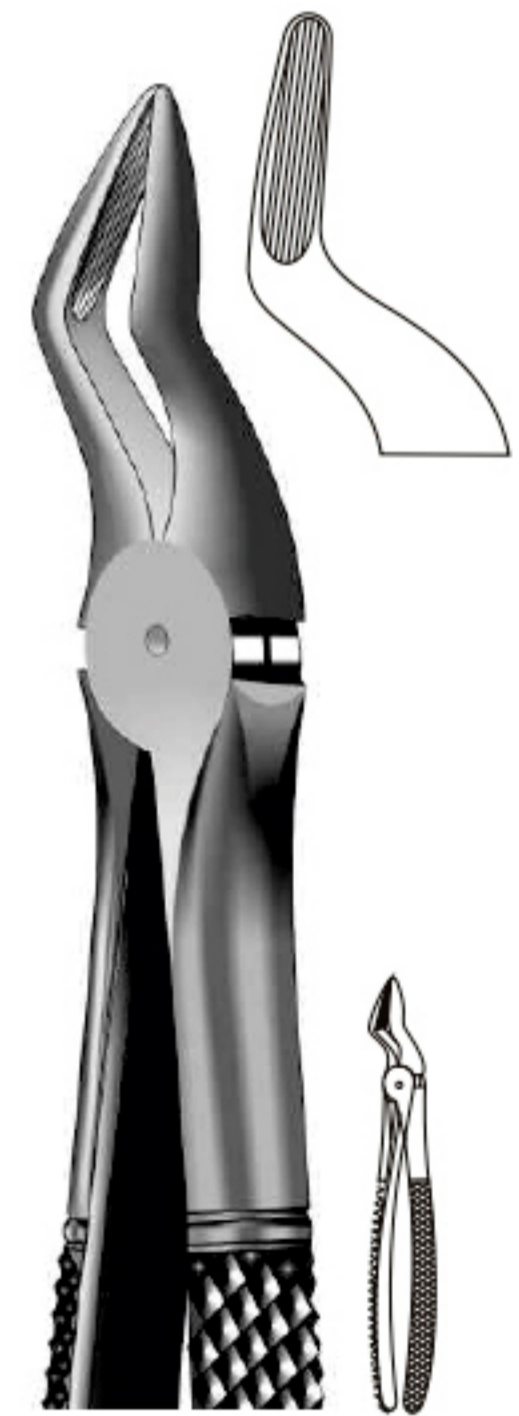

03-2151
Fig. 51 S
For upper roots, either side



Klein
03-2203
Fig. 3
For upper molars

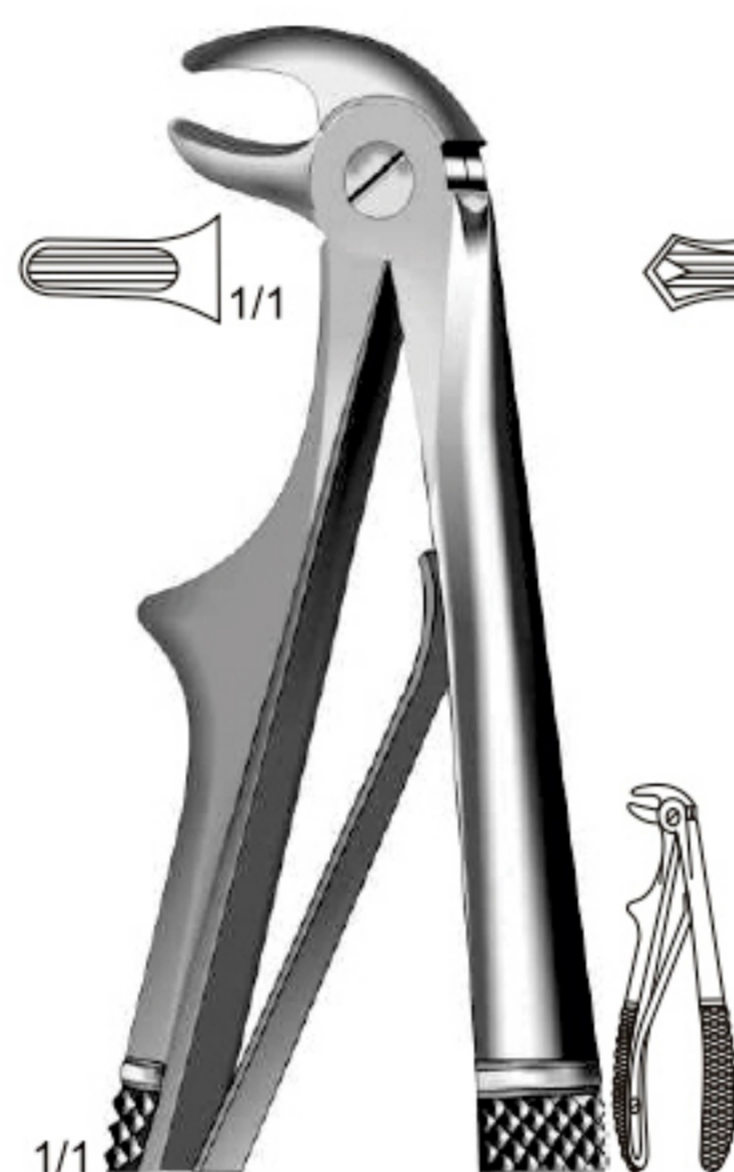

Klein
03-2205
Fig. 5
For lower incisors

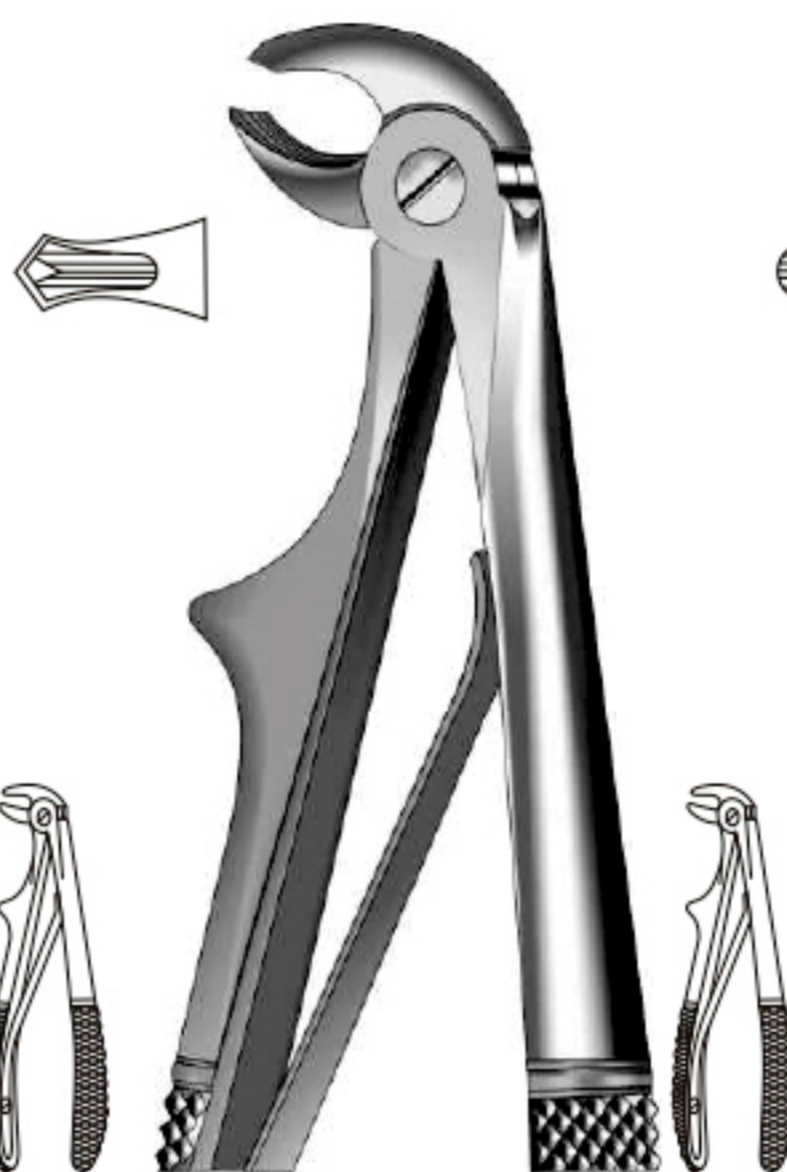

Klein
03-2206
Fig. 6
For lower molars

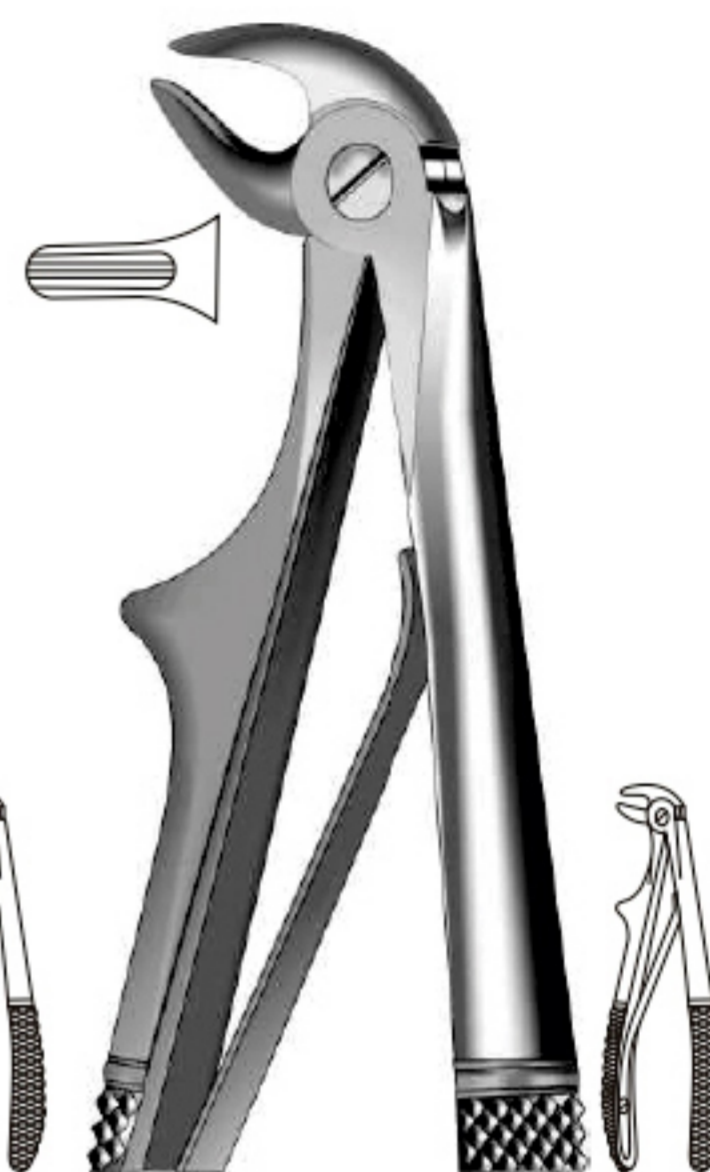

Klein
03-2207
Fig. 7
For lower roots

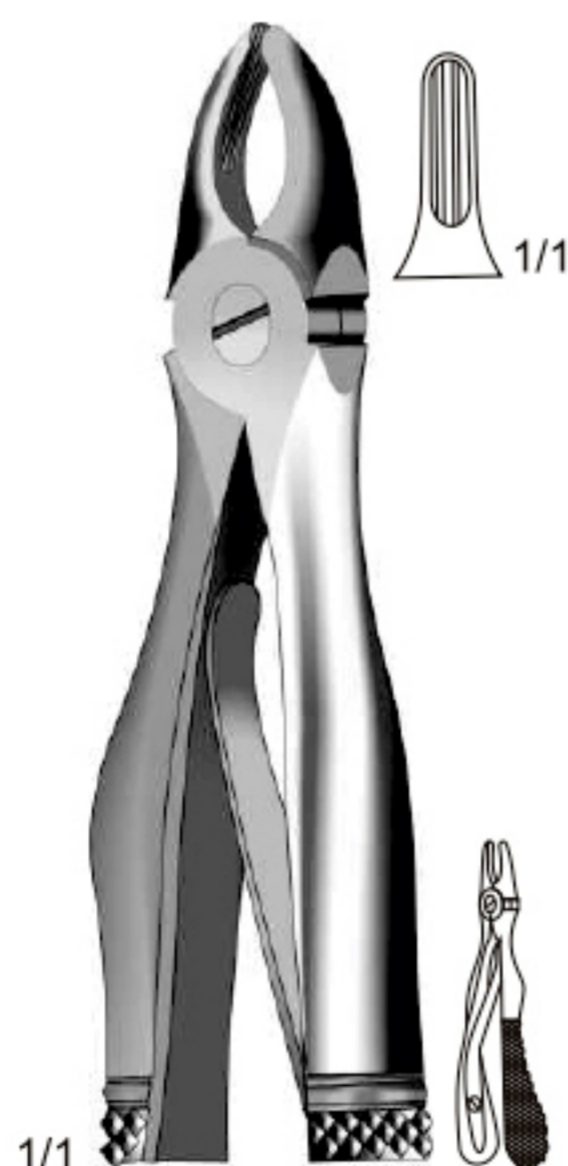

Klein
03-3137
Fig. 137
For upper incisors & canines



Klein
03-3139
Fig. 139
For upper bicuspid



Klein
03-3151
Fig. 51 S
For upper roots

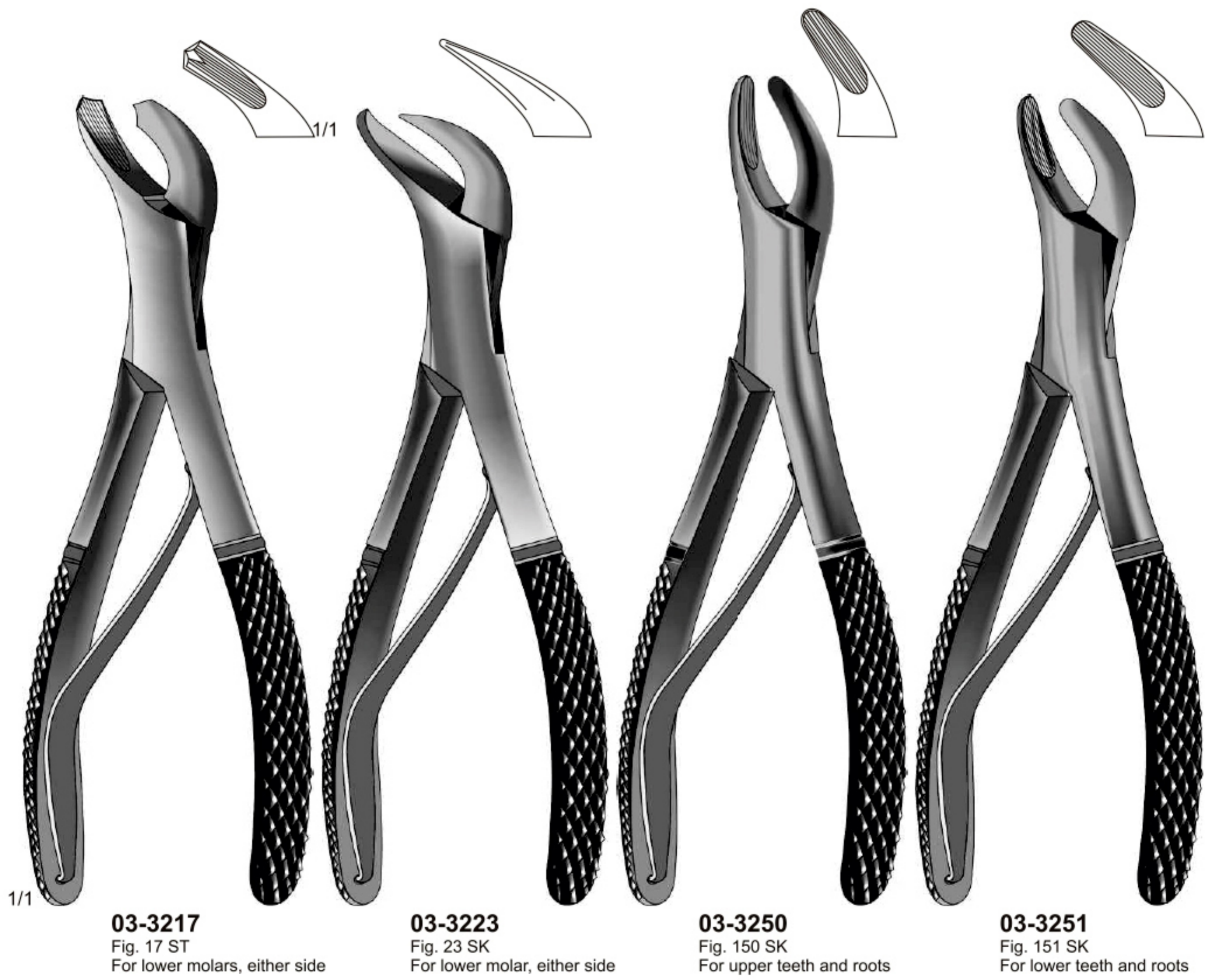



Standard
04-0101
Fig. 1
For upper centrals,
laterals and cuspids



Henahan
04-0201
Fig. 1 A
For upper incisors



Physick
04-0205
Fig. 5
For lower third molars
either side



04-0206
Fig. 6
Splitting or separating
forceps

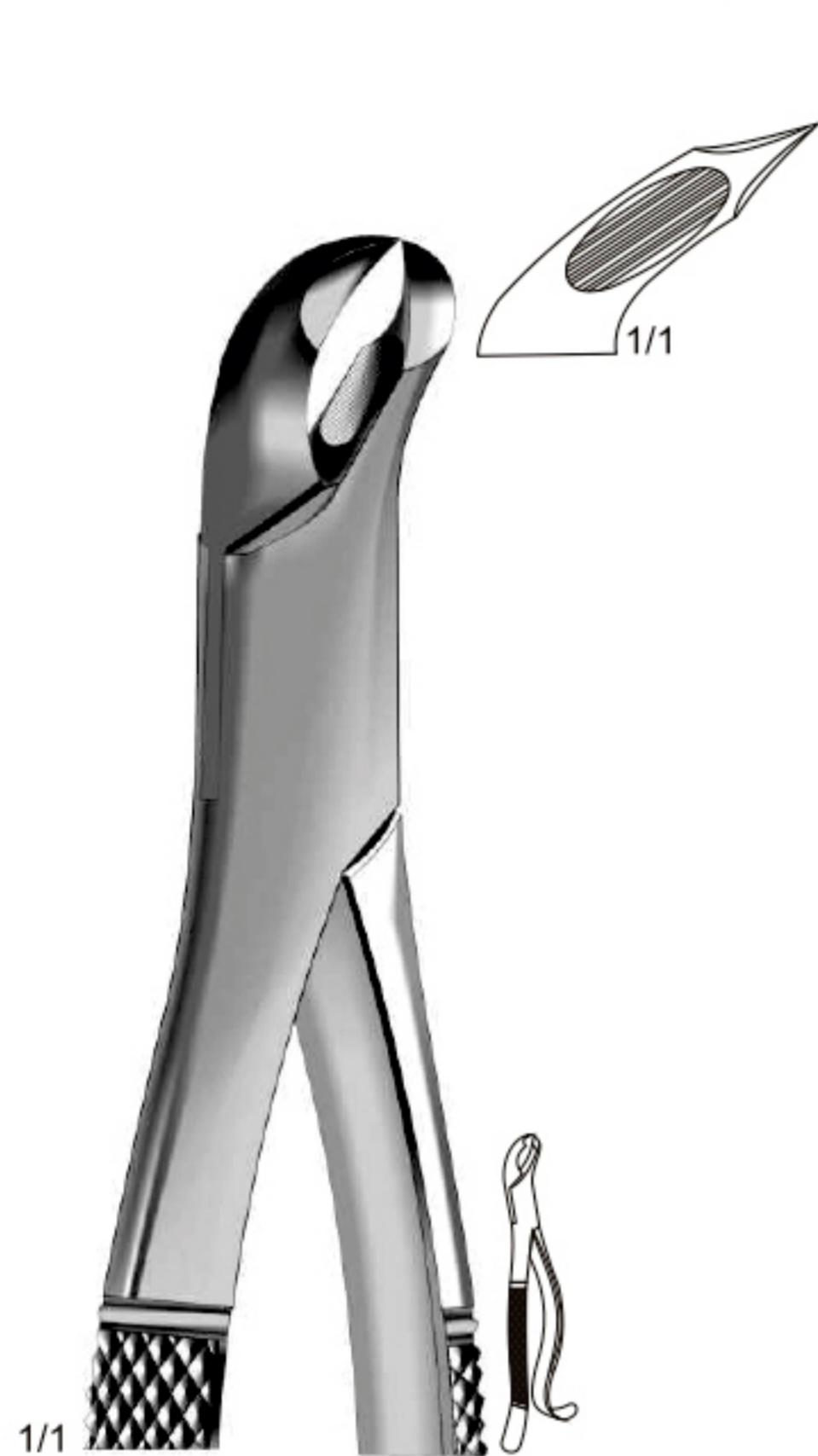

Woodward
04-0203
Fig. 3 FH
For lower molars



04-0310 - 04-0410
Fig. 10 H / Fig. 10 S
For upper molars, either side

04-0310
Fig. 10 H

04-0410
Fig. 10 S



Harris
04-0415
Fig. 15



04-0416
Fig. 16
For lower molars

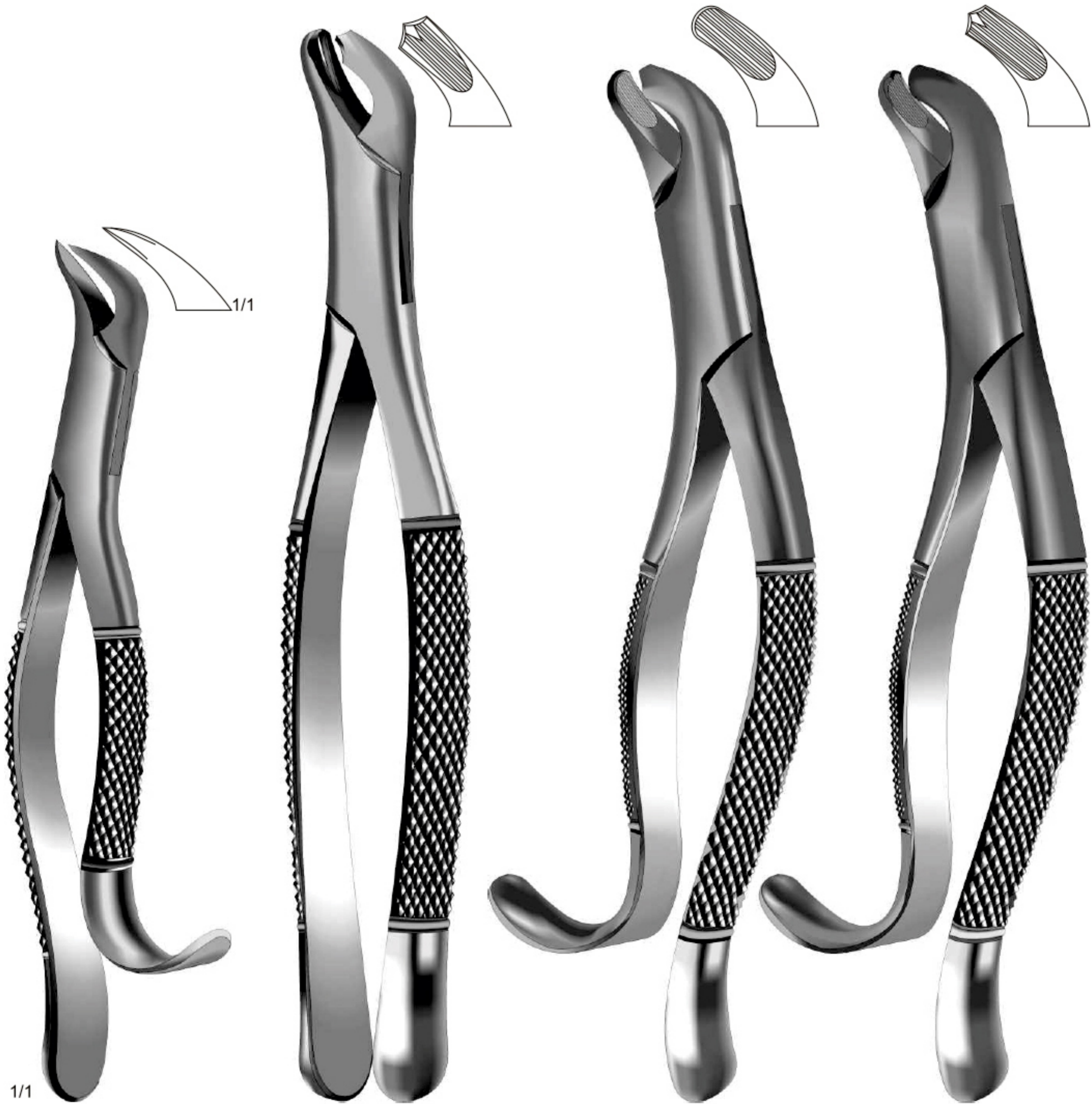

04-0516
Fig .16 S

04-0517
Fig .17

Harris 04-0618
Fig .18 L

Harris 04-0718
Fig .18 R

- 04-0516 | For Lower Molars, Either Side, For Children
- 04-0517 | For Lower Molars, Either Side
- 04-0618 | For Upper Molars, Left Side
- 04-0718 | For Upper Molars, Right Side



04-0723
Fig. 23
For lower molars, either side

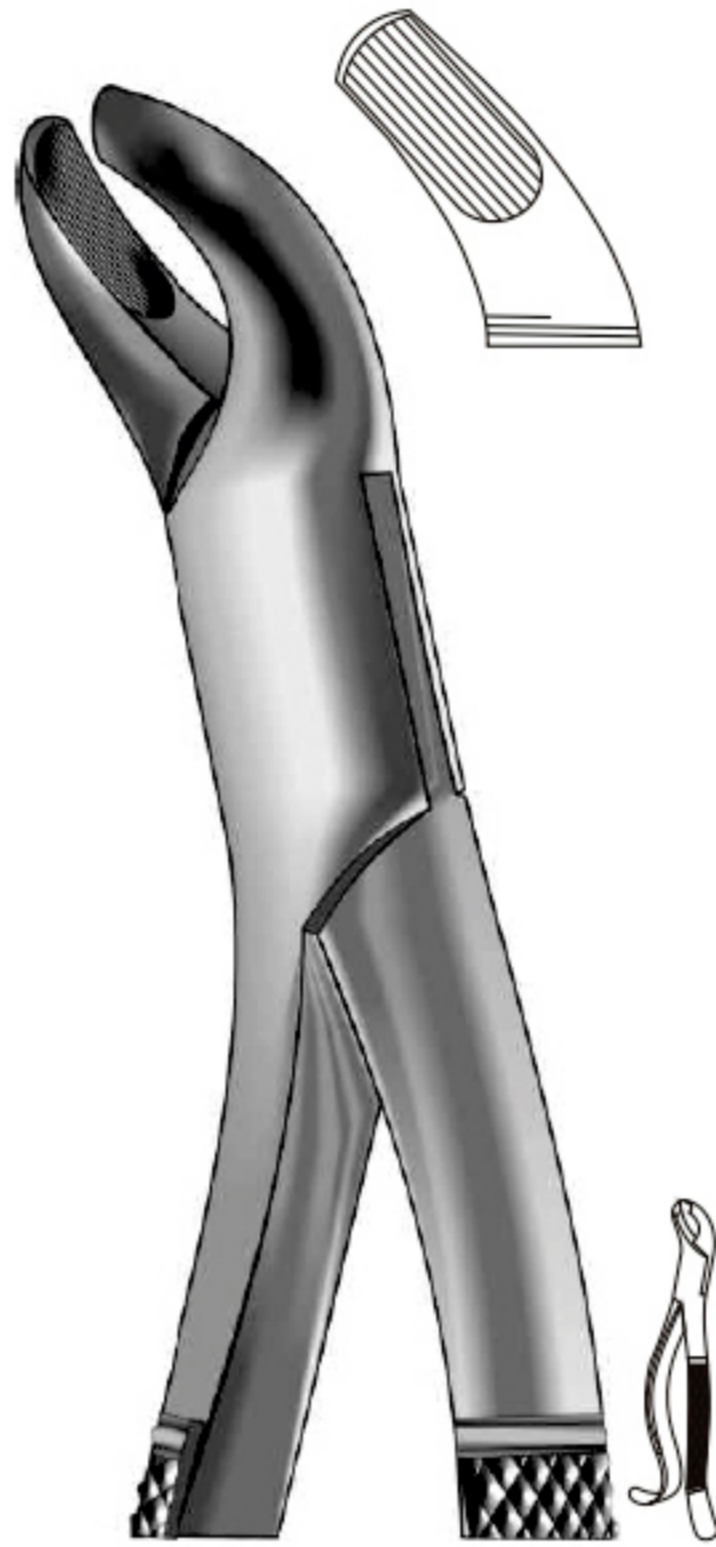

04-0724
Fig. 24
For upper molars, either side

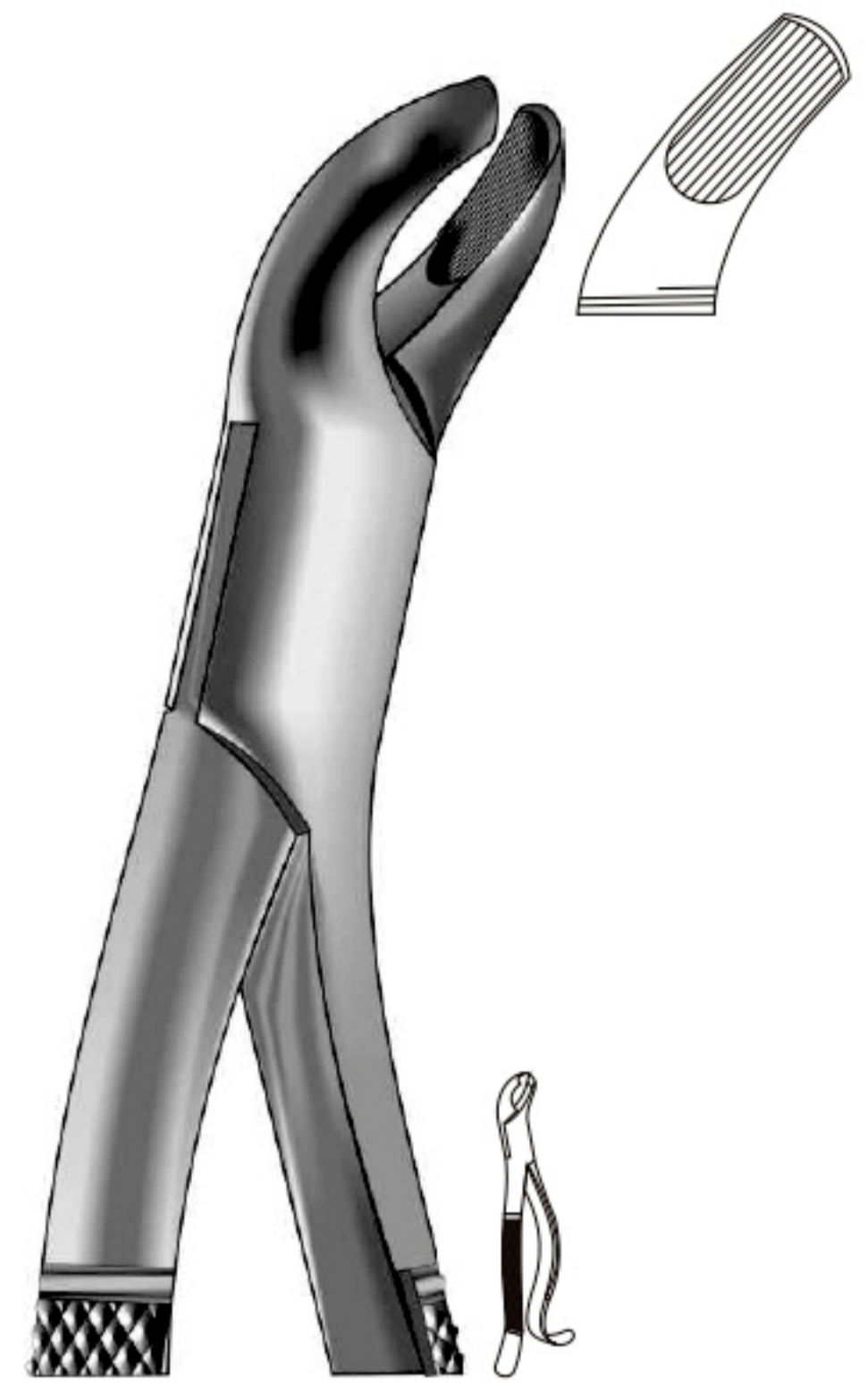

04-0727
Fig. 27

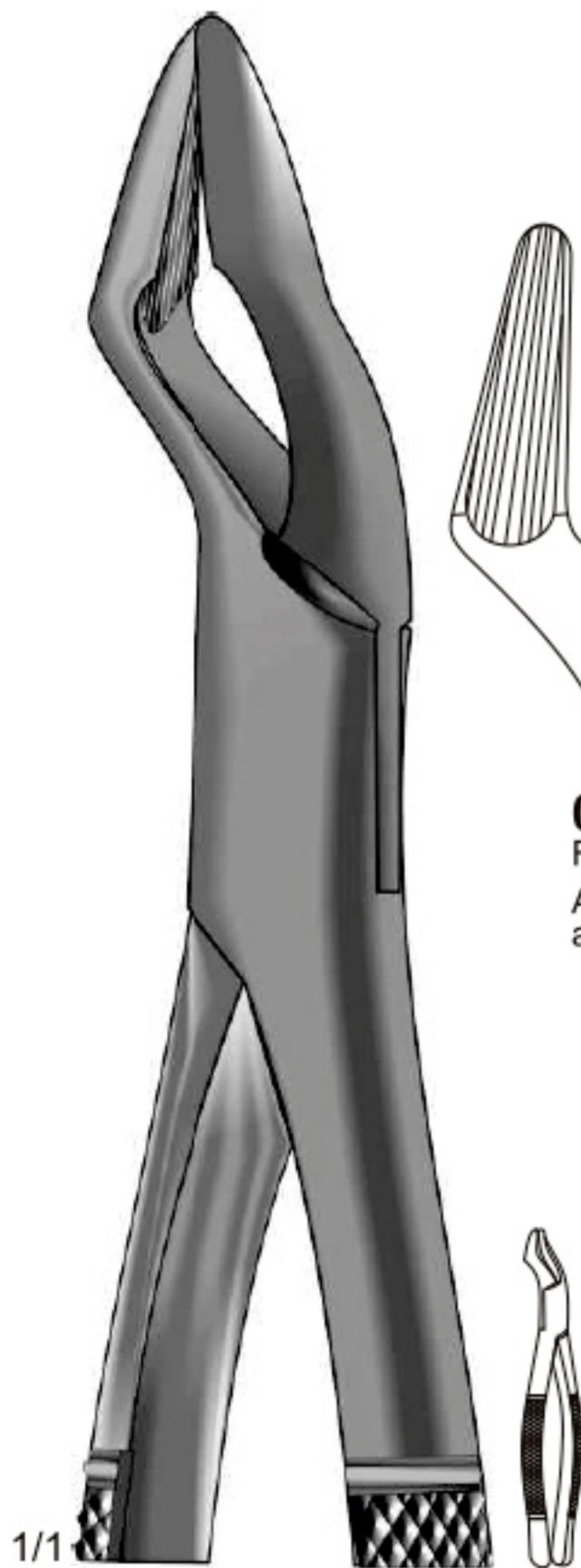

Parmly
04-0732 - 04-0832

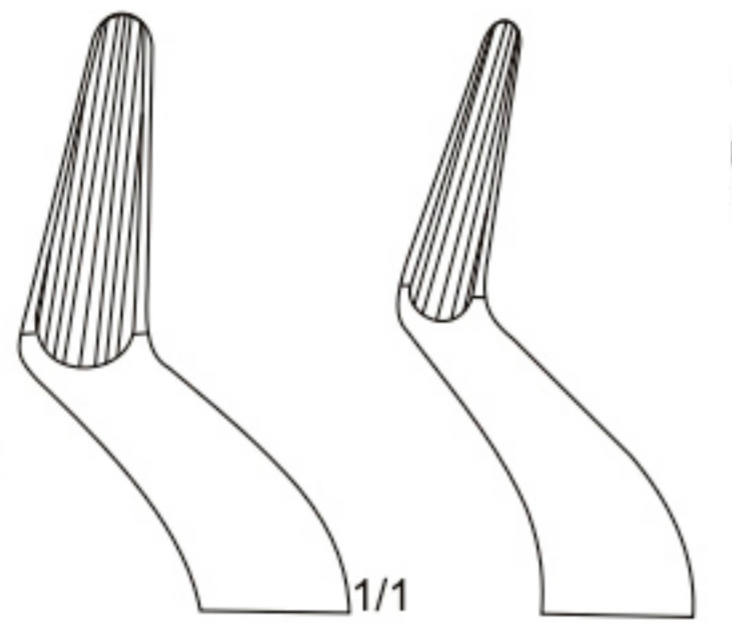

04-0732
Fig. 32
04-0832
Fig. 32 A
Alveolar forceps for upper molars and bicuspid, strong beak



04-0853
Fig. 53 L
For upper molars left side

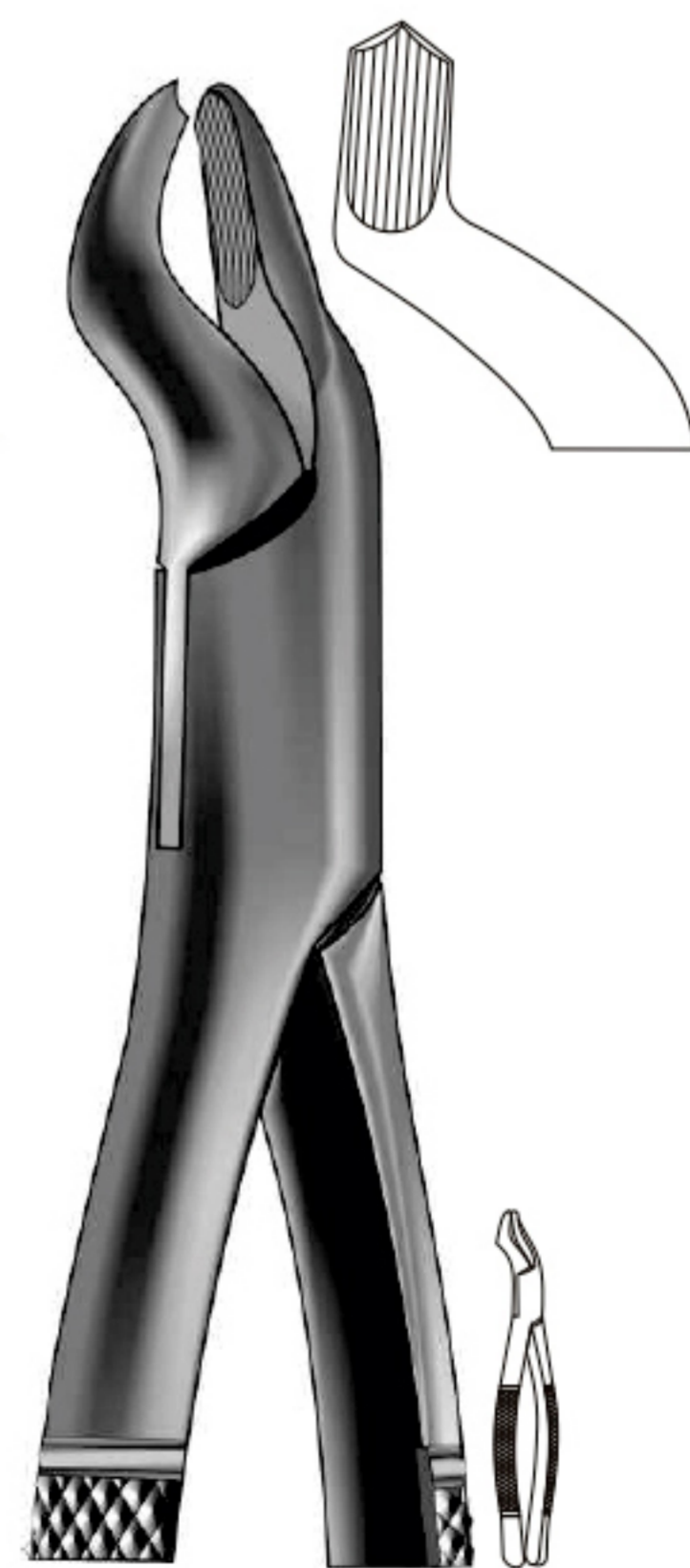

04-0953
Fig. 53 R
For upper molars right side



04-0962
Fig. 62
Universal forceps for upper teeth & roots, also for children

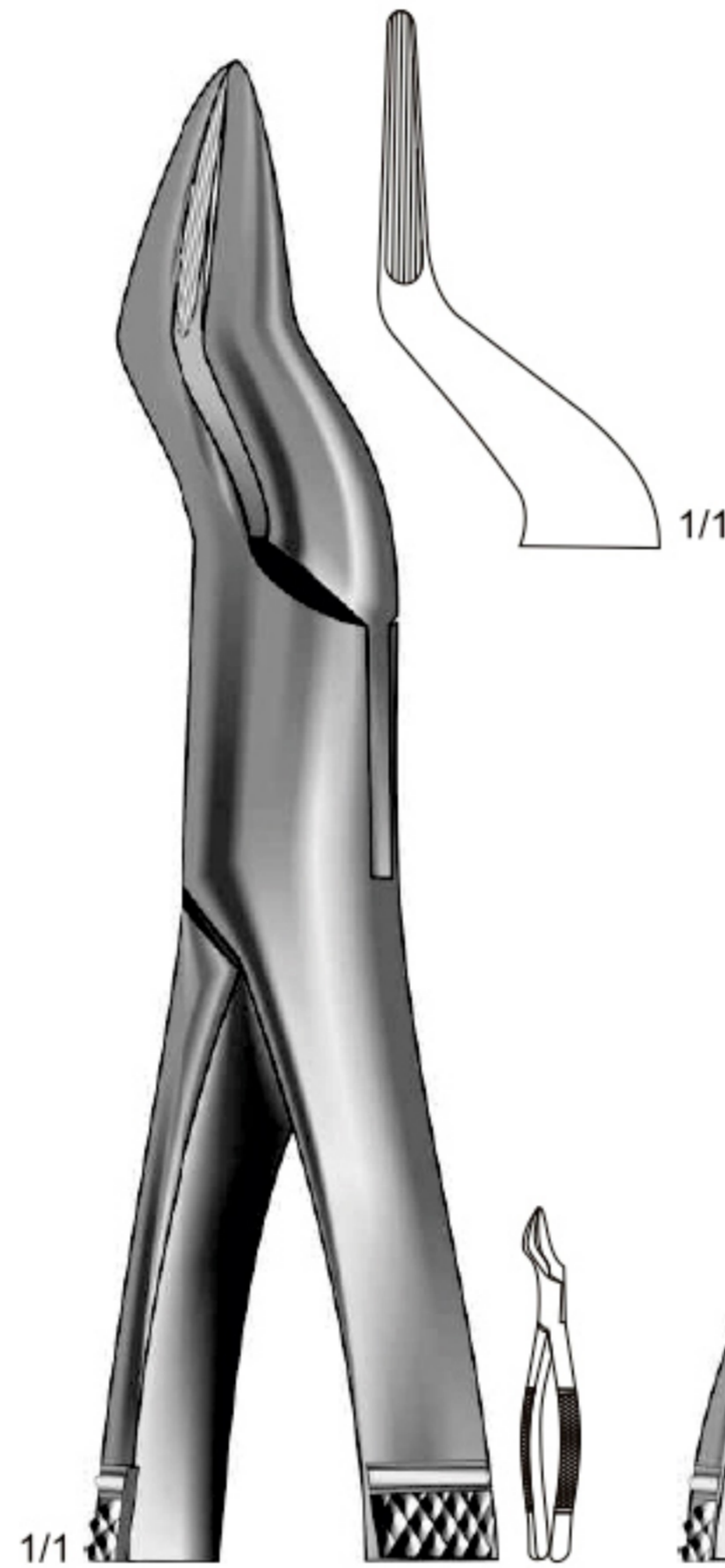

04-0965
Fig. 65
For upper incisors and roots, long slender beak

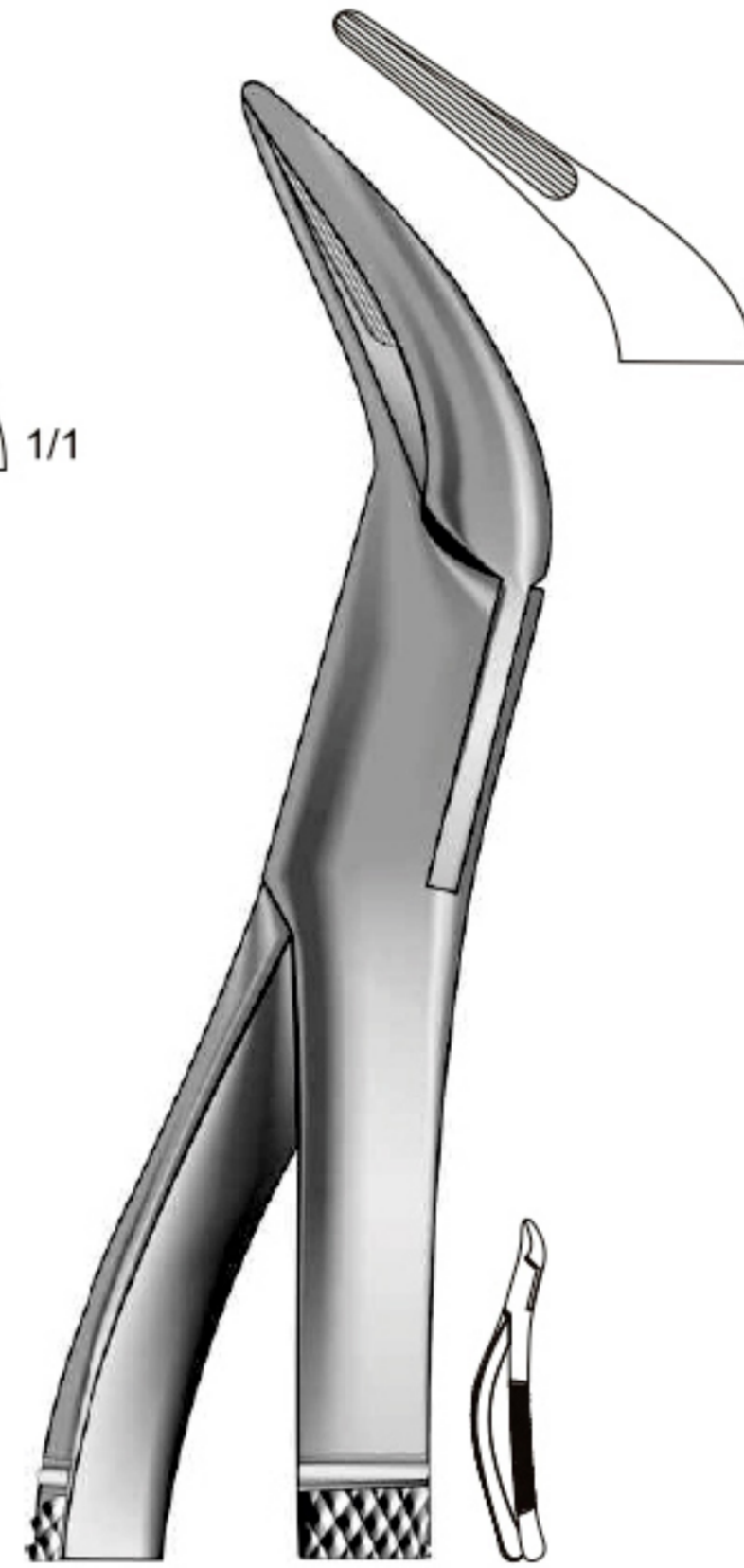

Tomes
04-0969
Fig. 69
For fragments and small roots upper & lower



Hull
04-1101
Fig. .101
Universal forceps for
bicuspid and milk teeth

04-1103
Fig. .103
For lower bicuspid
incisors, roots, either side



Nevius
04-1188
Fig. .88 L
For left upper molar

Nevius
04-1288
Fig. .88 R
For right upper molar



Kells
04-1299
Fig .99 A
For upper bicuspid,
cuspid and incisors



Kells
04-1399
Fig .99 C
For upper bicuspid,
cuspid and incisors



Nevius
04-2110
Fig .110
For upper cuspid and bicuspid



Nevius
04-3110
Fig .110
For upper cuspid and bicuspid



Cryer
04-4150
Fig. 150



Cryer
04-5150
Fig. 150 A



Cryer
04-6150
Fig. 150 S



Cryer
04-6151
Fig. 151



Cryer
04-7151
Fig. 151 A



Cryer
04-8151
Fig. 151 S

- 04-4150 | For Upper Bicuspids, Incisors And Roots
- 04-5150 | For Upper Bicuspids, Incisors And Roots (but Modified)
- 04-6150 | For Upper Bicuspids, Incisors And Roots
- 04-6151 | For Lower Bicuspids, Incisors And Roots
- 04-7151 | For Lower Bicuspids, Incisors And Roots
- 04-8151 | For Lower Bicuspids, Incisors And Roots

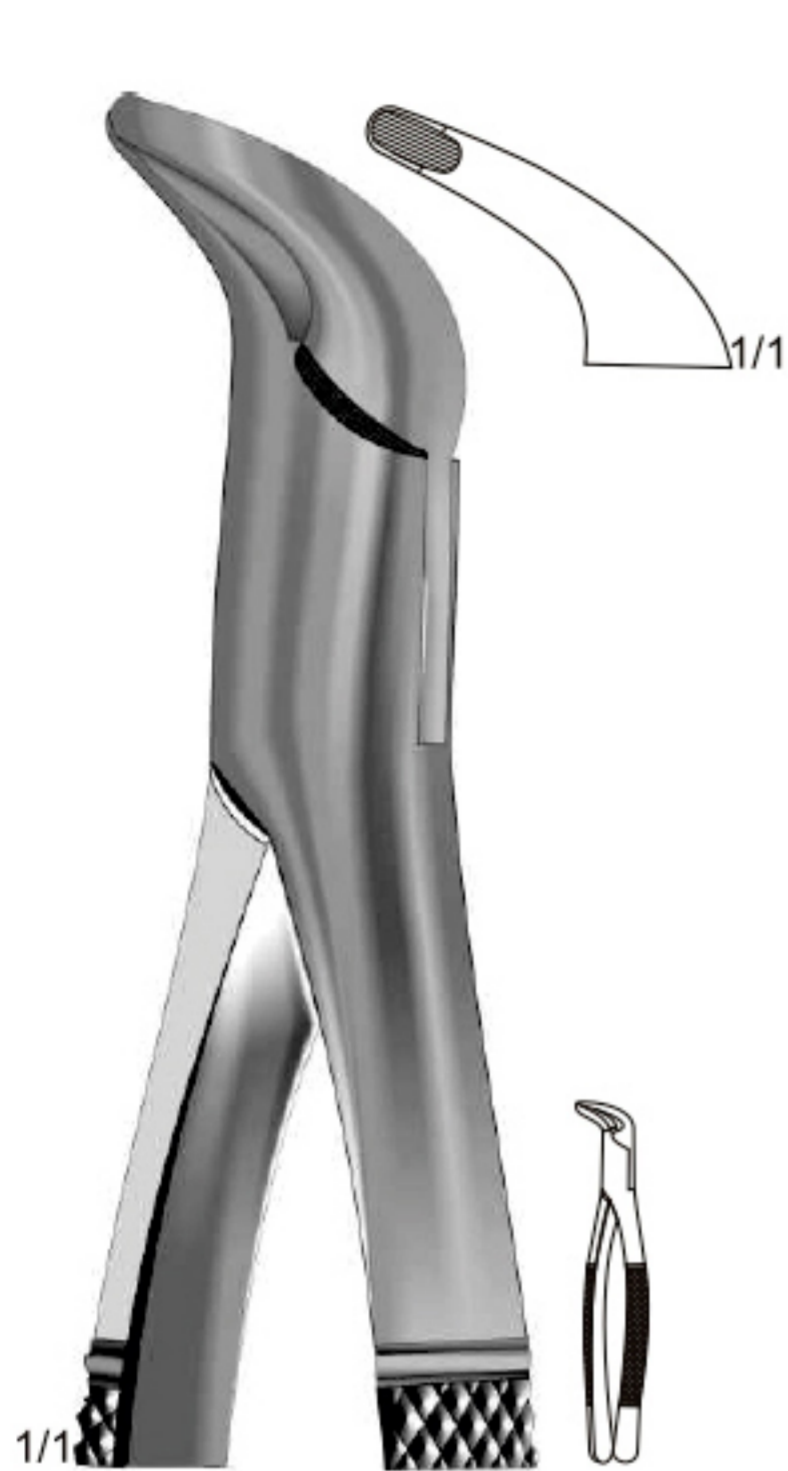

04-8203
Fig. 203

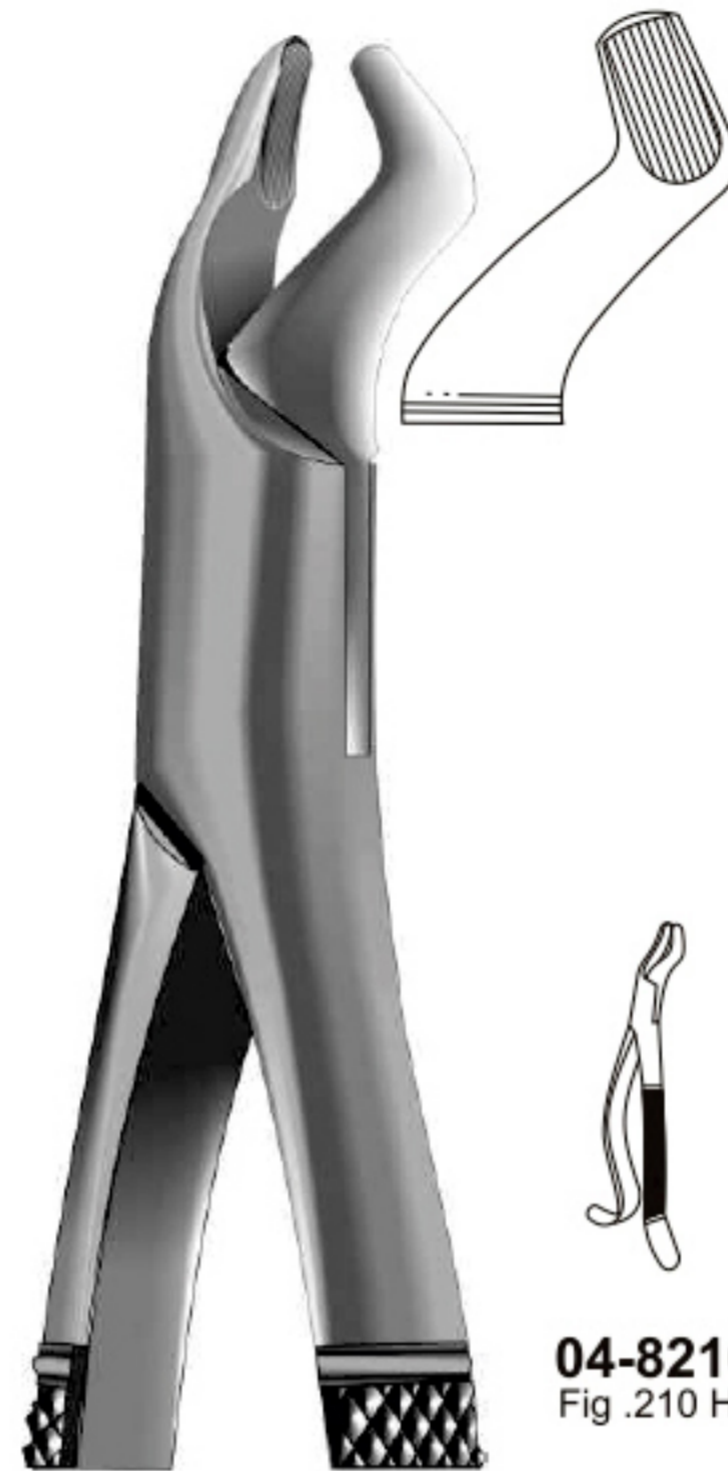

04-8210 - 04-9210

04-8210
Fig .210 H

04-9210
Fig .210 S



04-9217
Fig .217

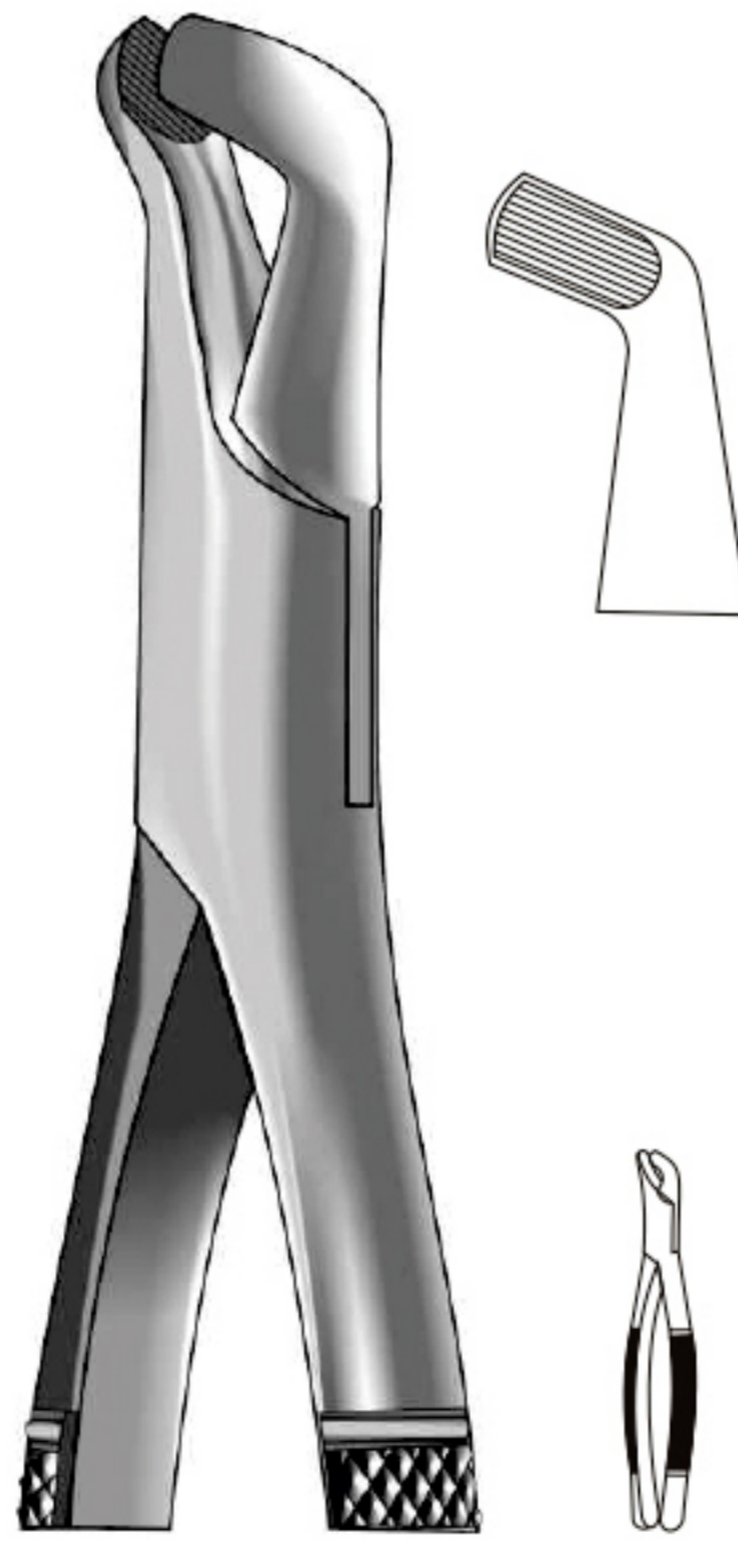

04-9222
Fig .222

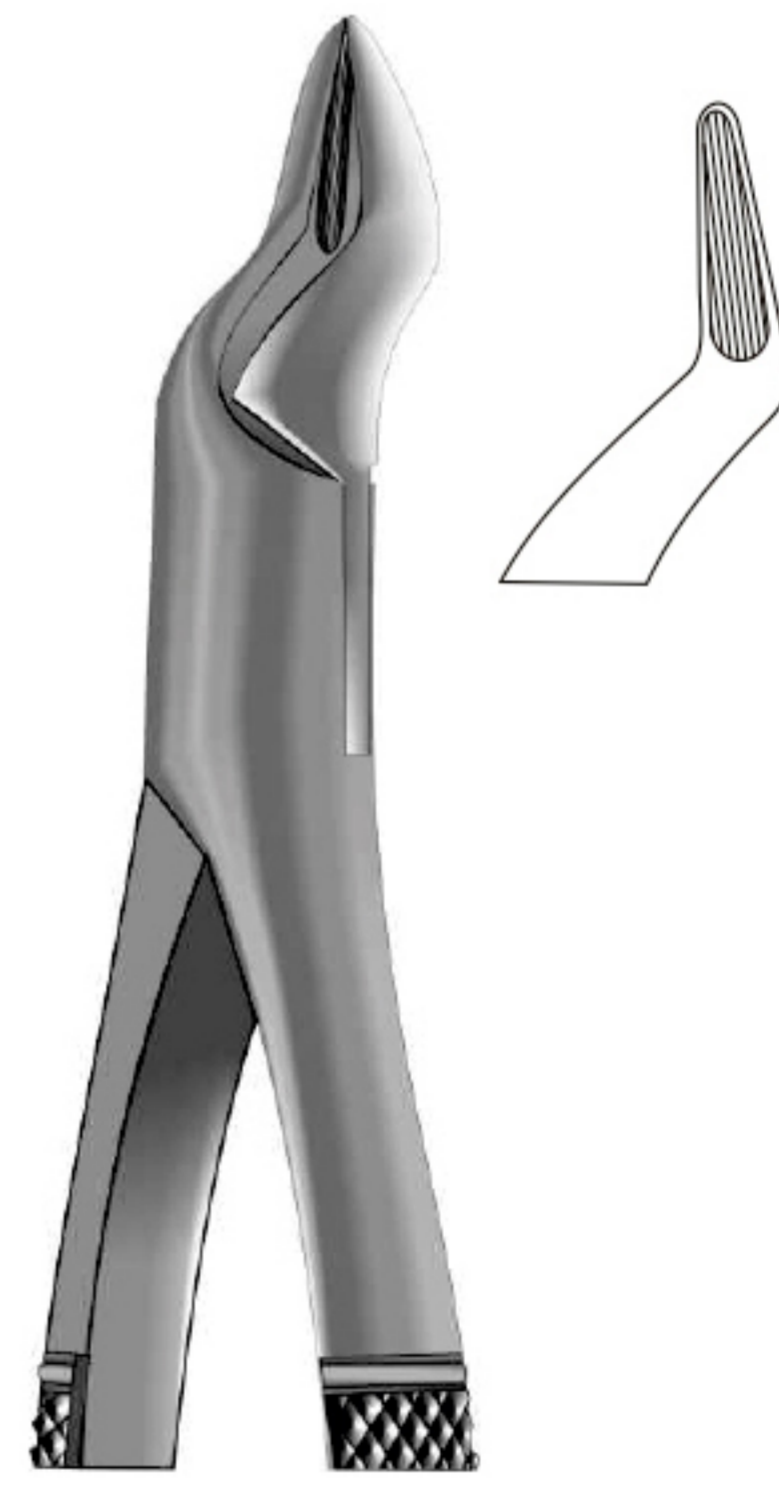

04-9286
Fig .286

- 04-8203 For lower bicuspid, incisors and roots, either side
- 04-8210 For upper wisdoms, either side
- 04-9210 For upper wisdoms, either side
- 04-9217 For lower molars, either side
- 04-9222 For lower wisdoms, either side
- 04-9286 For upper roots, bicuspid and incisors, either side

CH 05

Root Elevators



Choice of Handles for Root Elevators.

If you wish to order a different type (**A, B, C, D, E, F and G**) of handle for a particular product, please mention **that** type with the code number of that product.

Example : 05-0701E

If you wish to order a particular type (**A, B, C, D, E, F and G**) of handle with all instruments, please mention **that** type in your purchase order.

Example : Please use handle C for all Scalers.



A

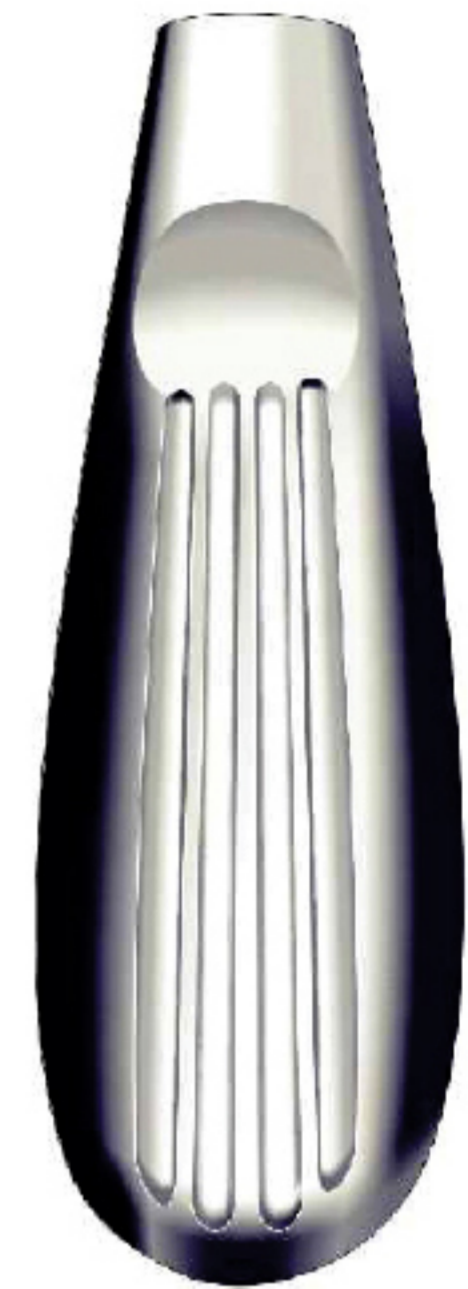

B



C



D



E

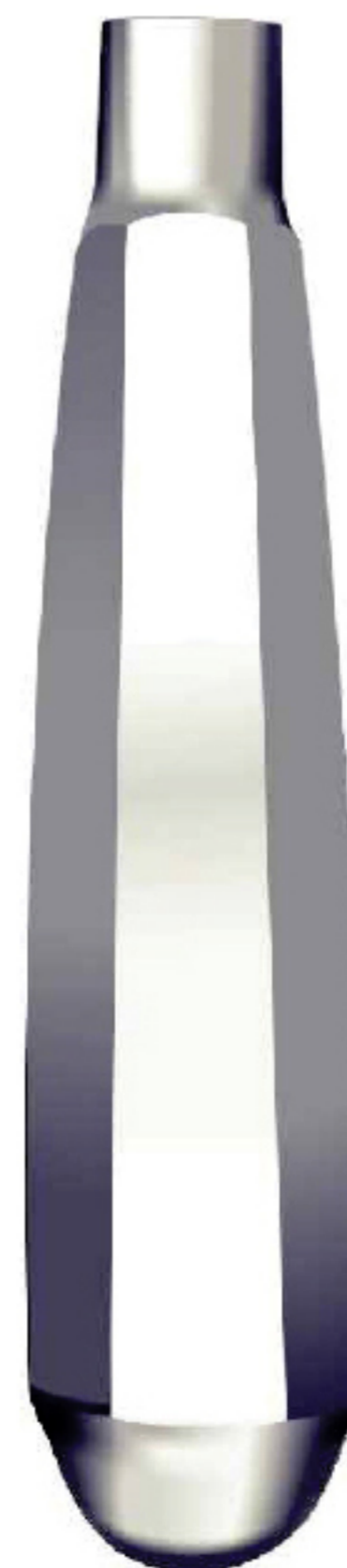

F



G

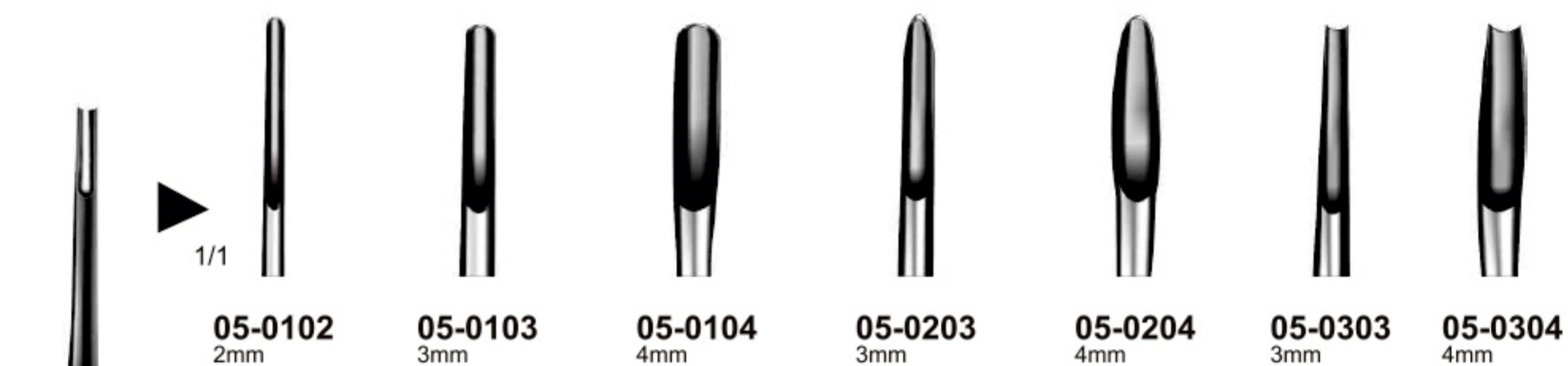

Bein
05-0102 - 05-0304
13.5 cm/ 5 1/4"

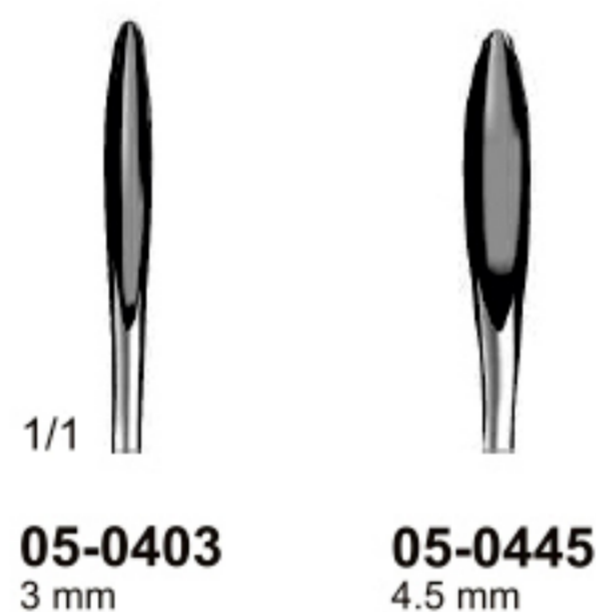

Hylin
05-0403 - 05-0603
14 cm/ 5 1/2"



Hylin
05-0403 - 05-0603
14 cm/ 5 1/2"

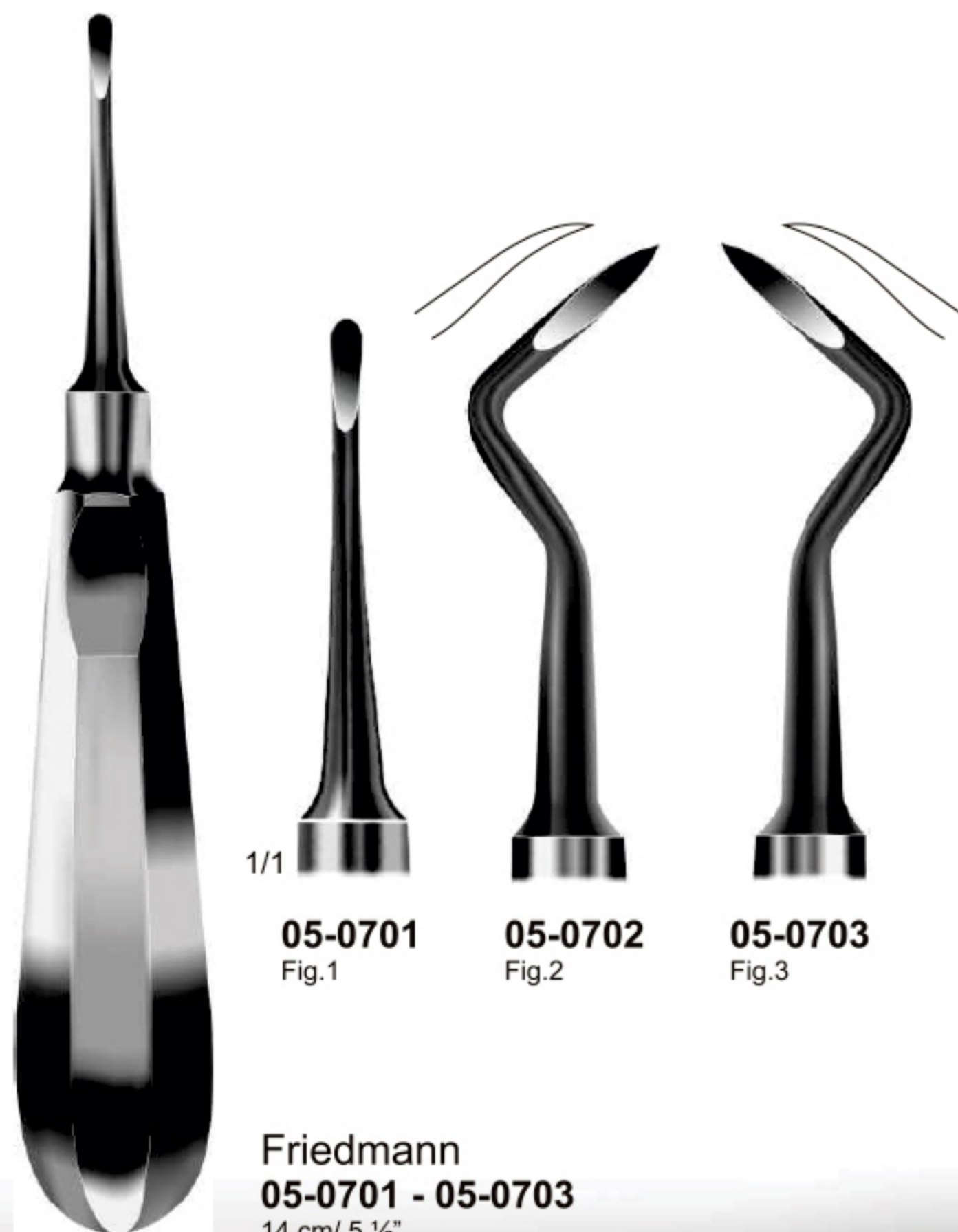

Friedmann
05-0701 - 05-0703
14 cm/ 5 1/2"

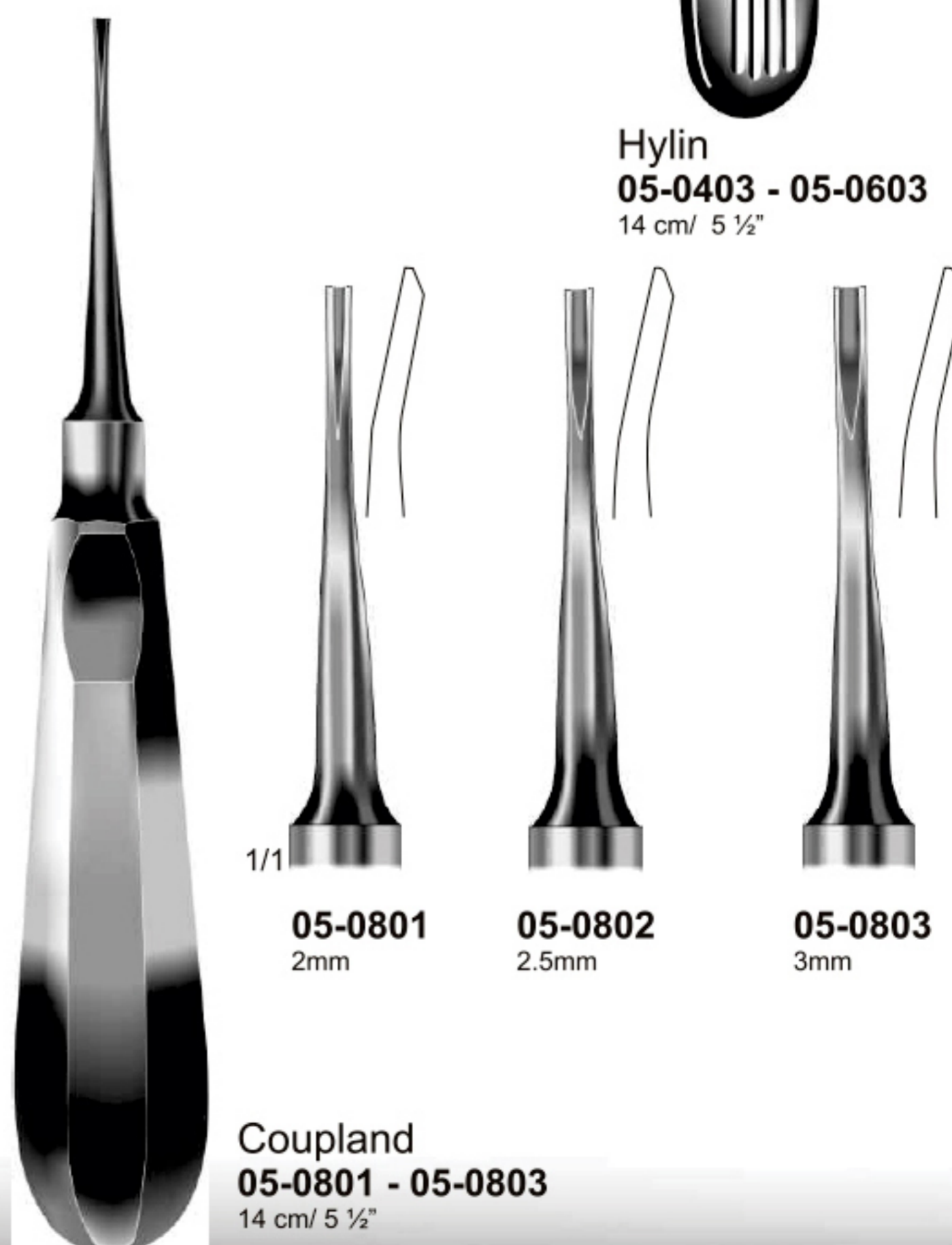

Coupland
05-0801 - 05-0803
14 cm/ 5 1/2"

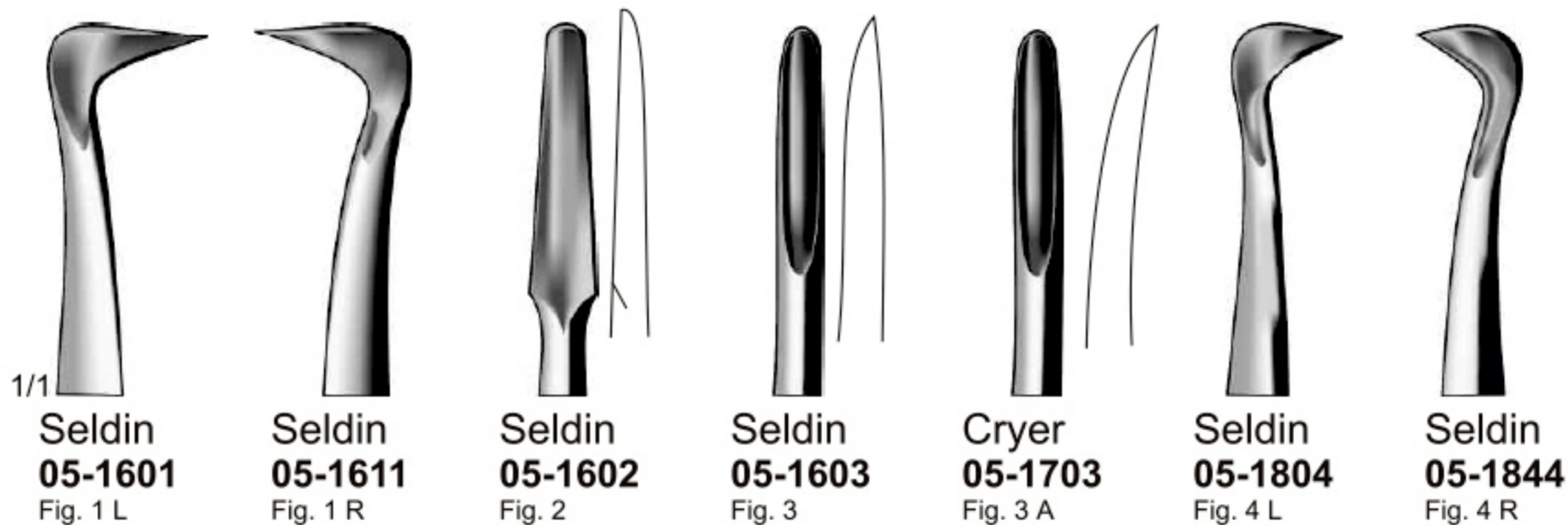
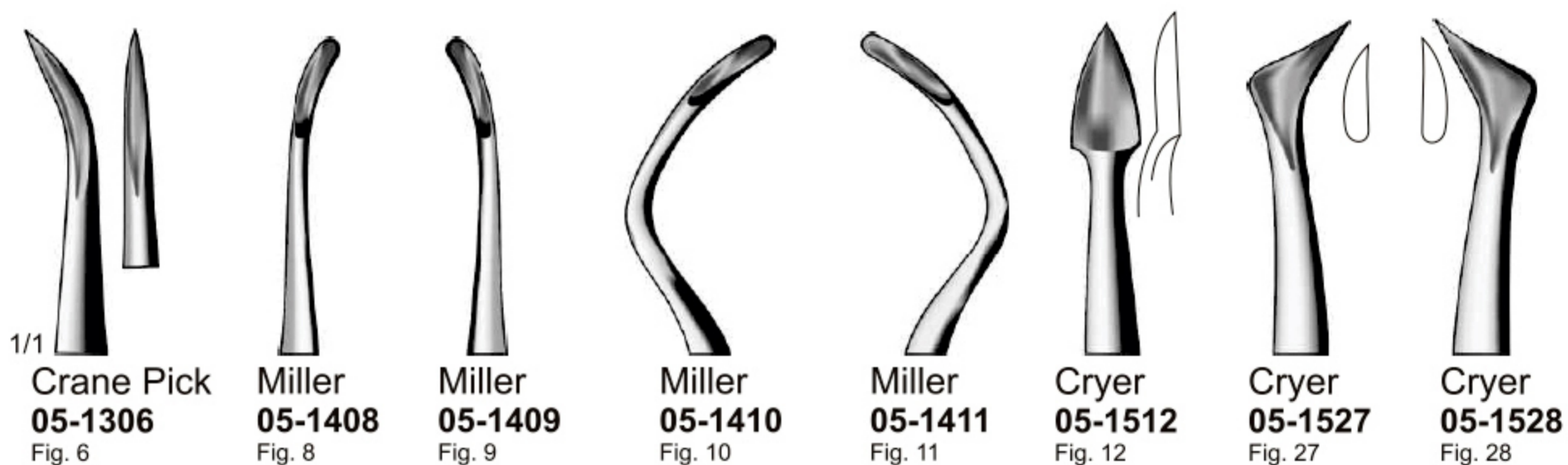
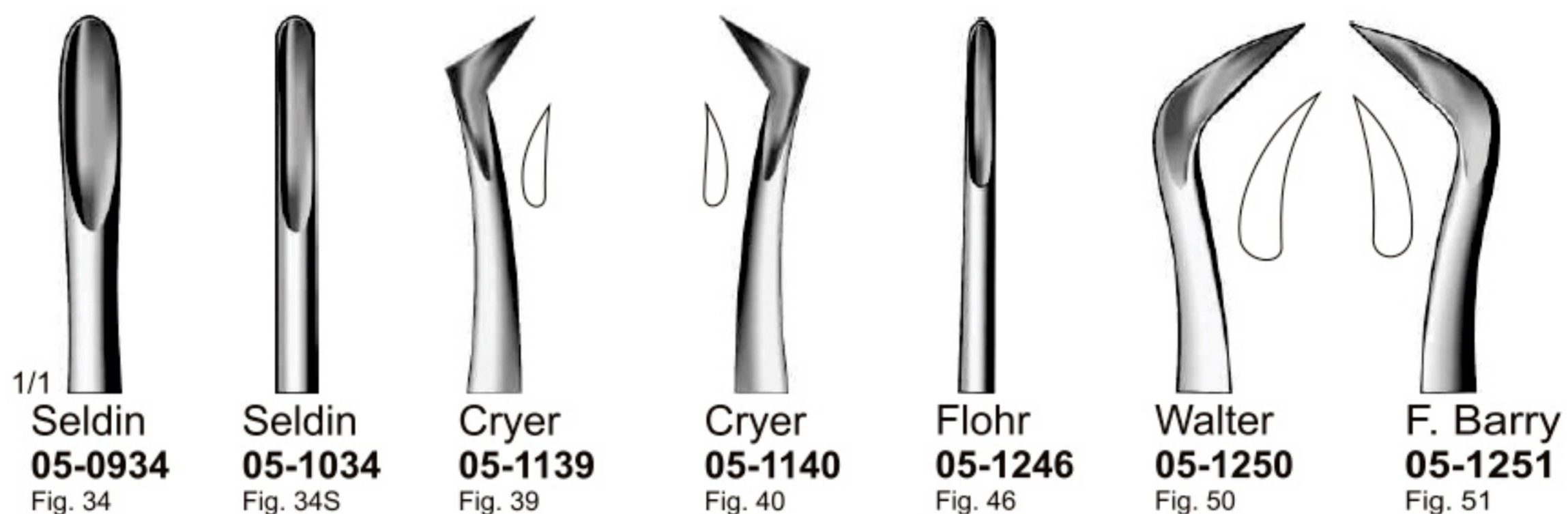

05-0934 - 05-2304
 13.5 cm/ 5 1/4"

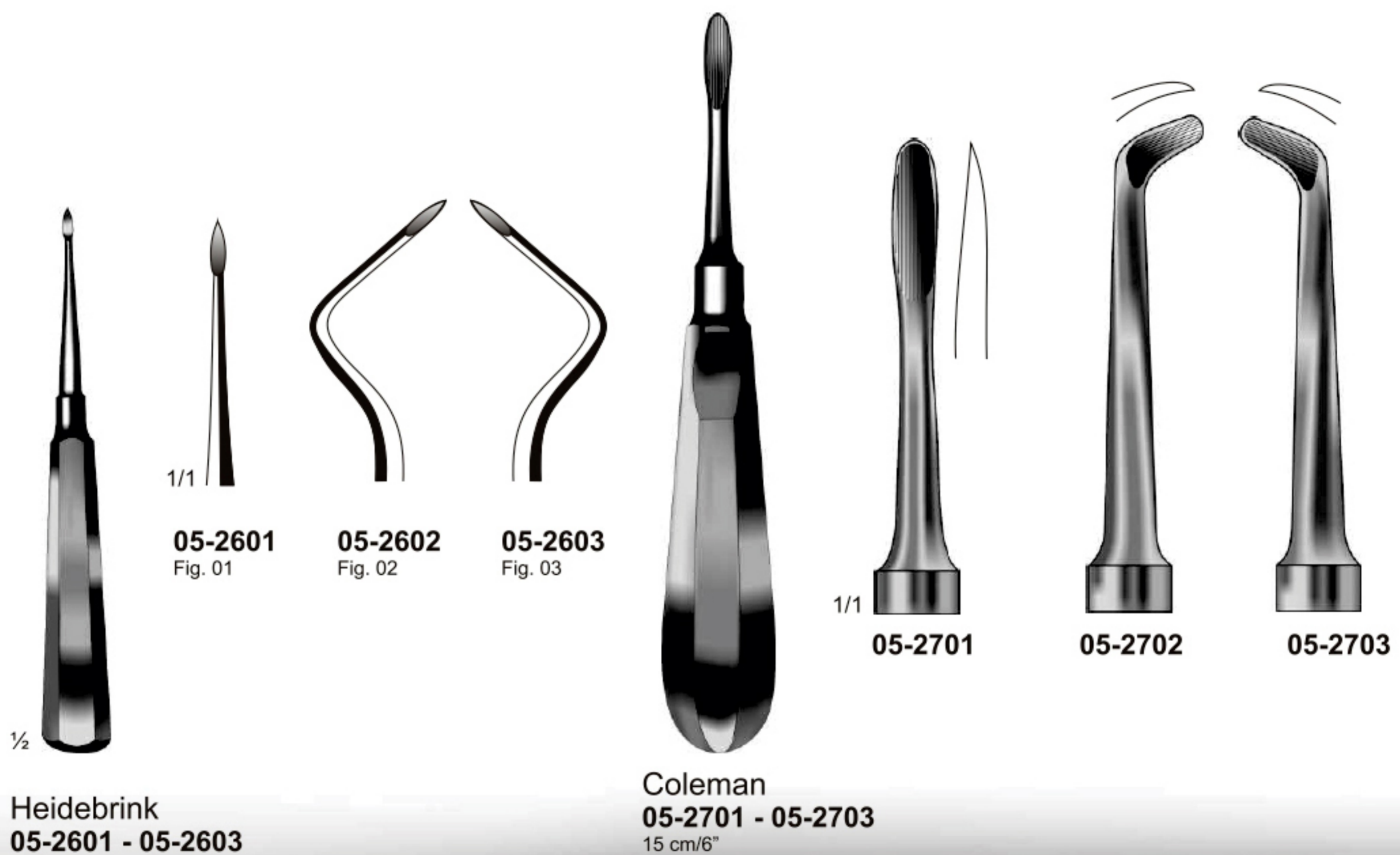
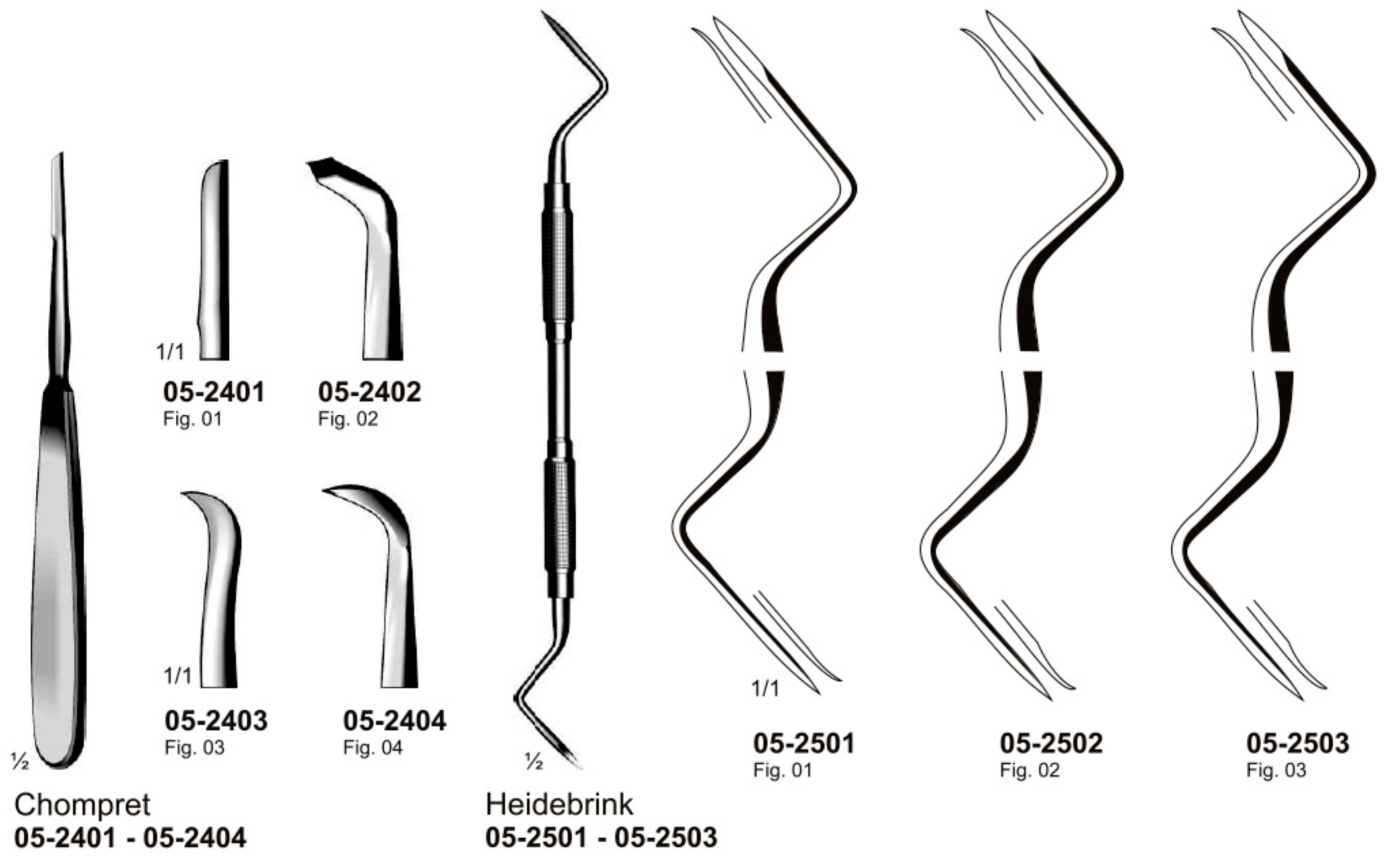

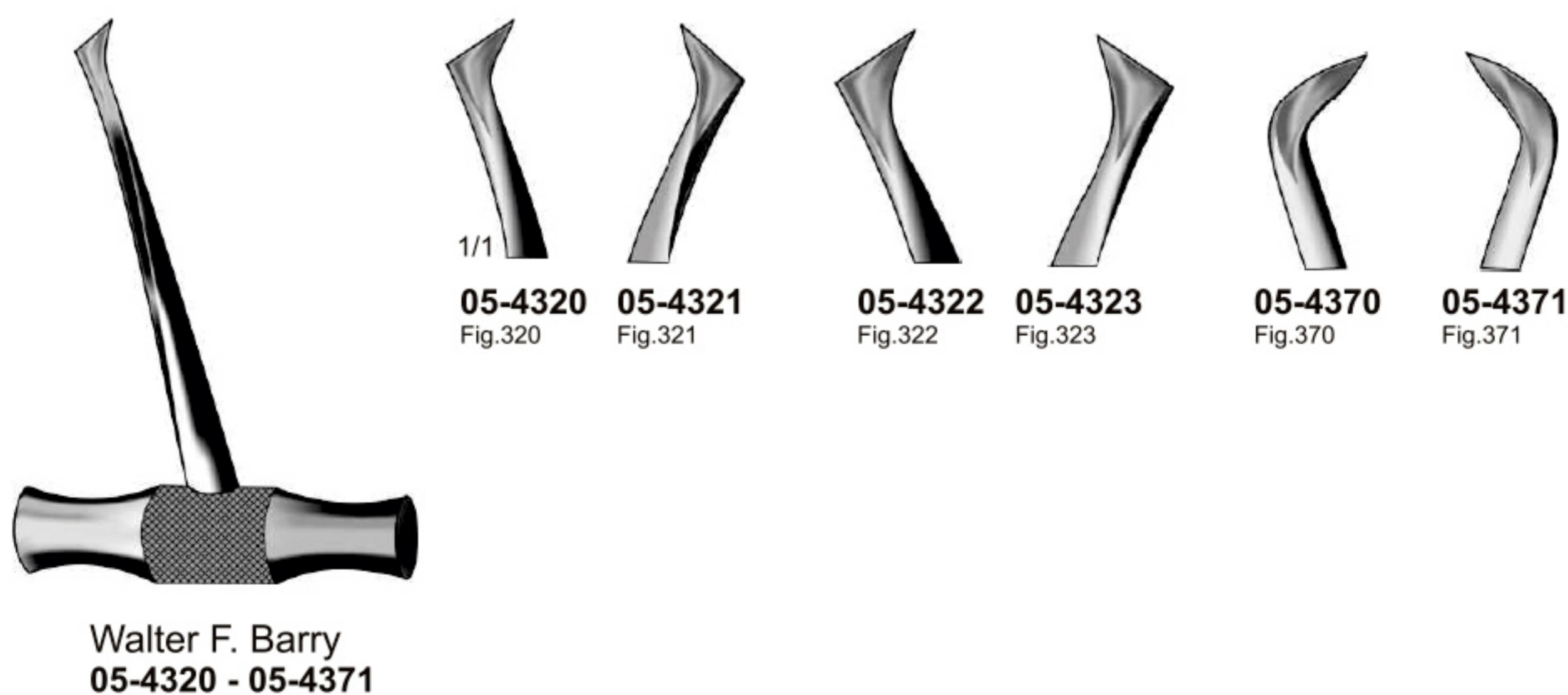
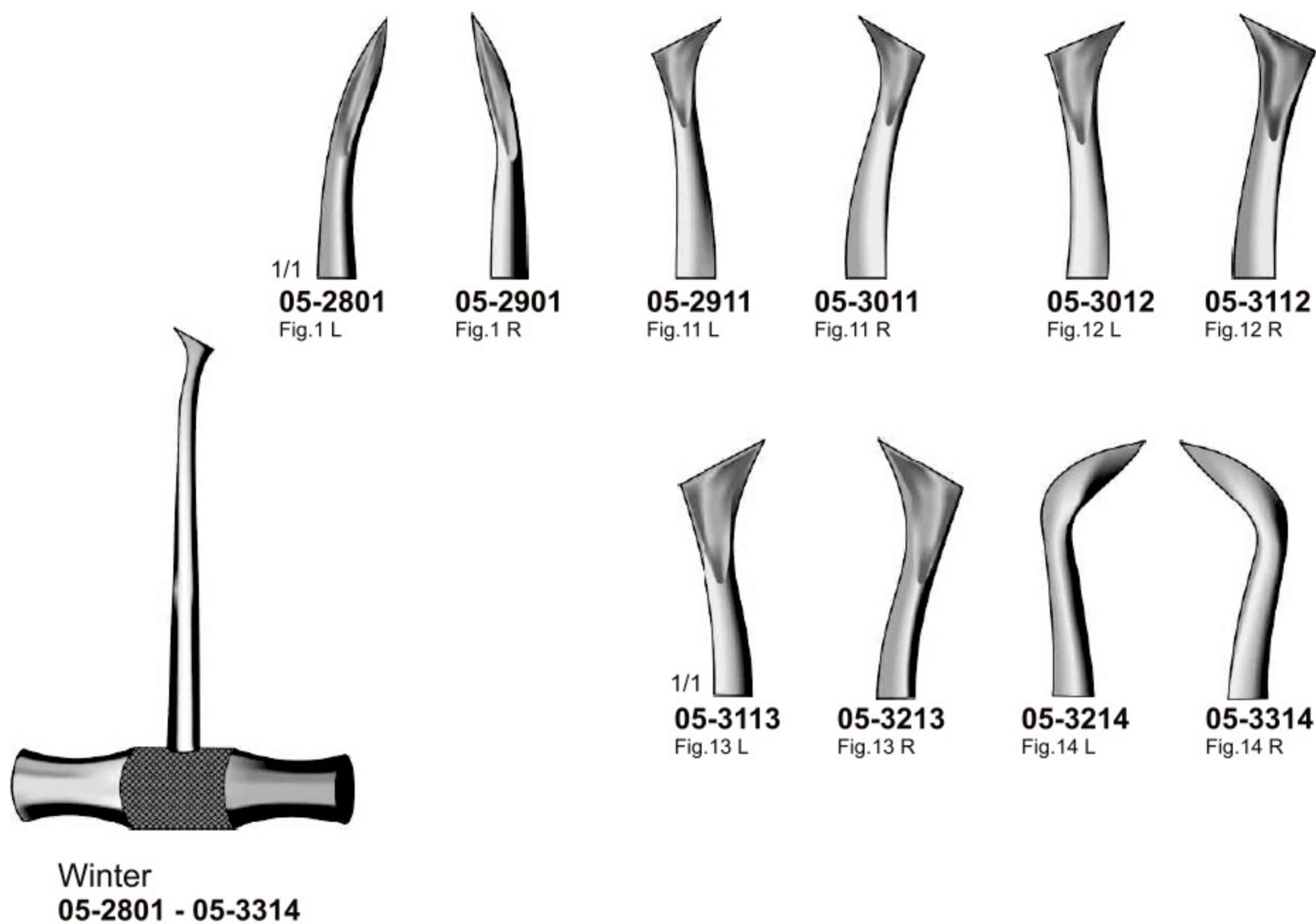



Krallengnber
05-4401



Krallengnber
05-4402



Lecluse
05-4501



Pott
05-4601 - 05-4602



West
05-4723
Fig 2/3

West
05-4756
Fig. 5/6

Warwick-James
05-4801
16 cm/ 6 1/4"

Warwick-James
05-4802
16 cm/ 6 1/4"

Warwick-James
05-4803
16 cm/ 6 1/4"

Walter F. Barry
05-4904 - 05-4906

CH 06

Amalgam Instruments
Amalgaminstrumente
Instrumentos para amalgama
Instrumentos à amalgame
Strumenti per amalgma



Choice of Handles for Scalers, Amalgam Instruments, Filling Instruments, Curettes, Probes, Knives, Explorers and Excavators

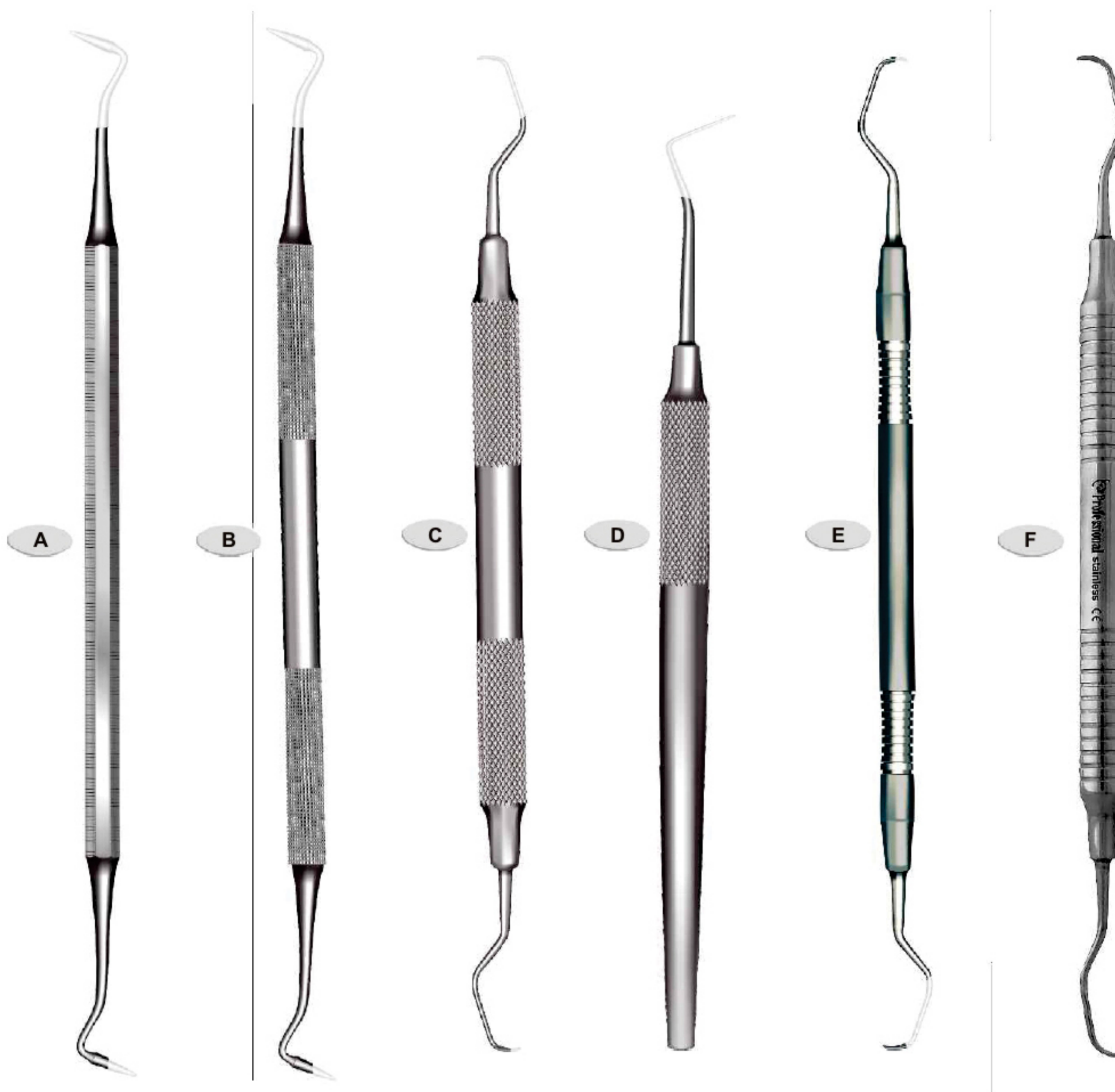

If you wish to order a different type (A, B, C, D, E and F) of handle for a particular products, please mention that type with the code number of that product.

Example : 06-1001C

If you wish to order a particular type (A, B, C, D, E and F) of handle with all instruments, please mention that type in your purchase order.

Example : Please use handle C for all Scalers.

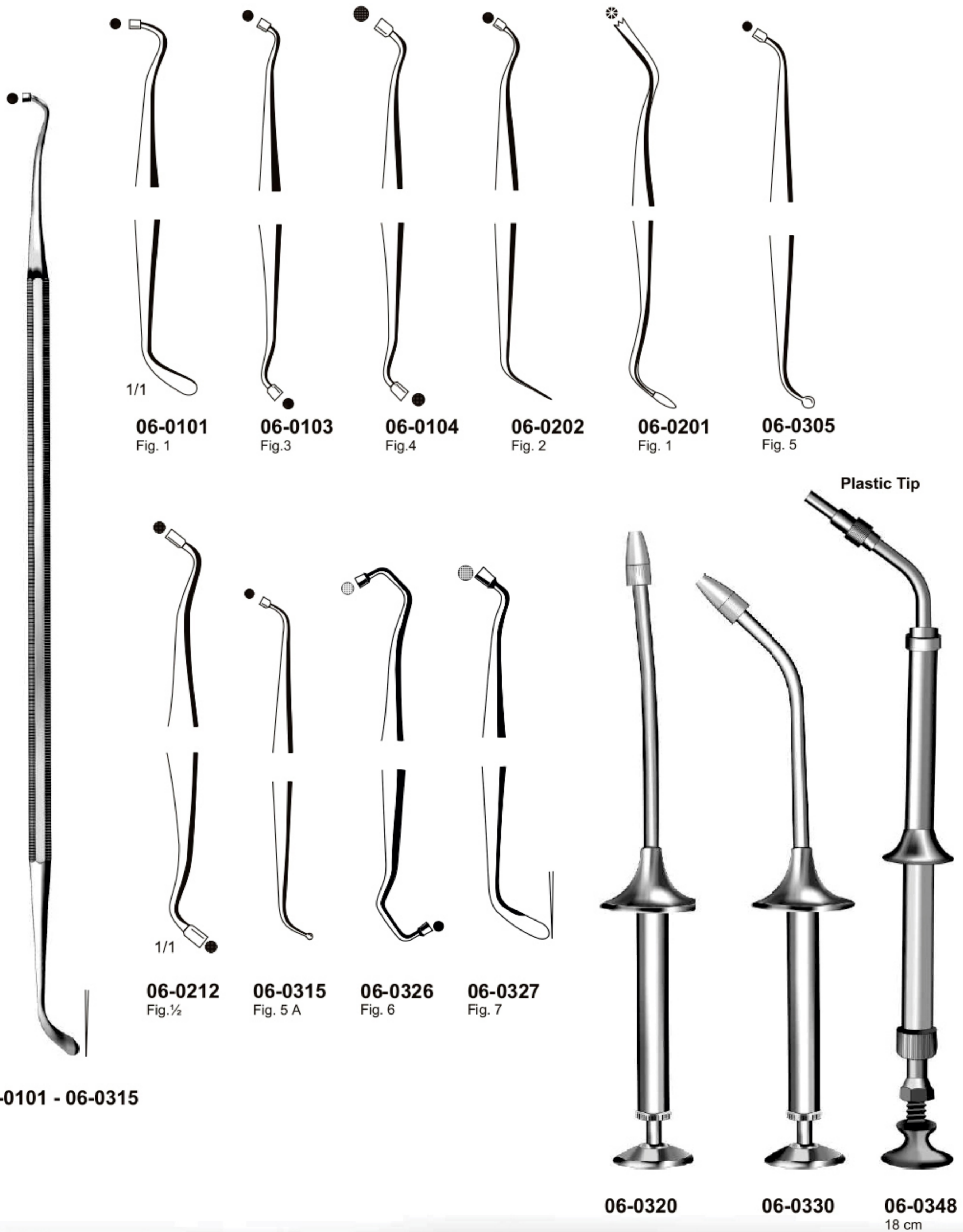

06-0101 - 06-0315

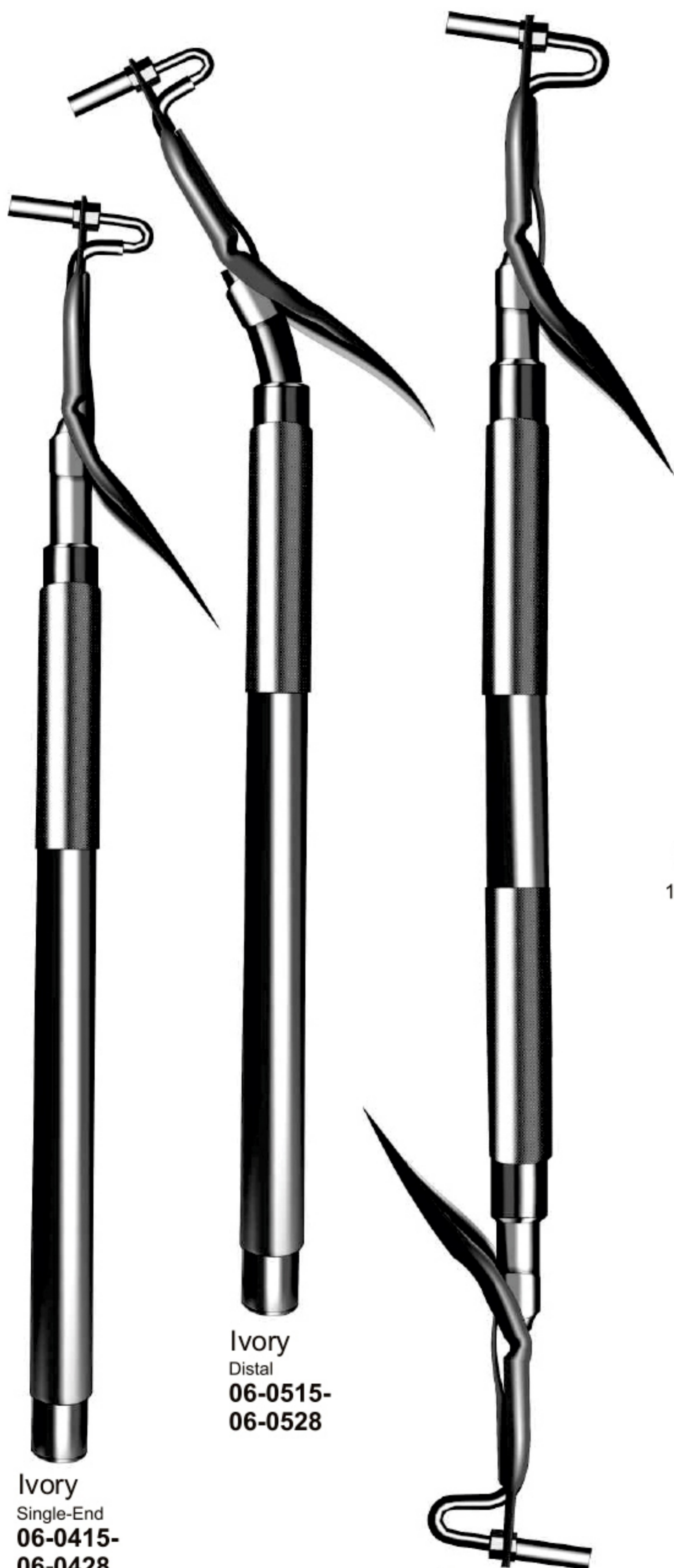

Ivory
Single-End
06-0415-
06-0428

Ivory
Distal
06-0515-
06-0528

Ivory
Double-End
06-0615-
06-0632

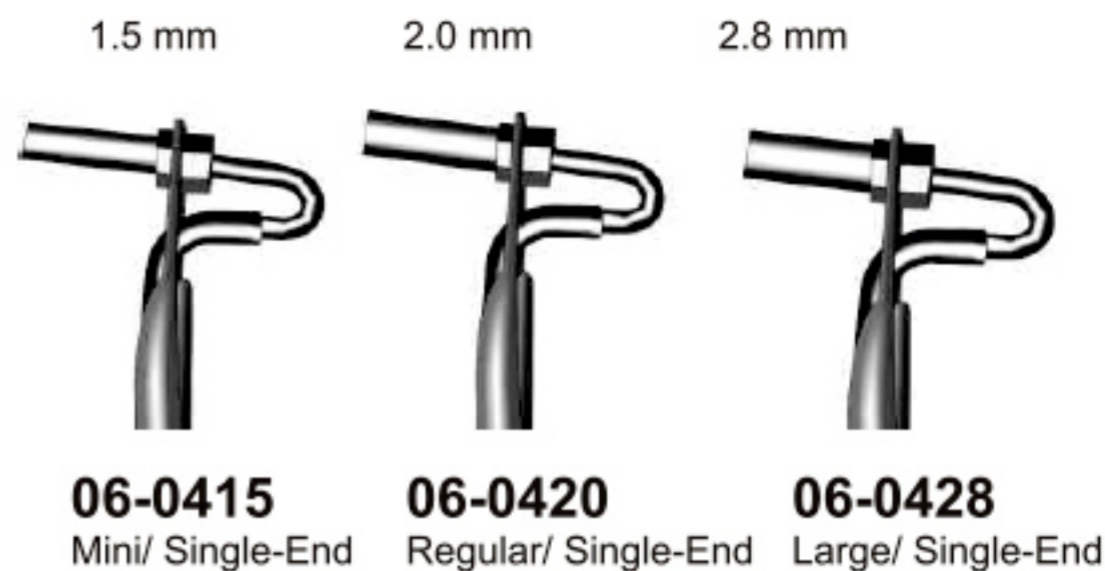

06-0415 Mini/ Single-End
06-0420 Regular/ Single-End
06-0428 Large/ Single-End

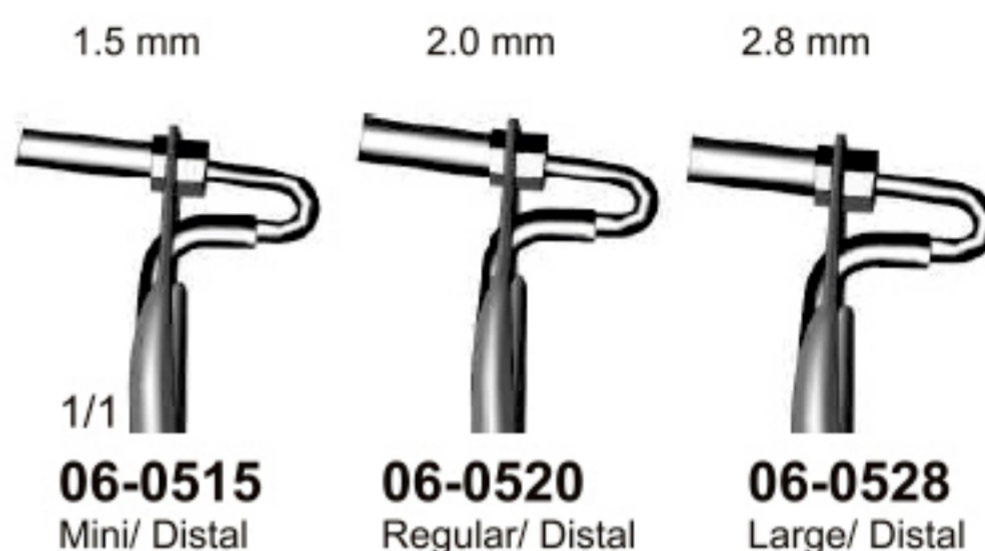

06-0515 Mini/ Distal
06-0520 Regular/ Distal
06-0528 Large/ Distal

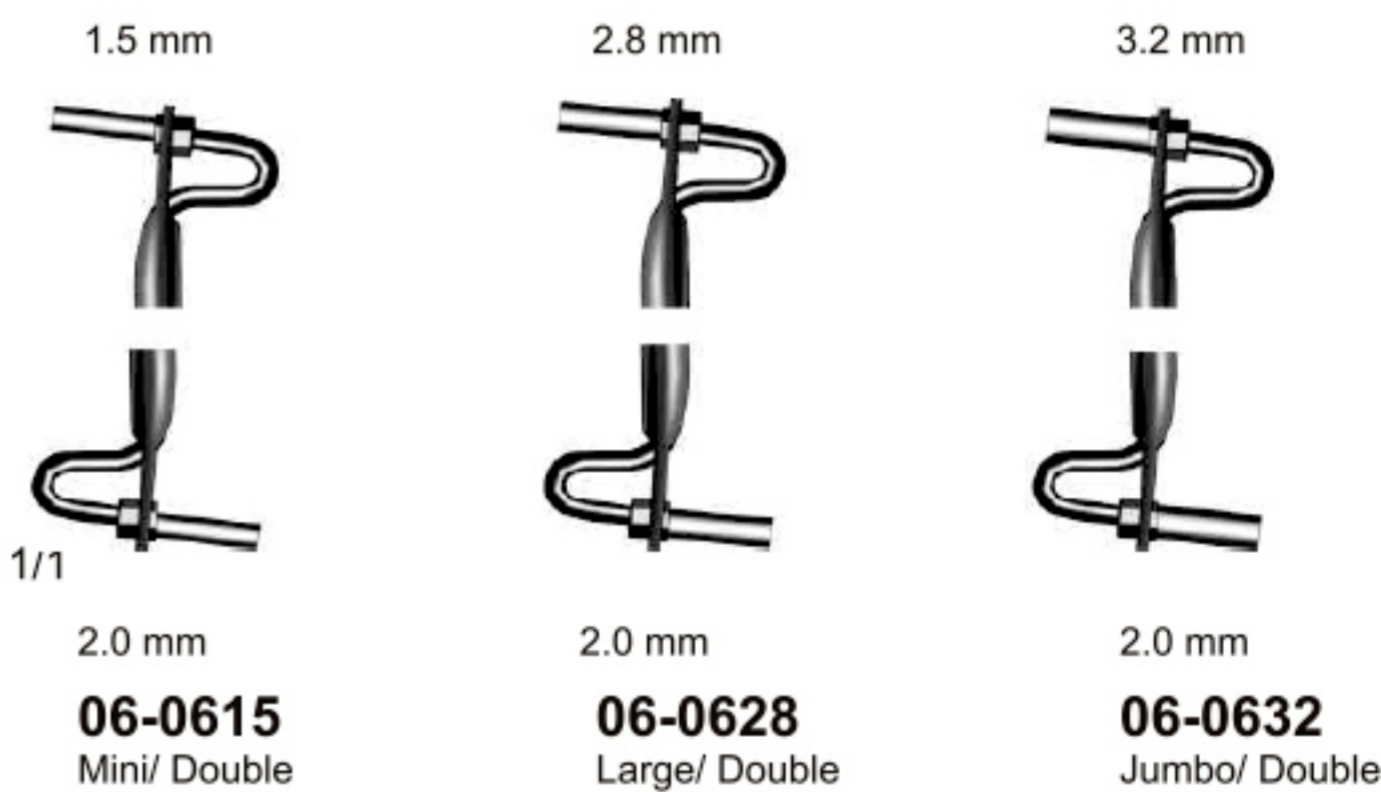

06-0615 Mini/ Double
06-0628 Large/ Double
06-0632 Jumbo/ Double



06-0730
Ø 30 mm



Amalgam well
06-0935
3,5 cm Ø
3,5 cm h.



06-0830
Ø 30 mm

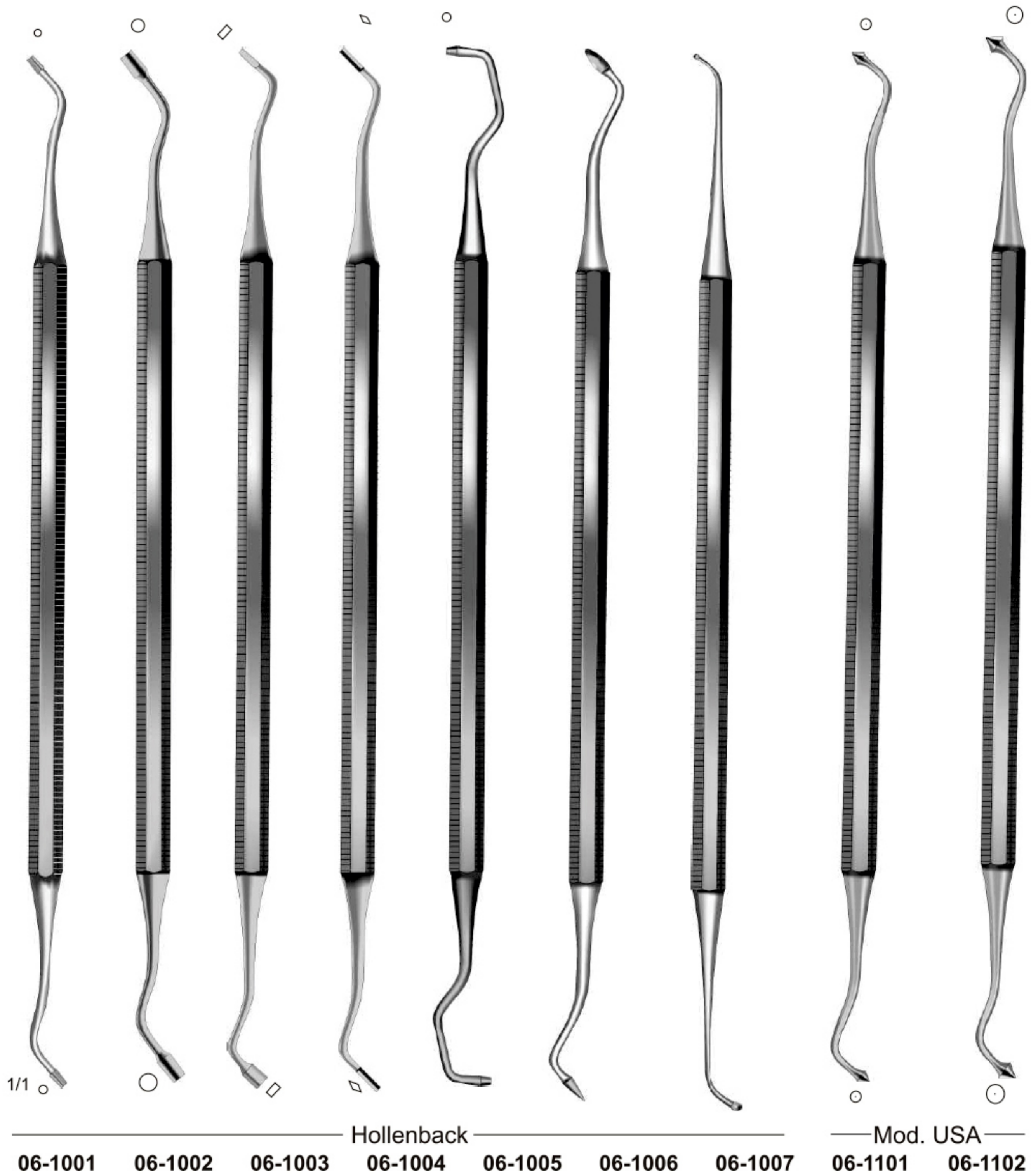

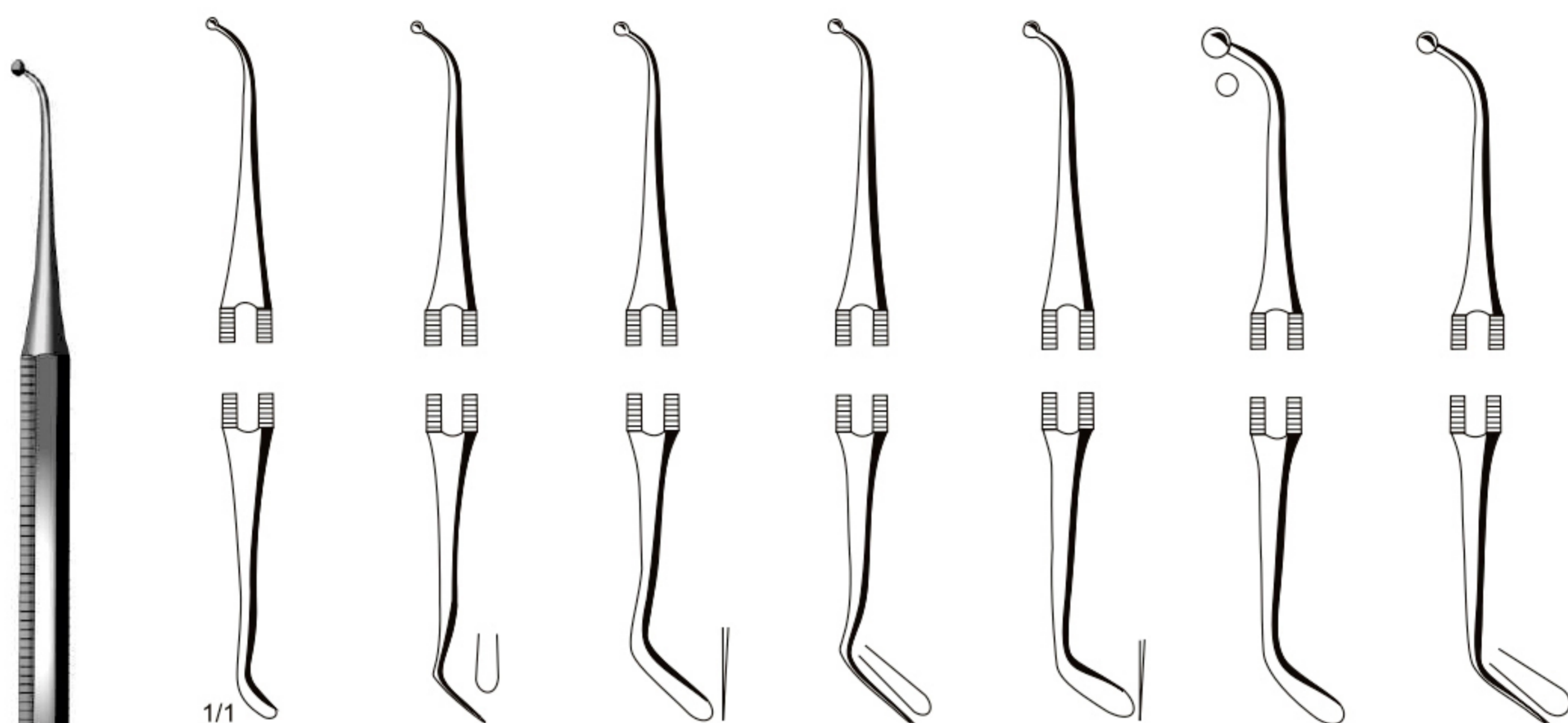

1/1

Mod. PHF

06-1201
Fig.1

06-1202
Fig.2

06-1303
Fig.3

06-1403
Fig.3 A

06-1404
Fig.4

06-1504
Fig.4 A

06-1544
Fig.4 R

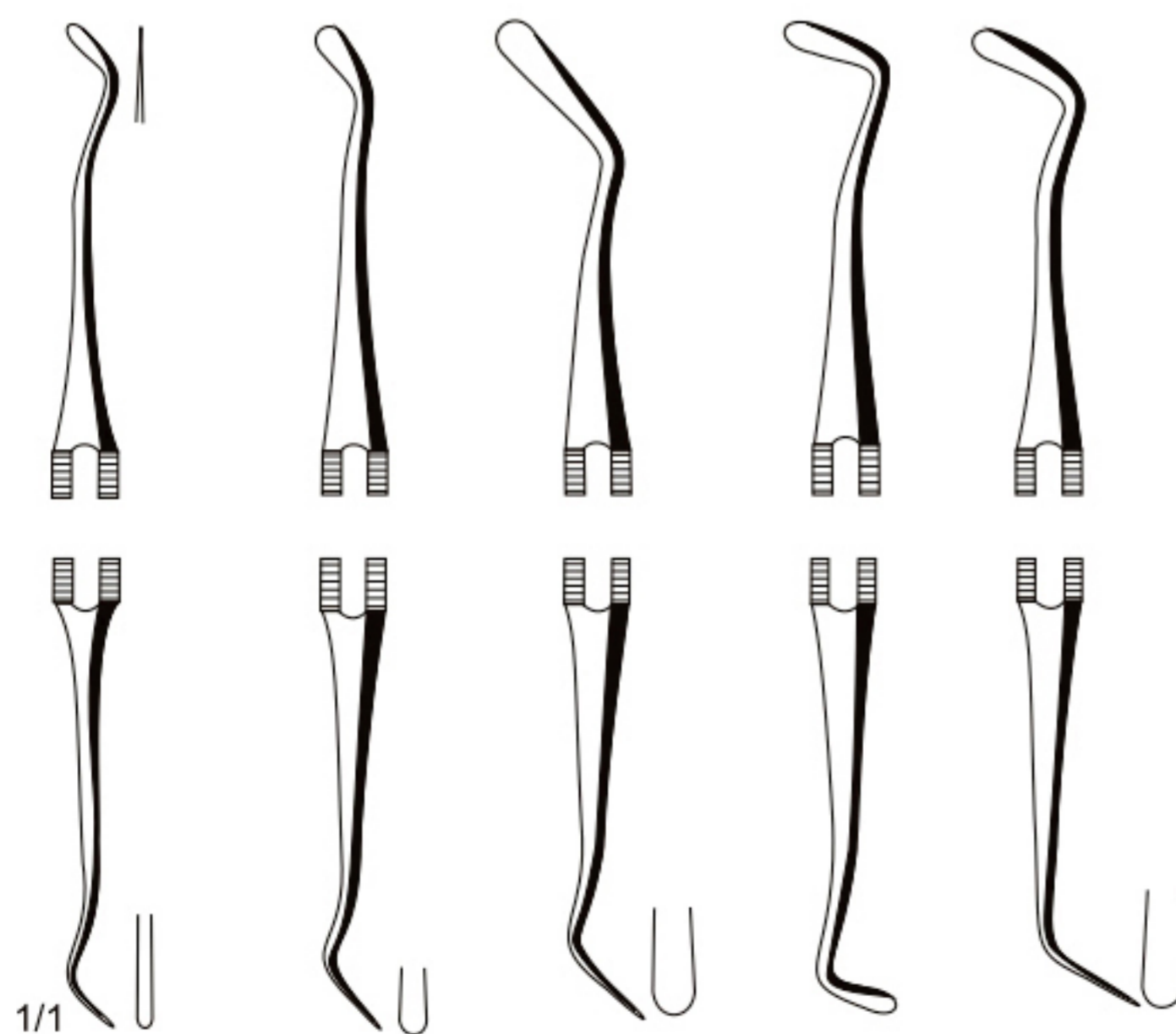

1/1

06-1600
Fig.0

06-1601
Fig.1

06-1602
Fig.2

06-1604
Fig.4

06-1606
Fig.6

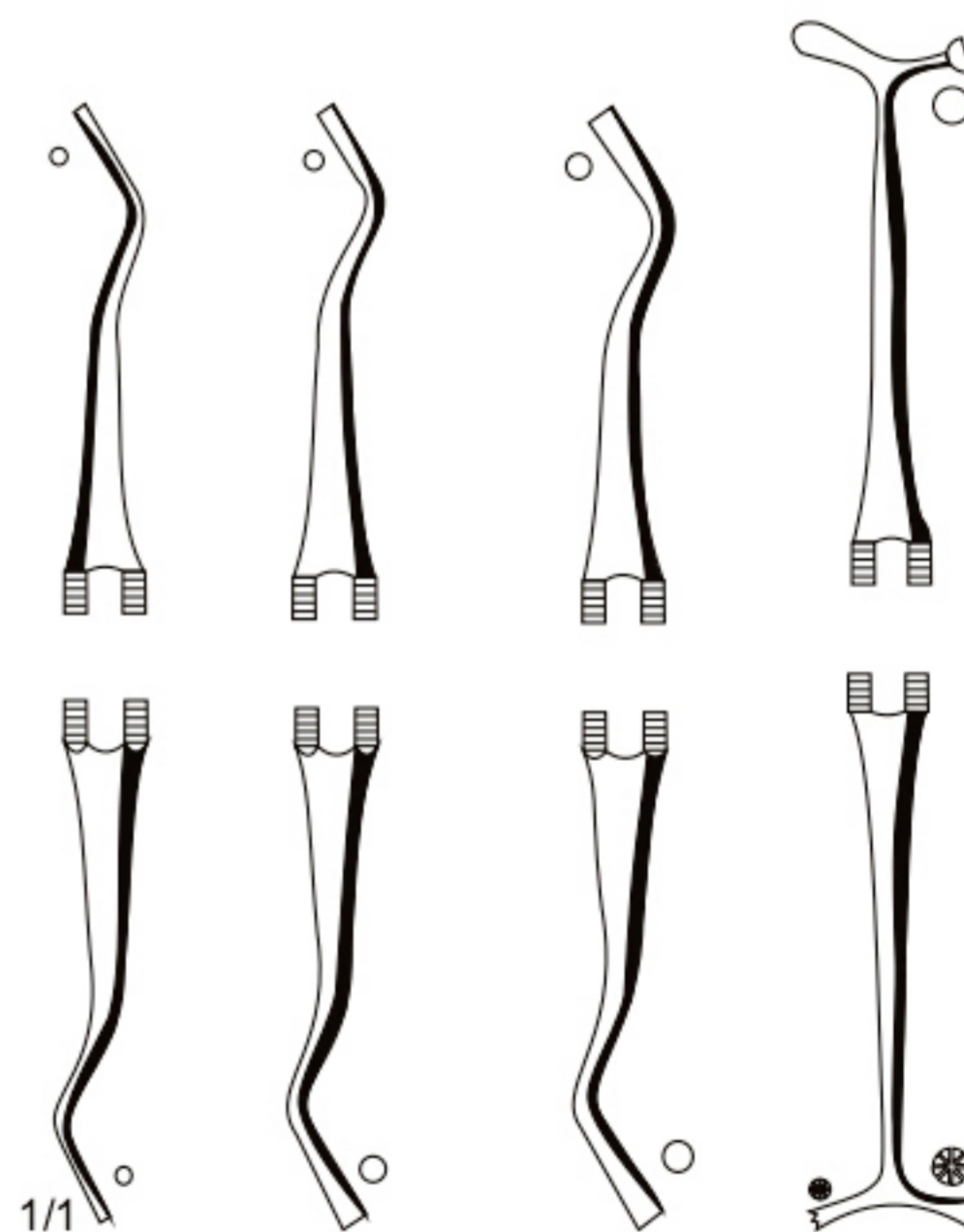

1/1

Williams

06-1700
Fig.0

06-1701
Fig.1

06-1702
Fig.2

06-1703
Fig.3

**06-1201 -
06-1544**
16cm/6 1/4"

Please see page 34 for different handle styles.

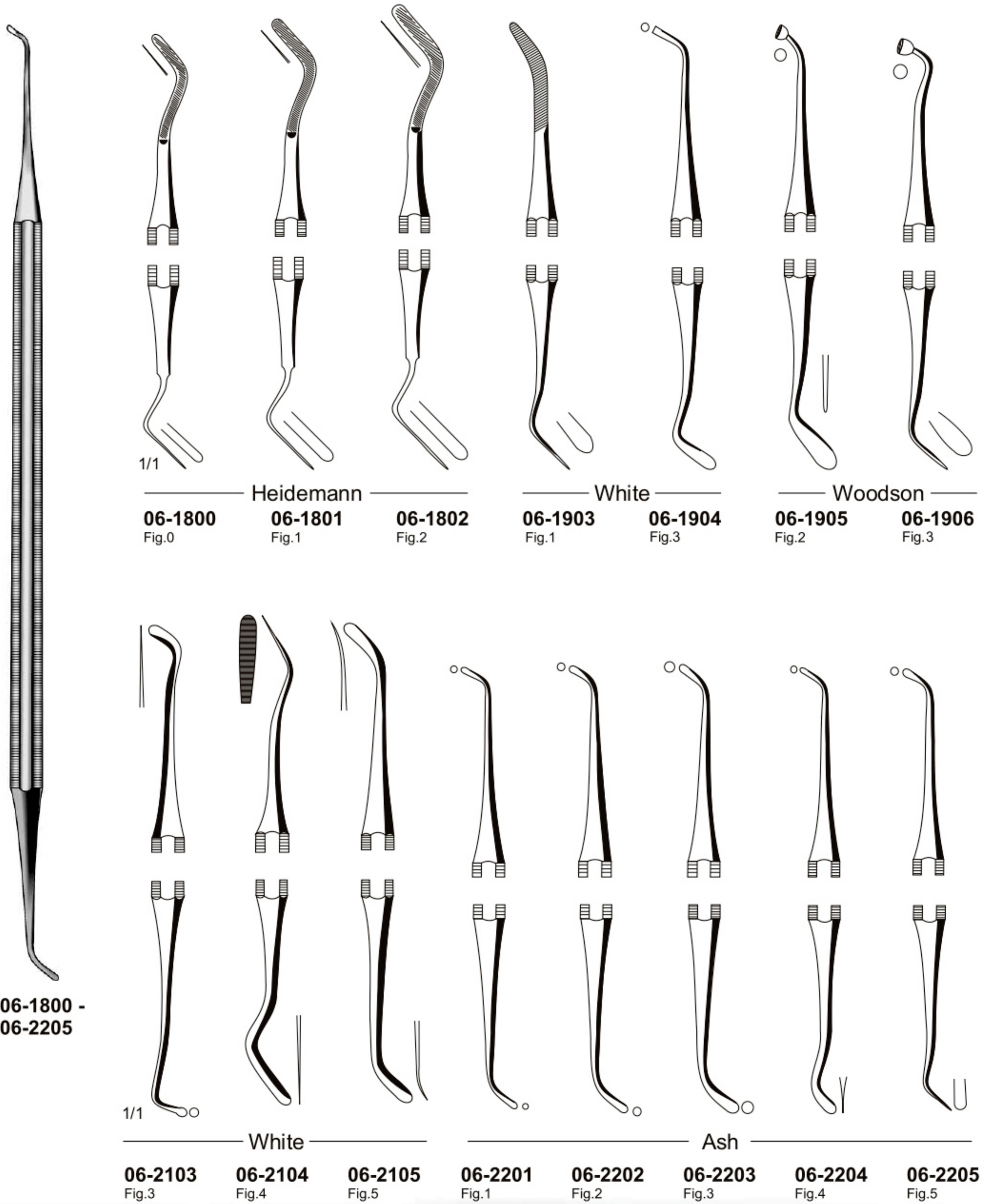



1/1

Mod. PHF

06-2301
Fig.1

06-2302
Fig.2

06-2303
Fig.3

06-2304
Fig.4

06-2305
Fig.5

06-2306
Fig.6

06-2307
Fig.7 A

06-2407
Fig.7 B

**06-2301 -
06-2604**

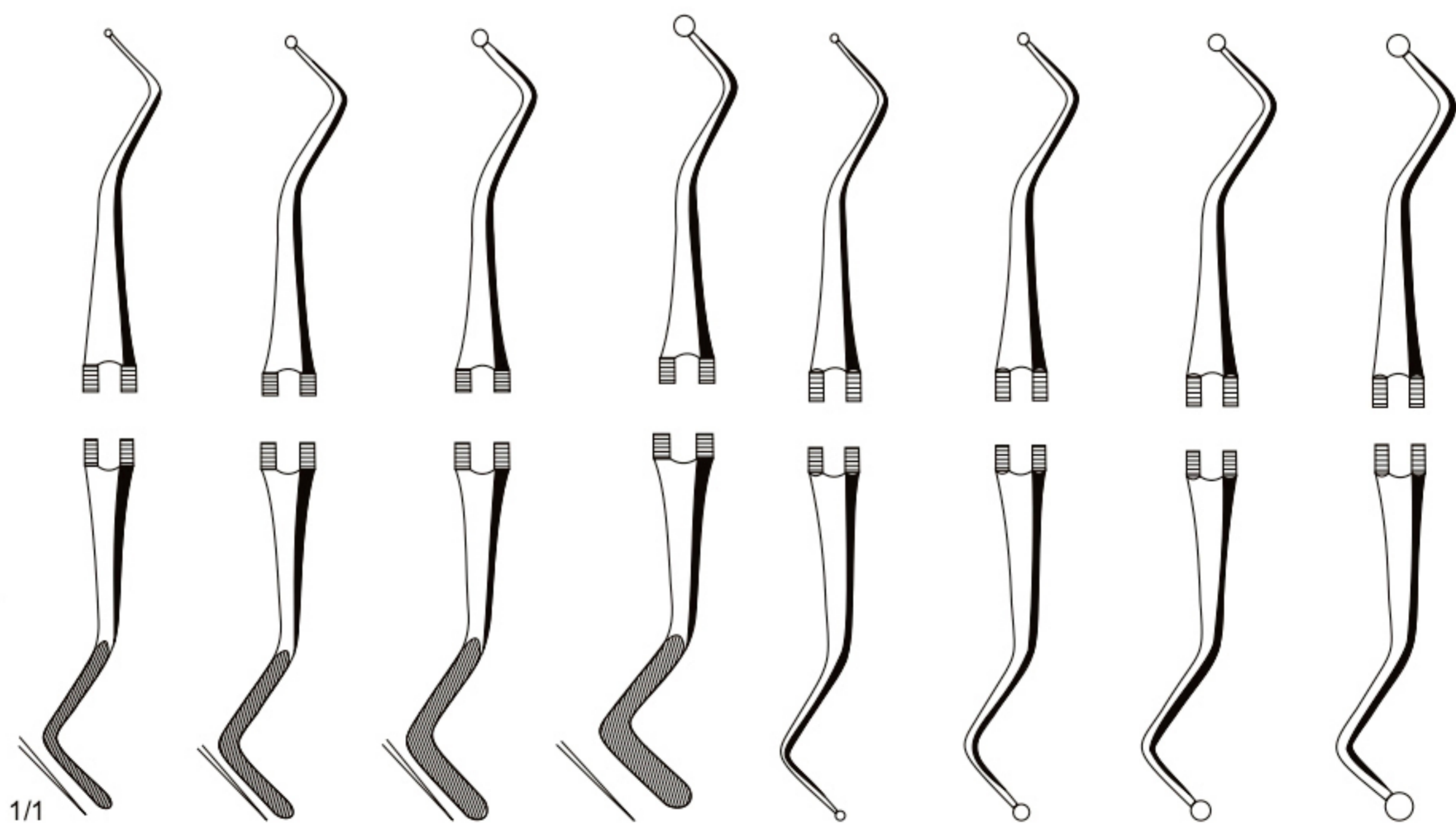

1/1

06-2501
Fig.1

06-2502
Fig.2

06-2503
Fig.3

06-2504
Fig.4

06-2601
Fig.1

06-2602
Fig.2

06-2603
Fig.3

06-2604
Fig.4

Please see page 34 for different handle styles.

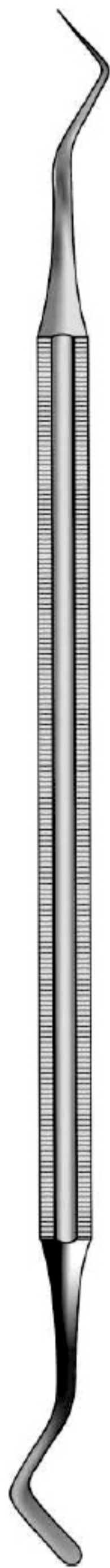

06-2713 - 06-3037

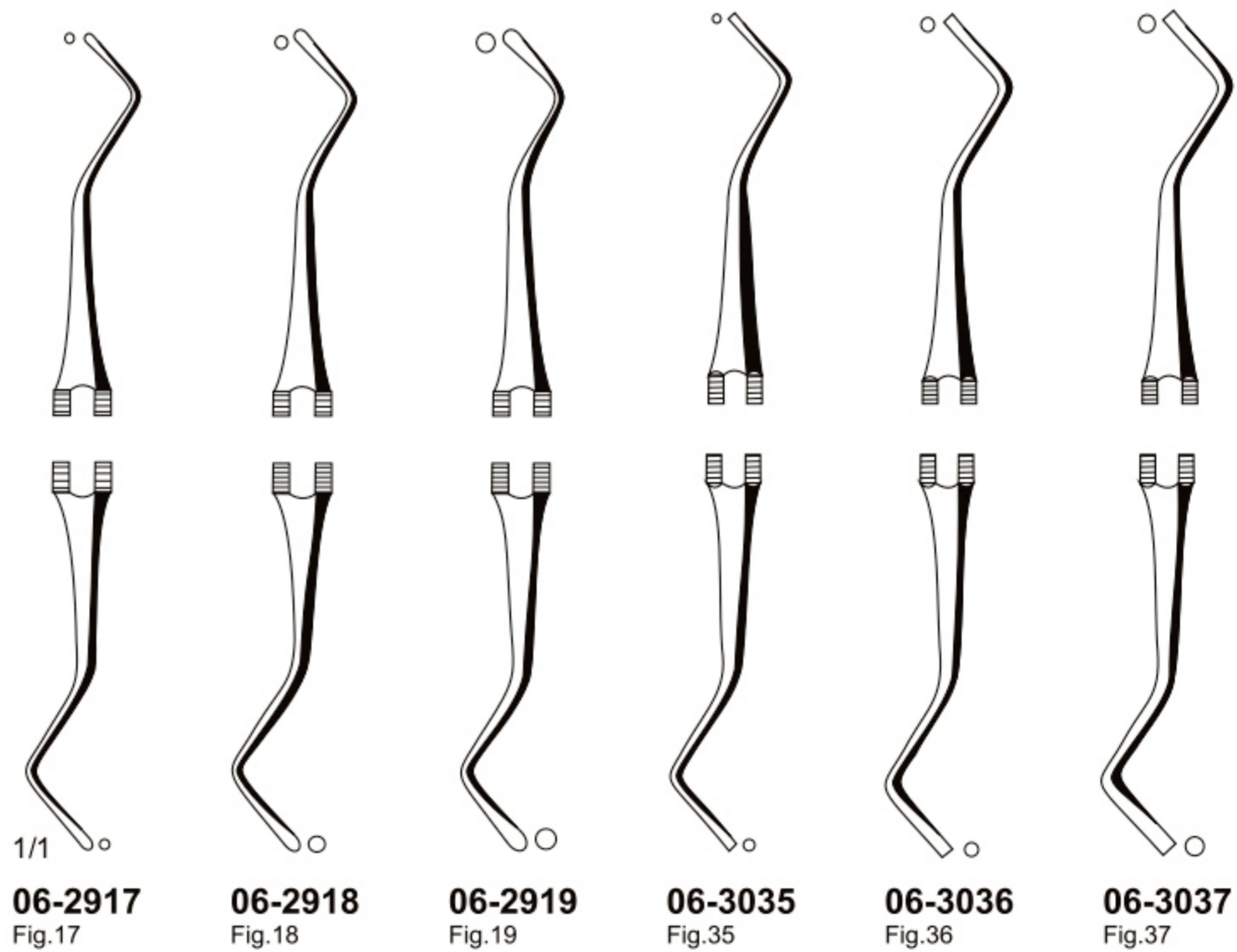
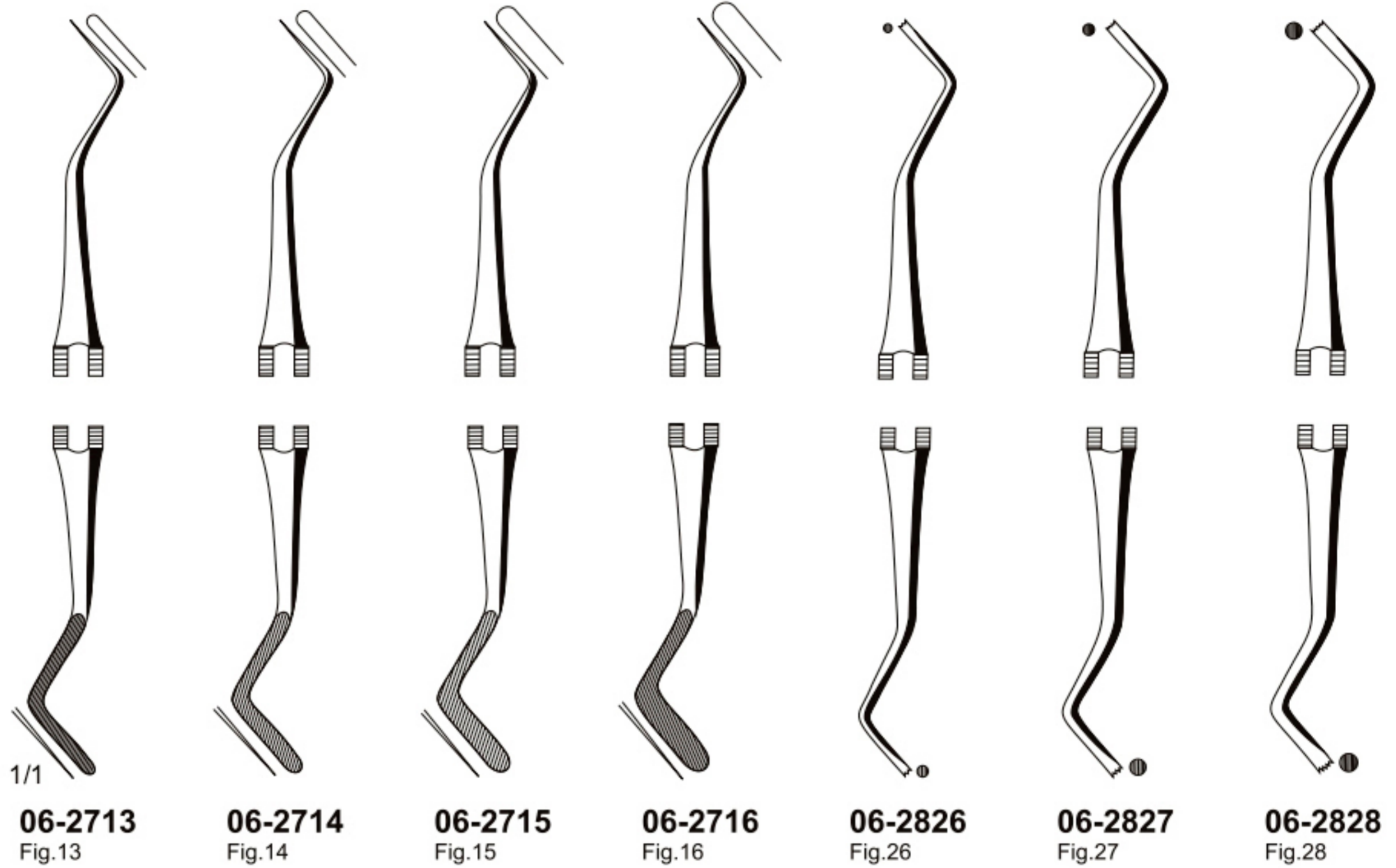



1/1
White
06-3101 - 06-3105



1/1
06-3101



06-3102



06-3103



1/1
06-3104



06-3105

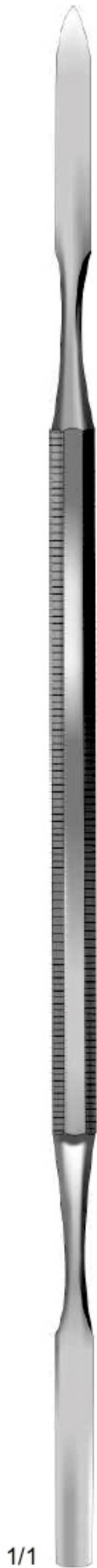

1/1
06-3201 - 06-3203



1/1
06-3201
Fig.1



06-3202
Fig.2



06-3203
Fig.3



06-3301



06-3302

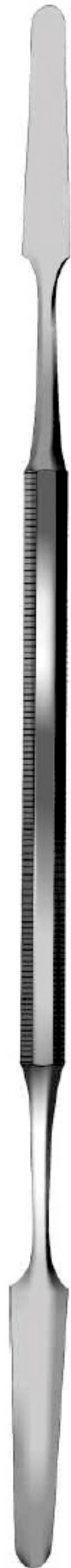

06-3304





07-0134- 07-0618
15.5 cm/ 6"

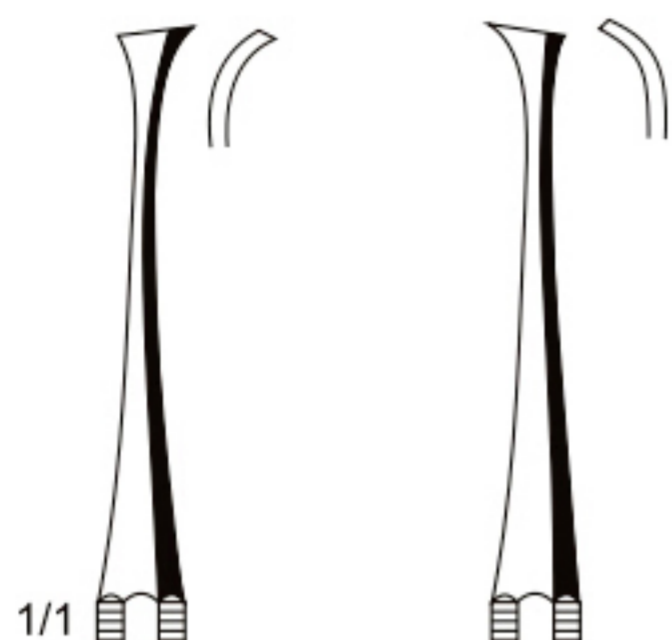

07-0134
Fig.33 ½

07-0135
Fig.34 ½

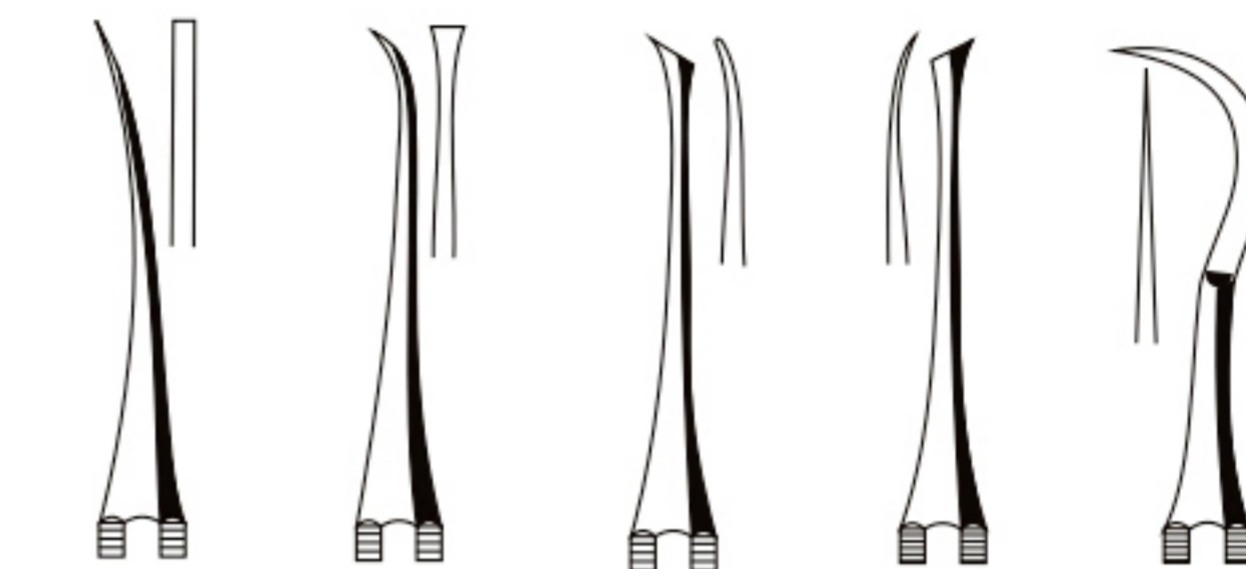

07-0201
Fig.1

07-0204
Fig.4

Darby-Perry

07-0205
Fig.5

07-0206
Fig.6

07-0211
Fig.11

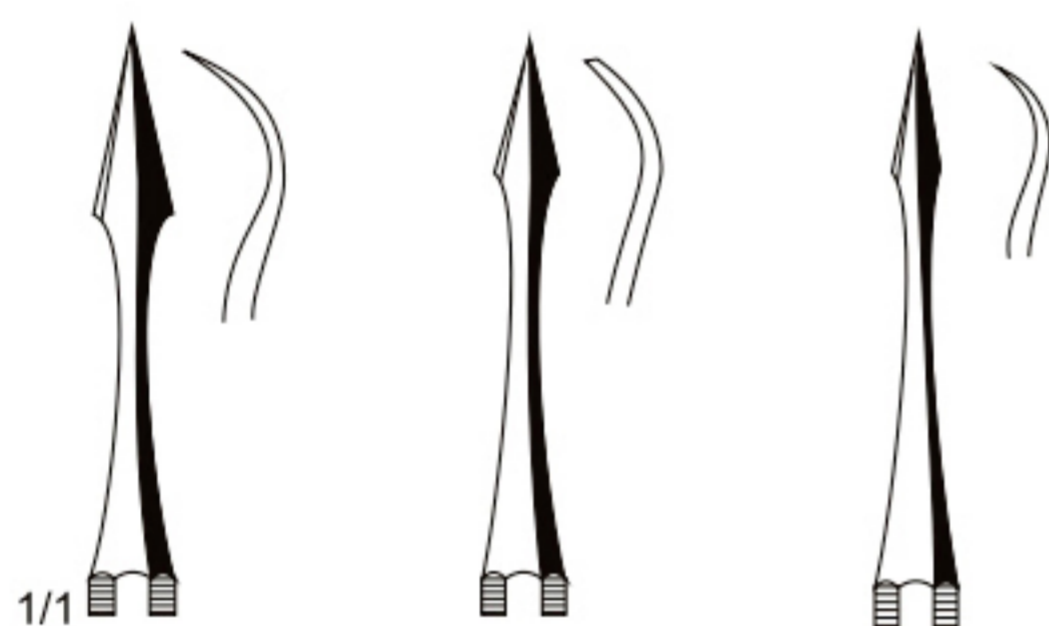

07-0301
Fig.1

07-0302
Fig.2

07-0303
Fig.3



07-0322
Fig.22



07-0333
Fig.33



07-0344
Fig.44



07-0412
Fig.12



07-0533
Fig.33



Jaquette
07-0534
Fig.34



07-0535
Fig.35



07-0617
Fig.17



McCall
07-0618
Fig.18

Please see page 34 for different handle styles.



Columbia
07-0722
Fig. 2 R/2 L



Columbia
07-0744
Fig. 4 R/4 L



Columbia
07-0734
Fig. 13/14



Langer
07-0812
Fig. 1/2



Langer
07-0834
Fig. 3/4



Langer
07-0856
Fig. 5/6

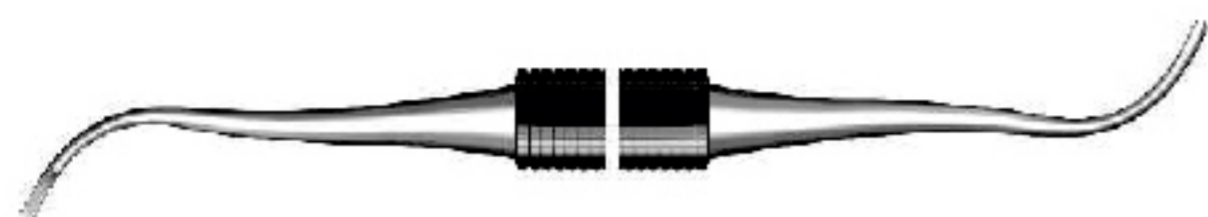

Younger-Good
07-0978
Fig. 7/8

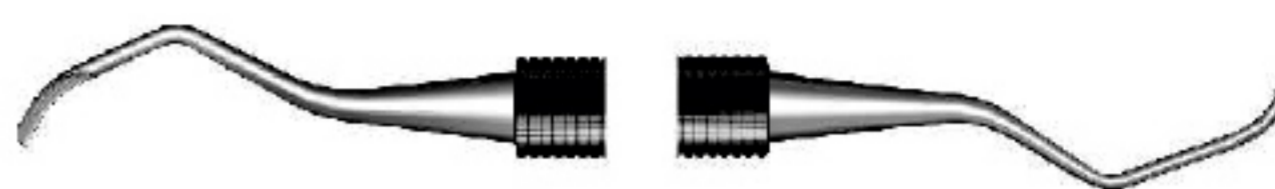

Bates
07-1334
Fig. 135/145



Barnhart
07-1012
Fig. 1/2



Rule
07-1434
Fig. 3/4



Barnhart
07-1056
Fig. 5/6



07-1441
Fig. 411/412

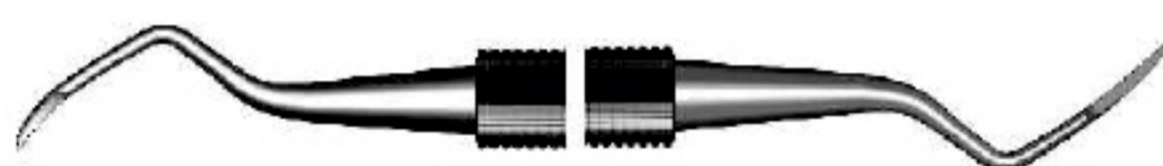

Indiana University (Anterior)
07-1134
Fig. 13/14+

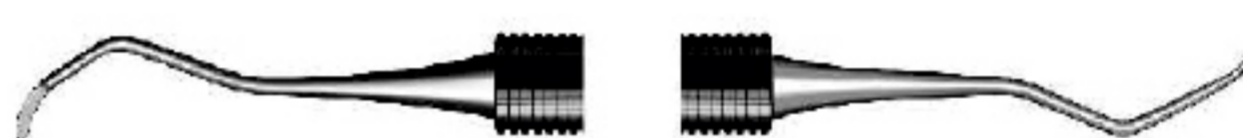

07-1541
Fig. 413/414

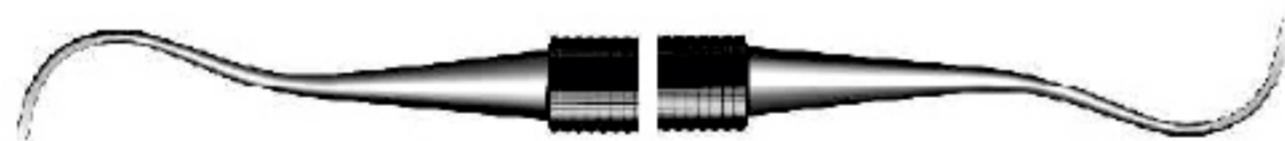

Indiana University (Posterior)
07-1178
Fig. 17/18+

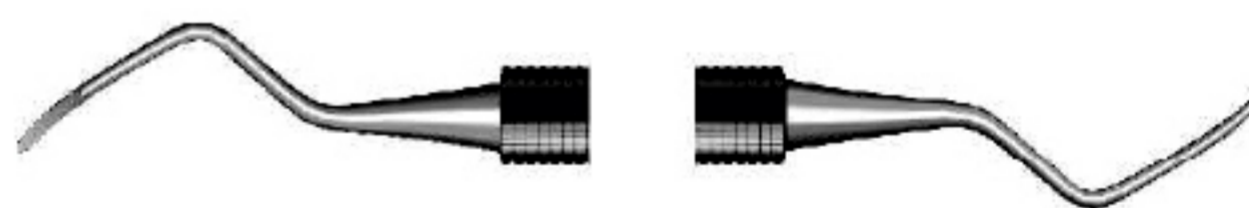

Mallery
07-1612
Fig. 1/2



Bunting
07-1212
Fig. 1/2+

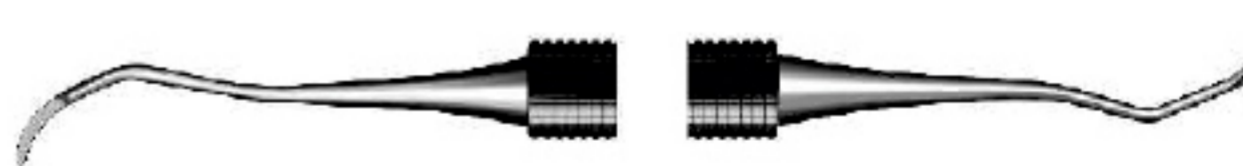

Goldman
07-1632
Fig. 31/32

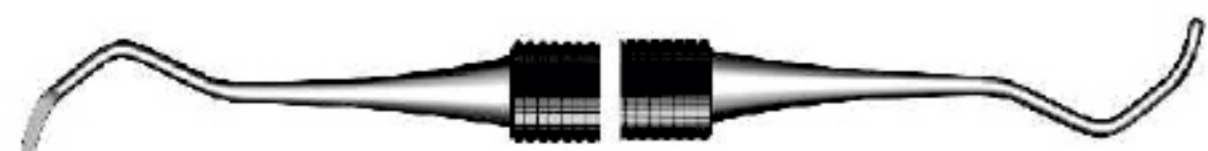

Bunting
07-1256
Fig. 5/6

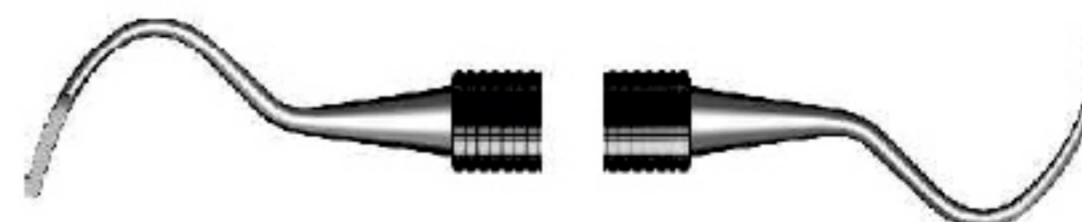

07-1711
Fig. 1



Anterior
07-1812
Fig. 1/2

Please see page 34 for different handle styles.

CH 08

Periodontia Instruments



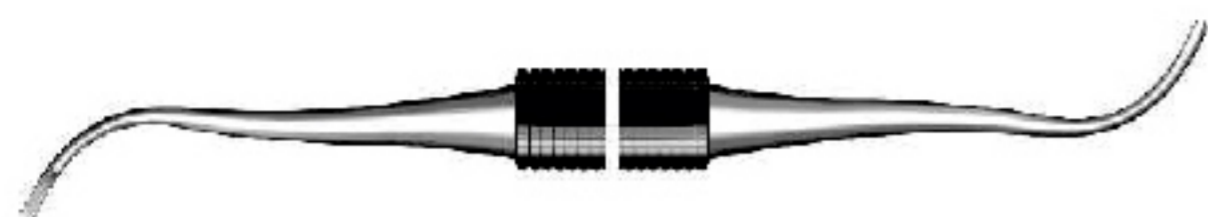

Younger-Good
07-0978
Fig. 7/8

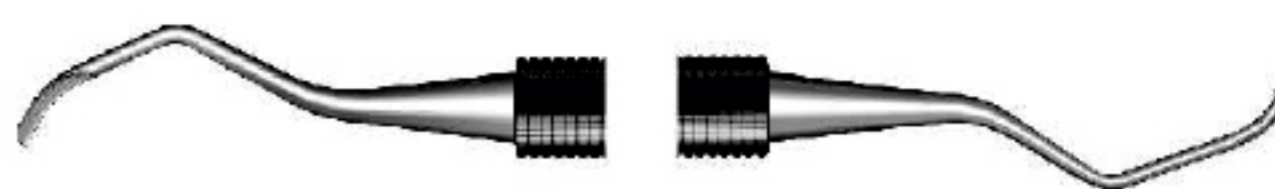

Bates
07-1334
Fig. 135/145



Barnhart
07-1012
Fig. ½



Rule
07-1434
Fig. ¾

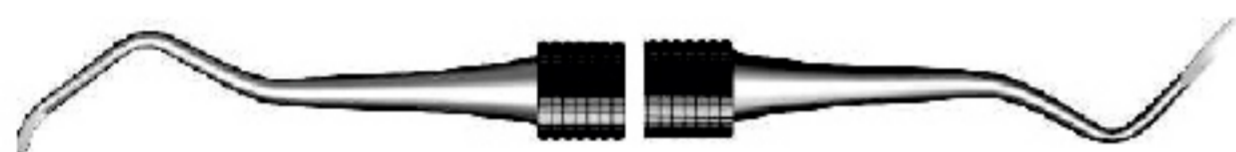

Barnhart
07-1056
Fig. 5/6



07-1441
Fig. 411/412



Indiana University (Anterior)
07-1134
Fig. 13/14+



07-1541
Fig. 413/414

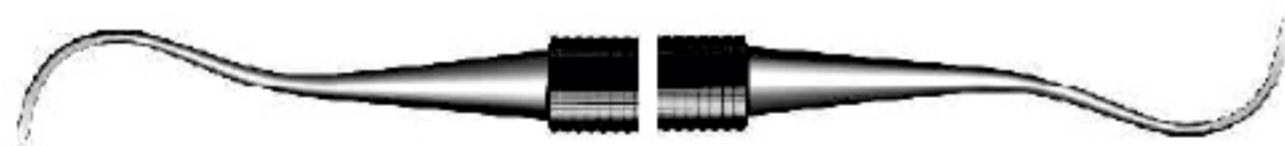

Indiana University (Posterior)
07-1178
Fig. 17/18+

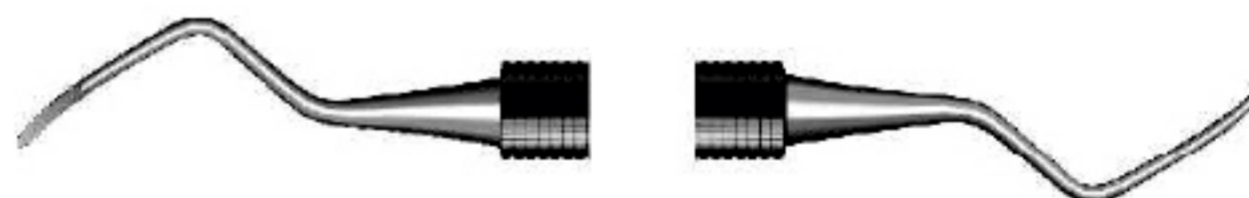

Mallery
07-1612
Fig. ½



Bunting
07-1212
Fig. ½+

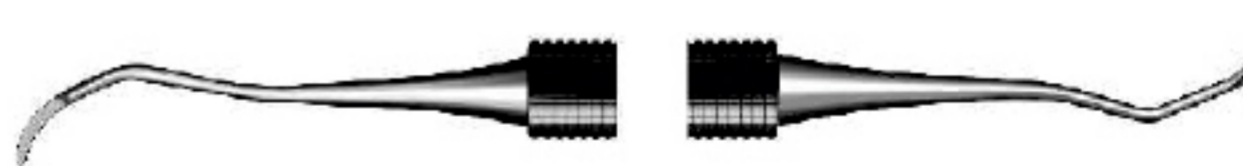

Goldman
07-1632
Fig. 31/32

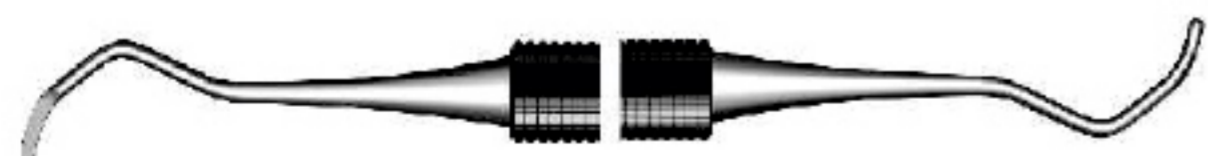

Bunting
07-1256
Fig. 5/6

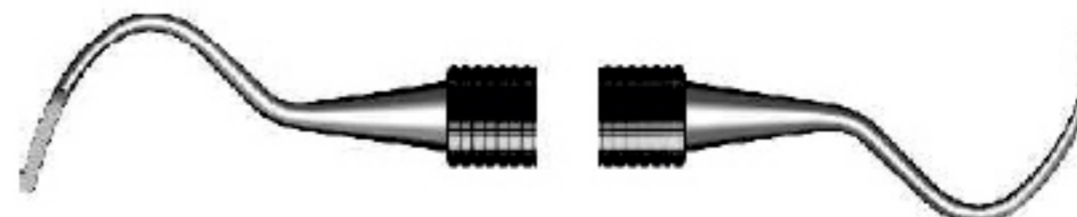

07-1711
Fig. 1



Anterior
07-1812
Fig. ½

Please see page 34 for different handle styles.

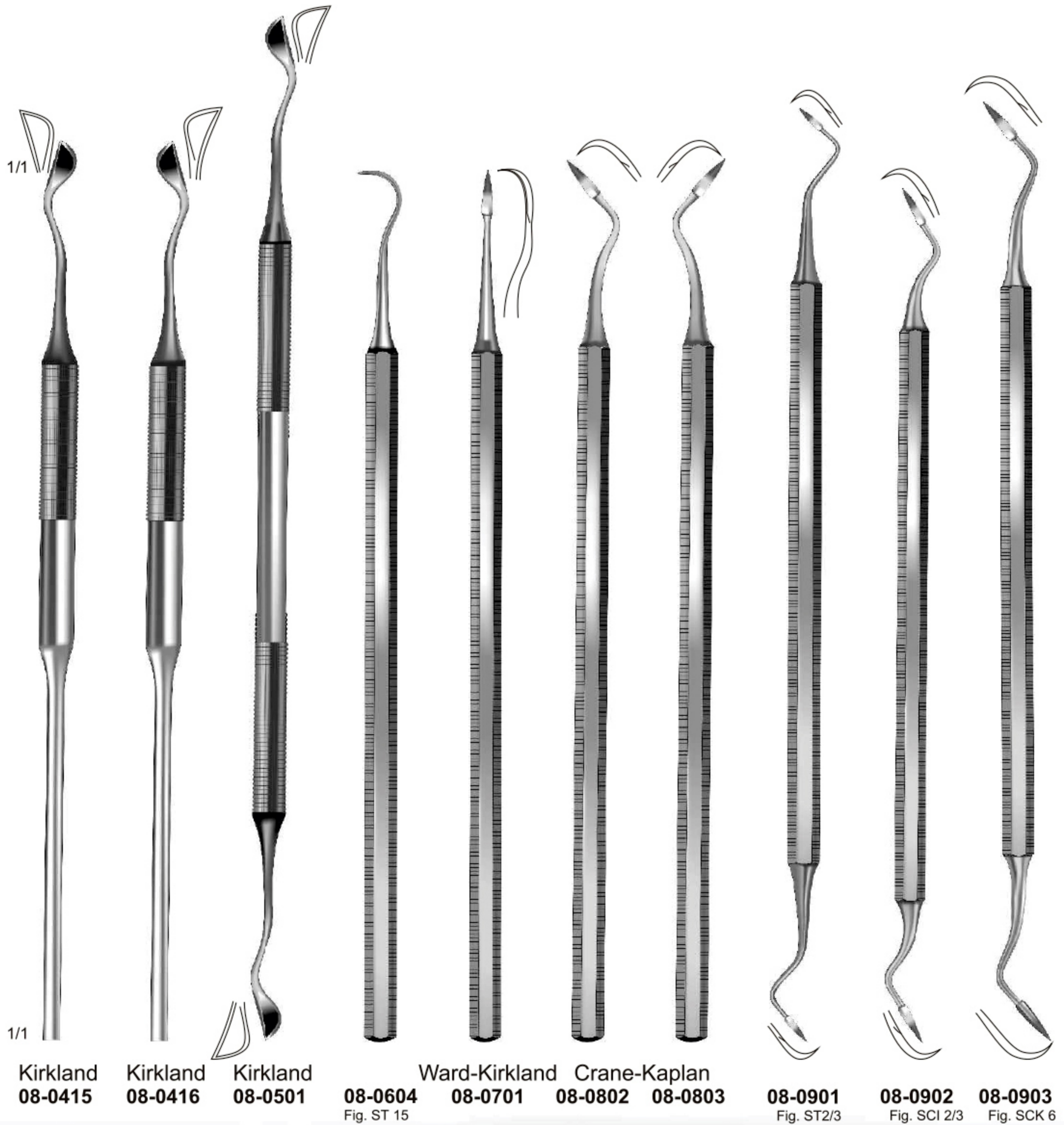

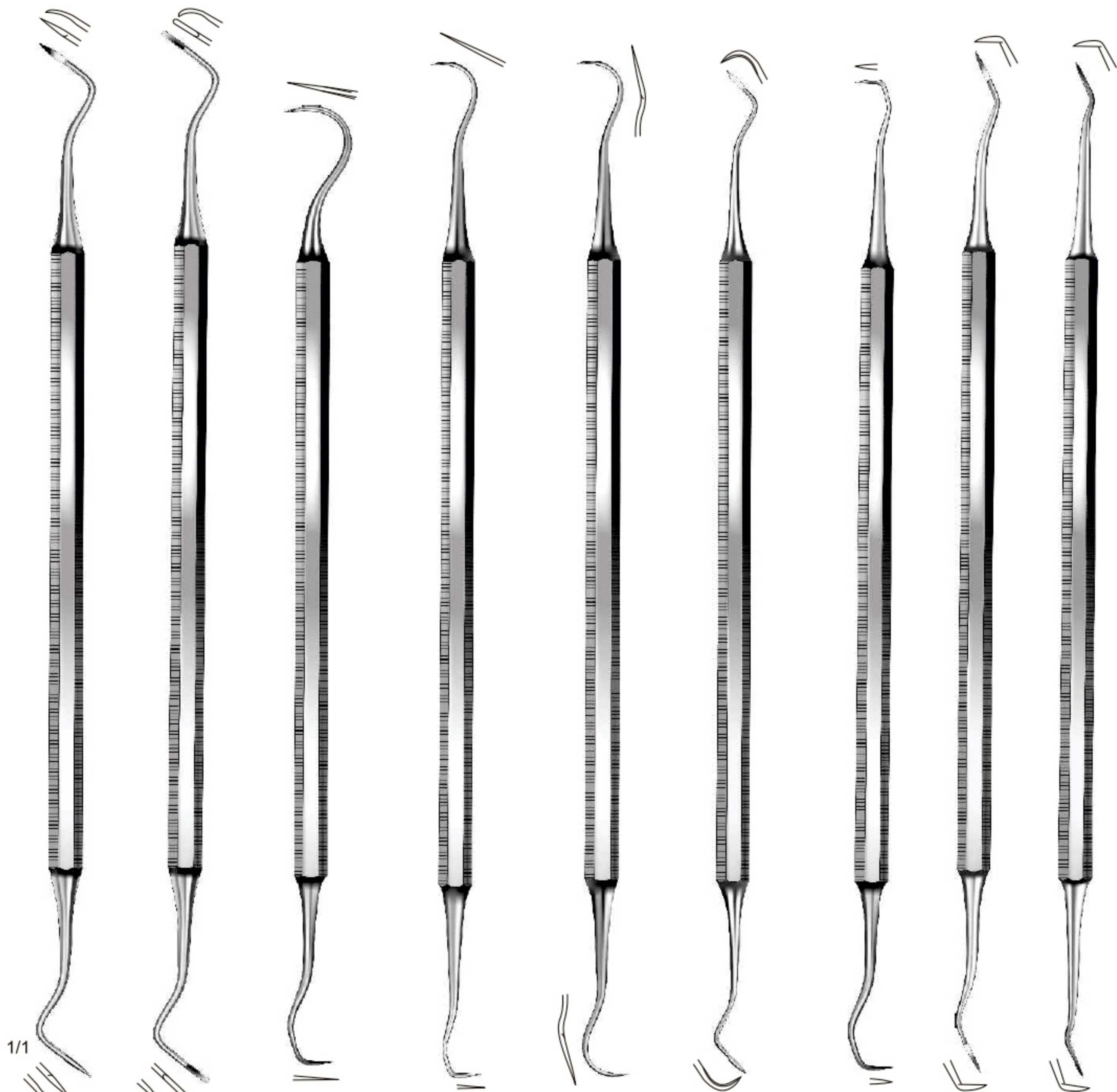

McCall
08-1034
Fig. 13 S/14 S

McCall
08-1134
Fig. 13/14

Towner-Jaquette
08-1230
Fig. 15/30

Hygienist
08-1267
Fig. 5/33

Hygienist
08-1267
Fig. 6/7

08-1304
Fig. 204 S

08-1401
Fig. 30/33

Jaquette
08-1402
Fig. 31/32

08-1403
Fig. 34/35

Please see page 34 for different handle styles.



08-1507 08-1508 08-1509 Goldman-Fox 08-1510 08-1511 08-1521 Nabers Cross Prichard
08-1600 08-1601 08-1700

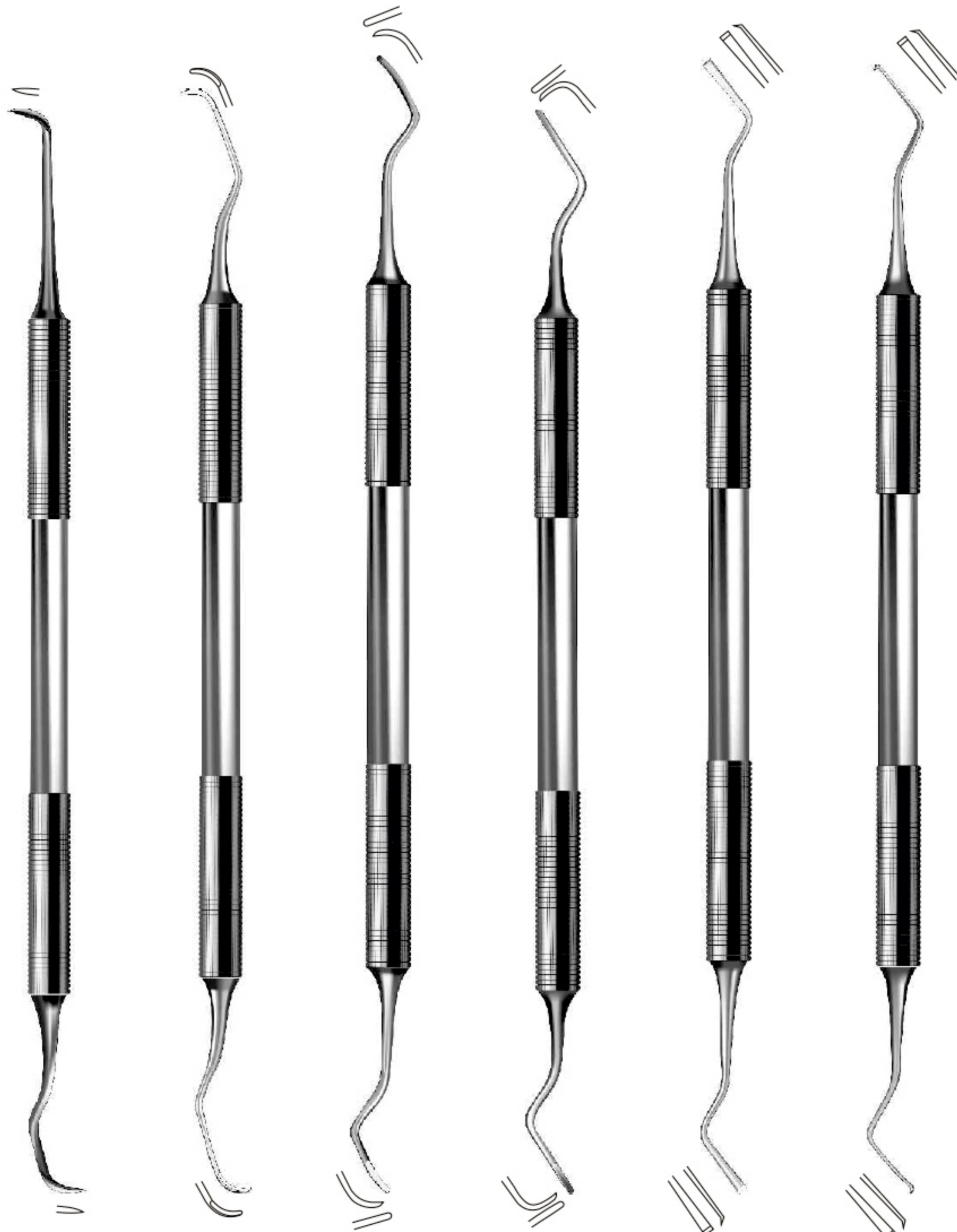

Goldman Fox

08-2101
16cm/ 6 1/4"

08-2102
16cm/ 6 1/4"

08-2103
16cm/ 6 1/4"

08-2104
16cm/ 6 1/4"

08-2105
16cm/ 6 1/4"

08-2106
16cm/ 6 1/4"

Please see page 34 for different handle styles.

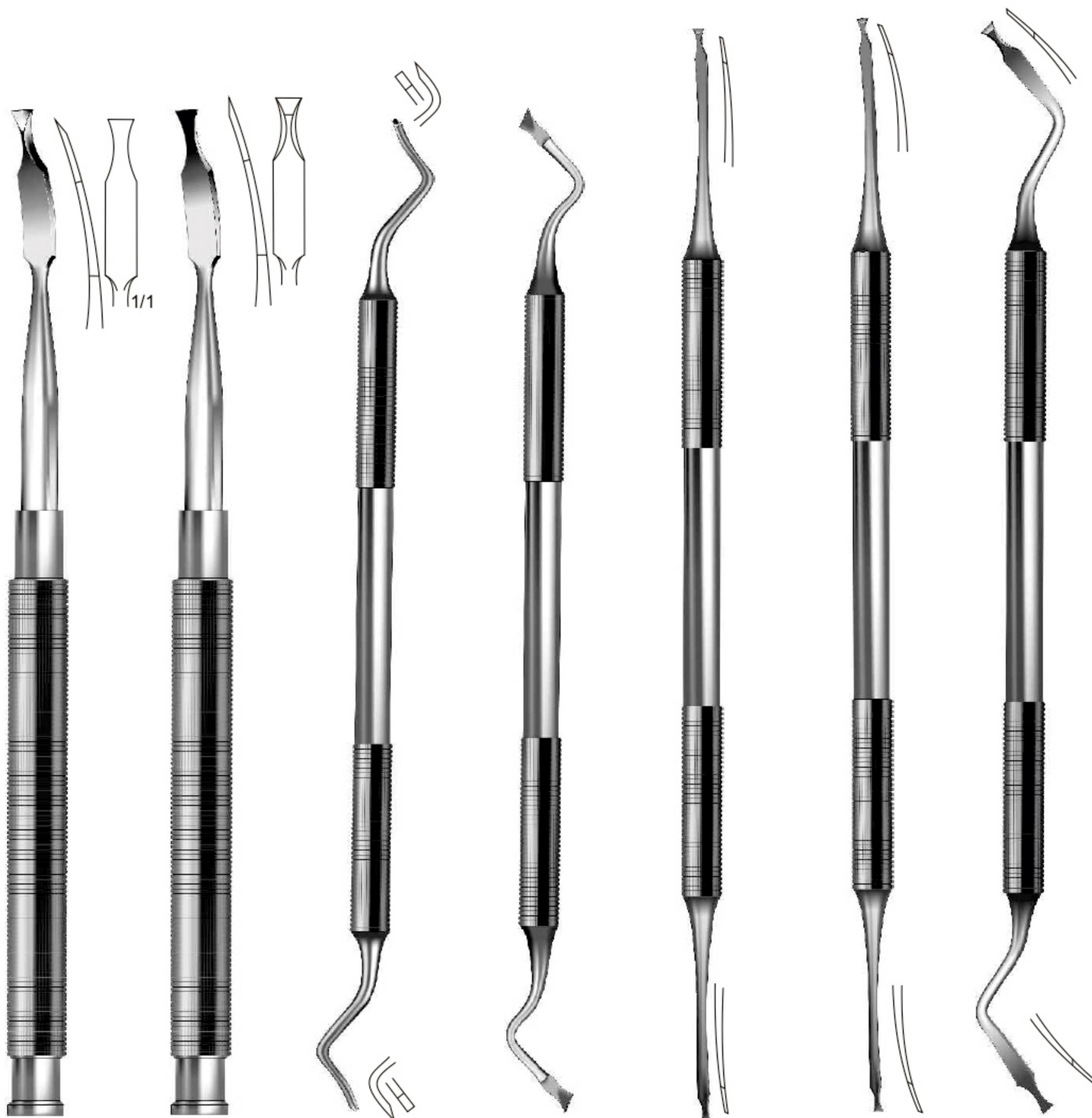

**Ochsenbein
08-2201**
Fig. 1

**Ochsenbein
08-2202**
Fig. 2

**Ochsenbein
08-2303**
Fig. 3

**Ochsenbein
08-2304**
Fig. 4

**Fedi
08-2501**
Fig. 1

**Fedi
08-2502**
Fig. 2

**Fedi
08-2503**
Fig. 3

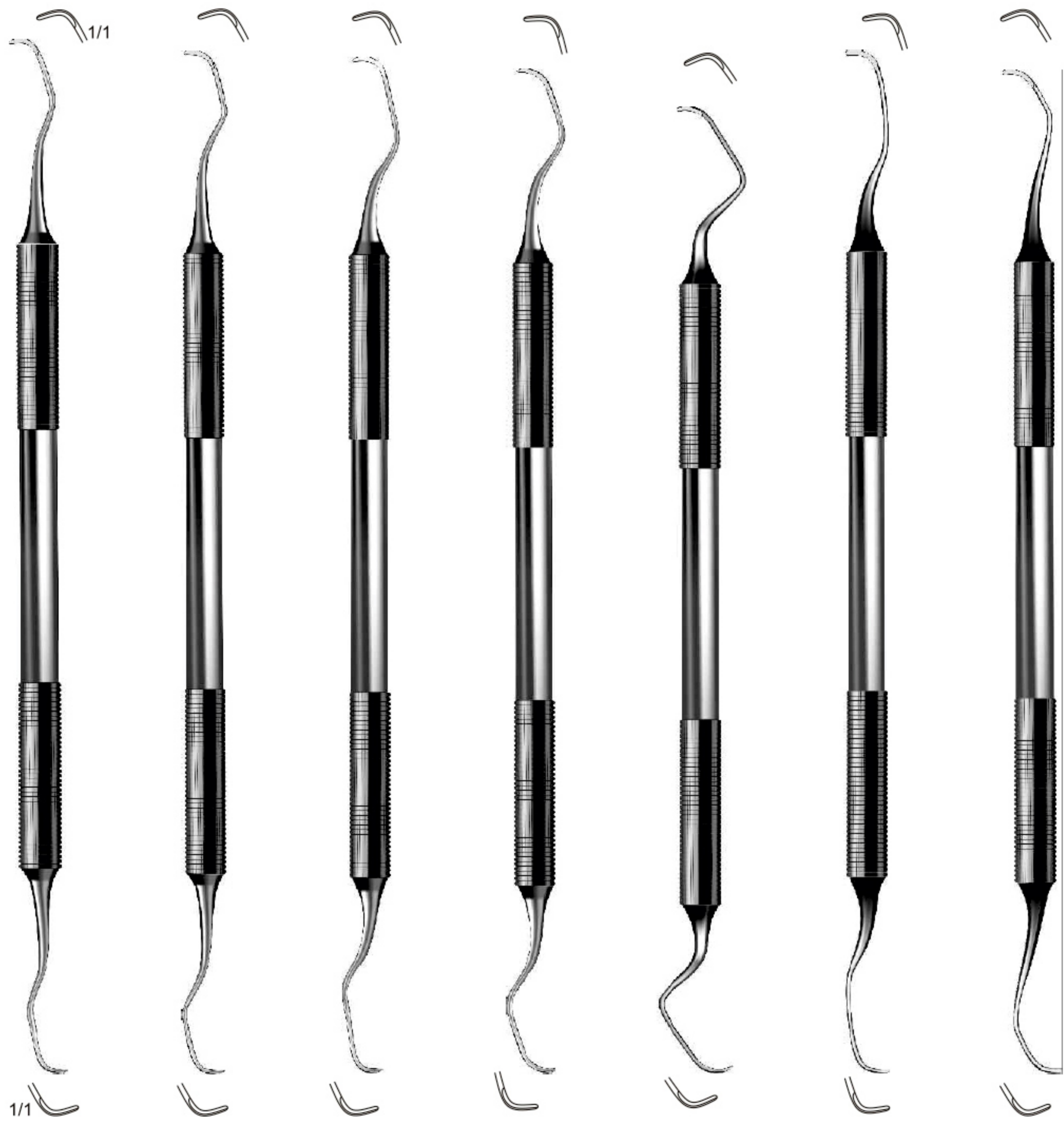

08-2612
Fig. 1/2

08-2634
Fig. 3/4

08-2656
Fig. 5/6

Gracey
08-2678
Fig. 7/8

08-2690
Fig. 9/10

08-2692
Fig. 11/12

08-2694
Fig. 13/14

Please see page 34 for different handle styles.

CH 09

**Excavators, Probes &
Explorers, Nerve instruments**



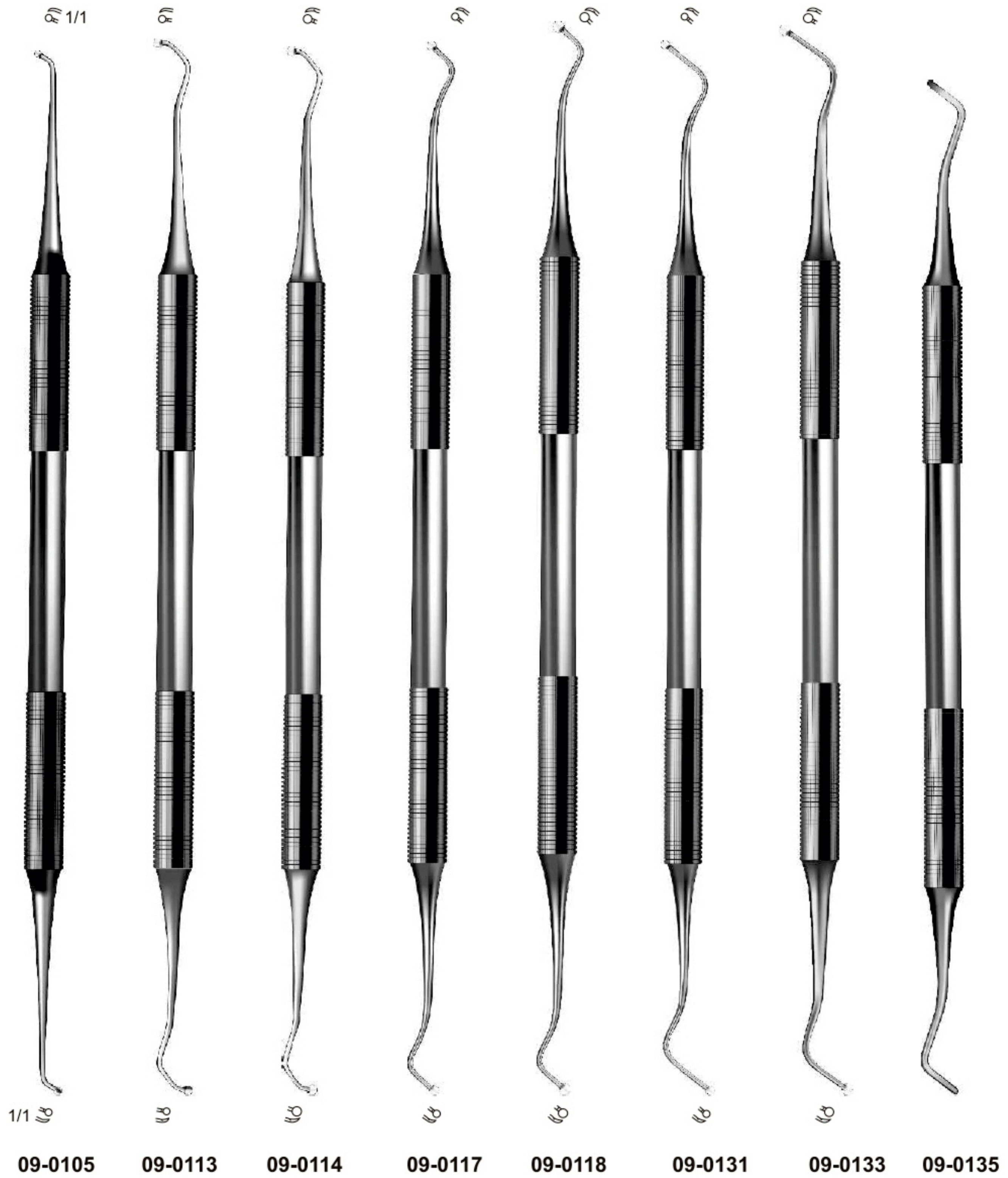

Please see page 34 for different handle styles.

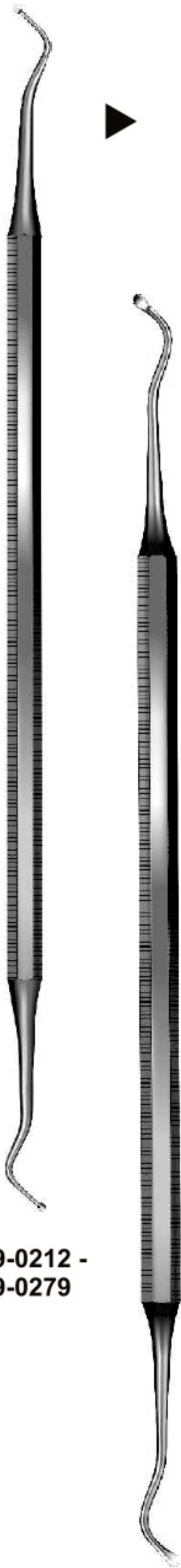

09-0212 -
09-0279

09-0305 -
09-0320

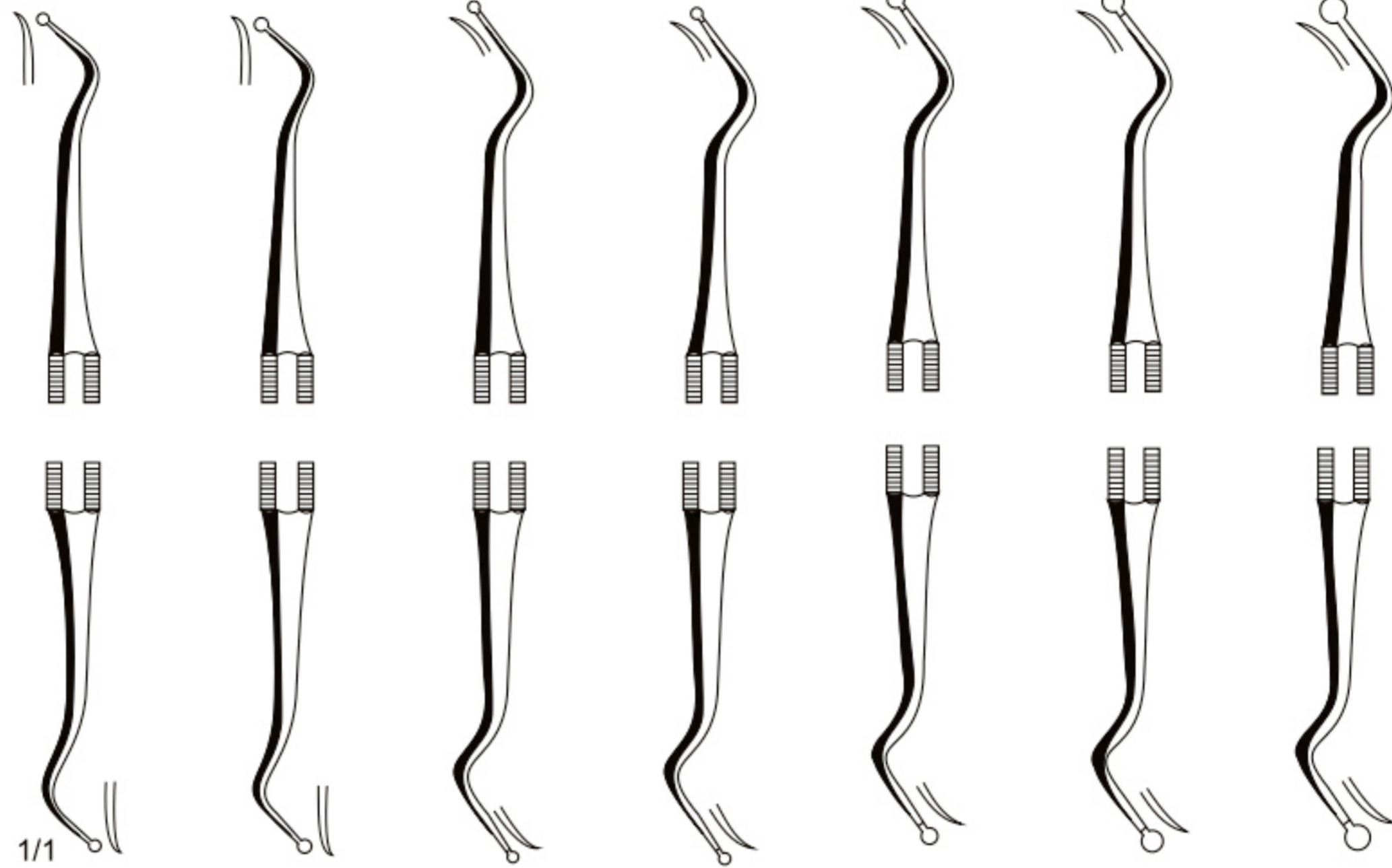

09-0212 Fig. 12/13 09-0214 Fig. 14/15 09-0217 Fig. 171/172 09-0273 Fig. 173/174 09-0275 Fig. 175/176 09-0277 Fig. 177/178 09-0279 Fig. 179/180



09-0305 Fig. 5 09-0314 Fig. 14 09-0317 Fig. 17 09-0318 Fig. 18 09-0319 Fig. 19 09-0320 Fig. 20

White

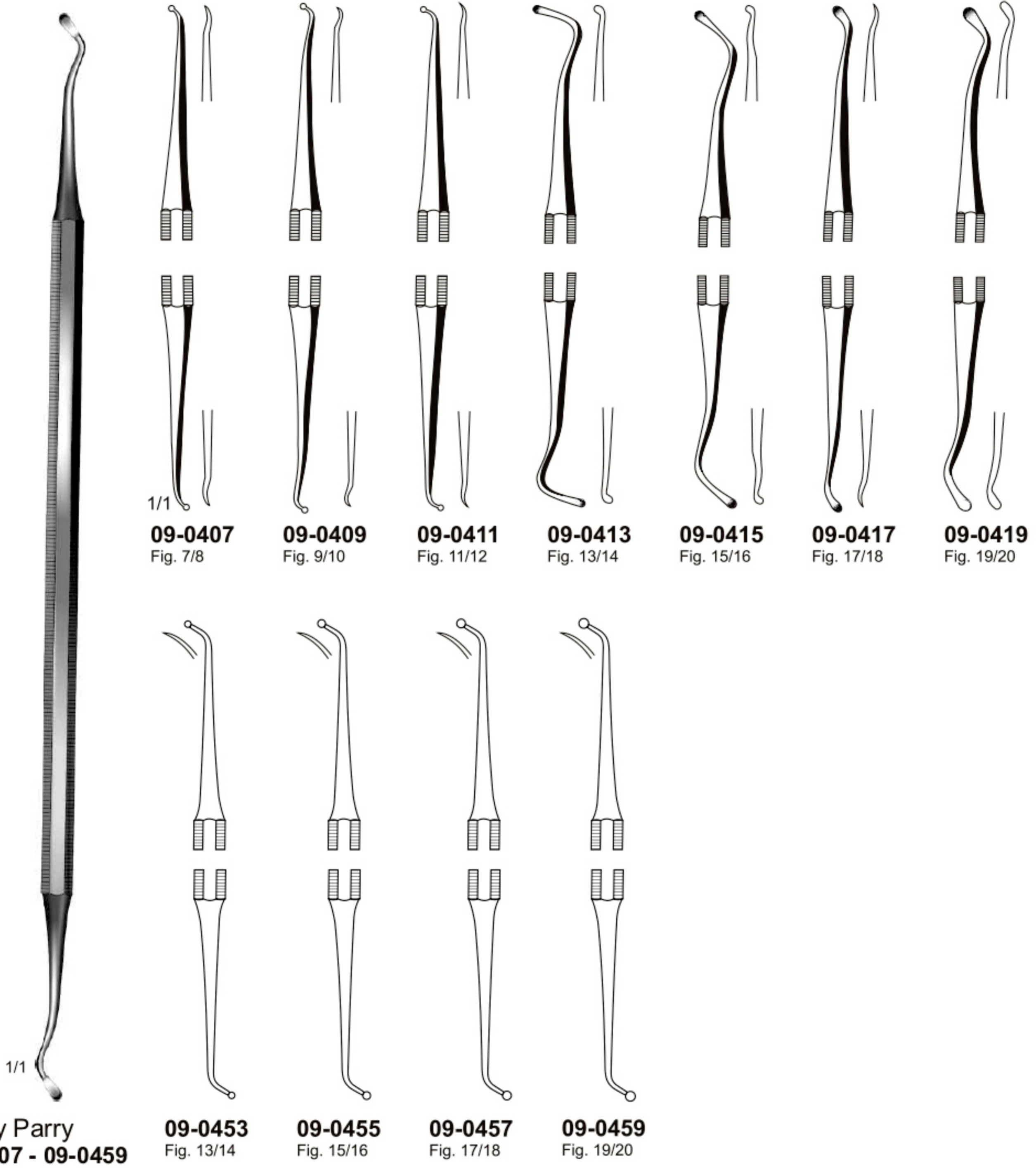

Darby Parry
09-0407 - 09-0459

09-0453
Fig. 13/14

09-0455
Fig. 15/16

09-0457
Fig. 17/18

09-0459
Fig. 19/20



09-0503-
09-0525



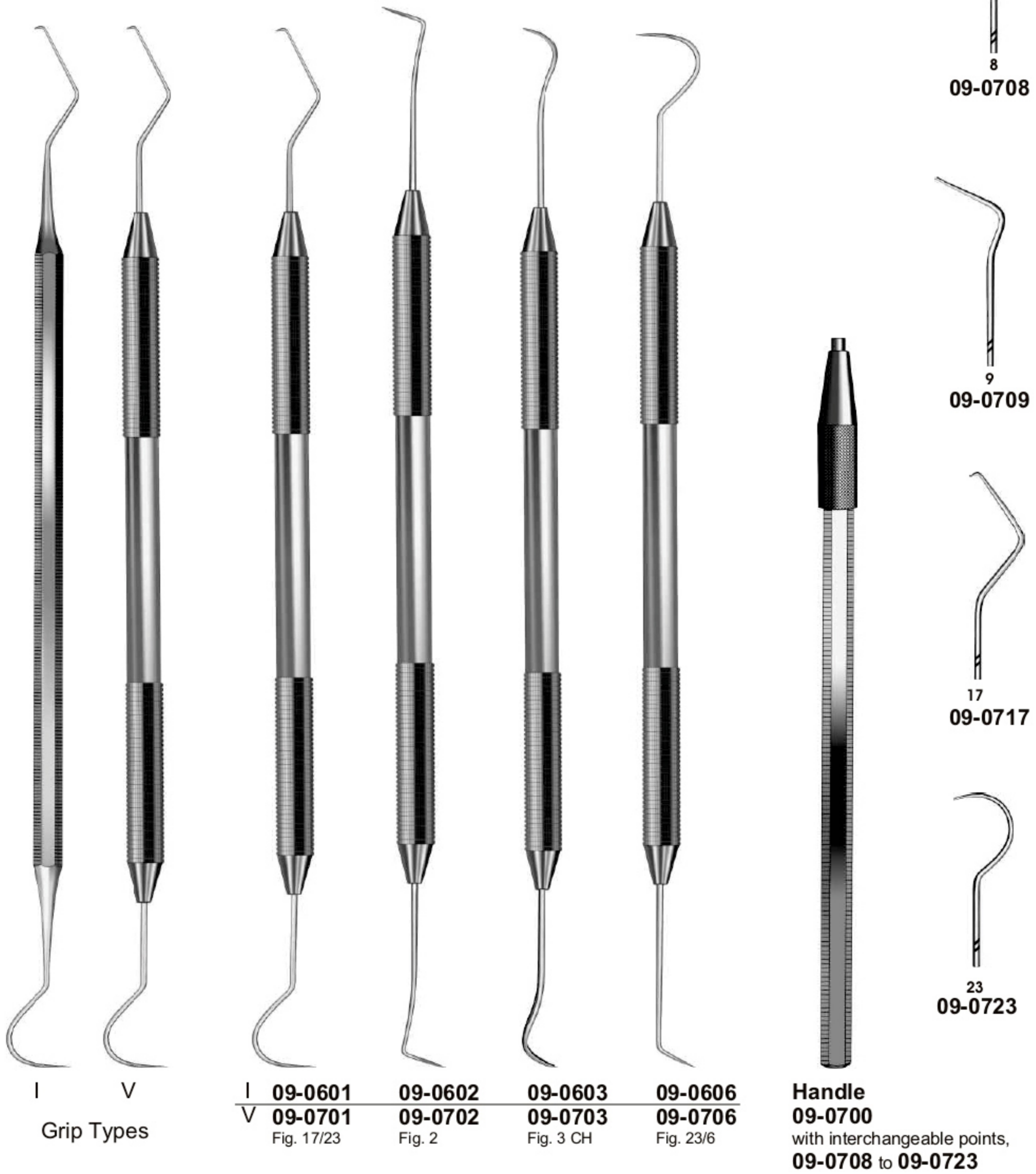

Please see page 34 for different handle styles.

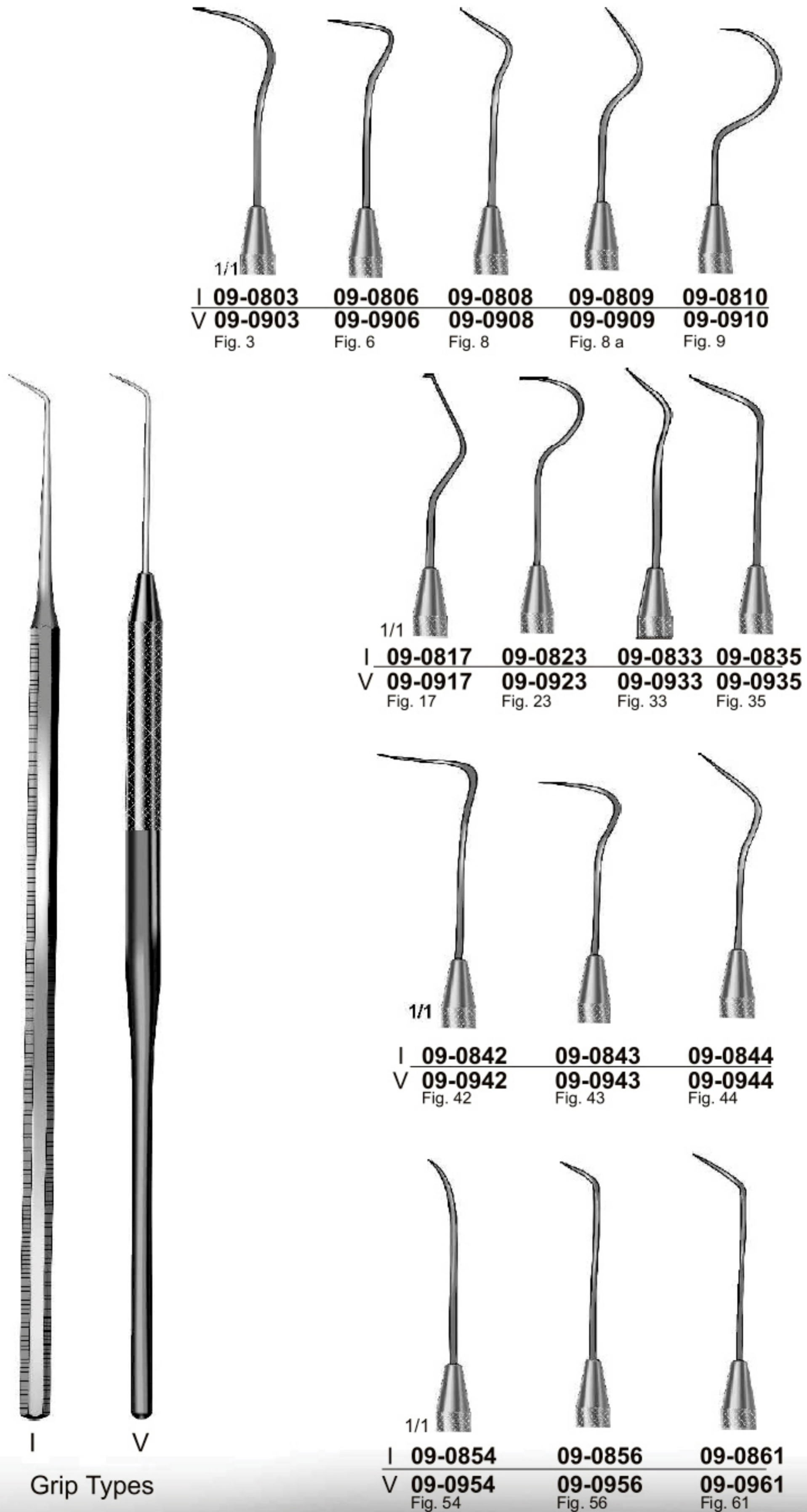

Nerve-canal and Root-Canal Condensers

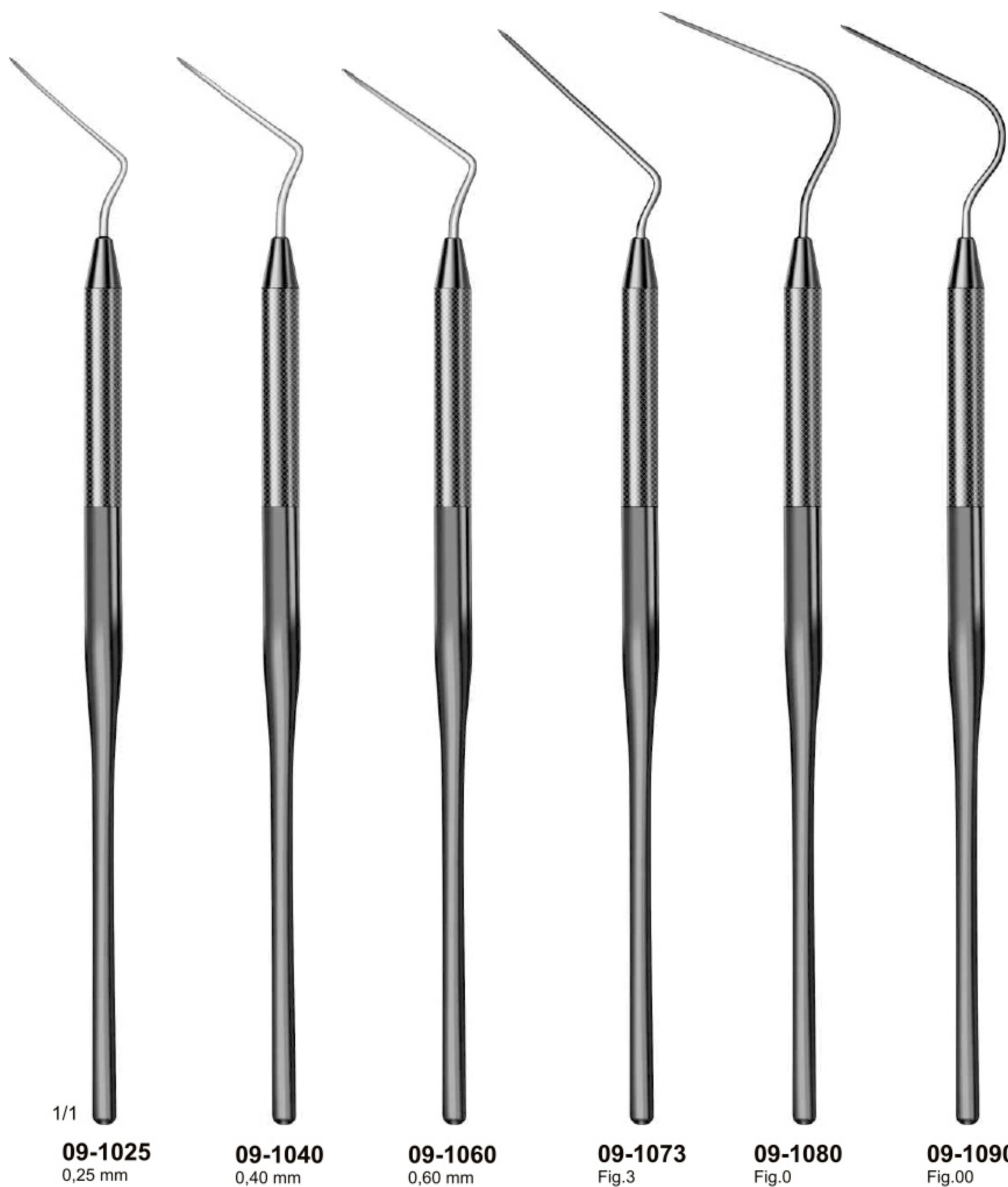

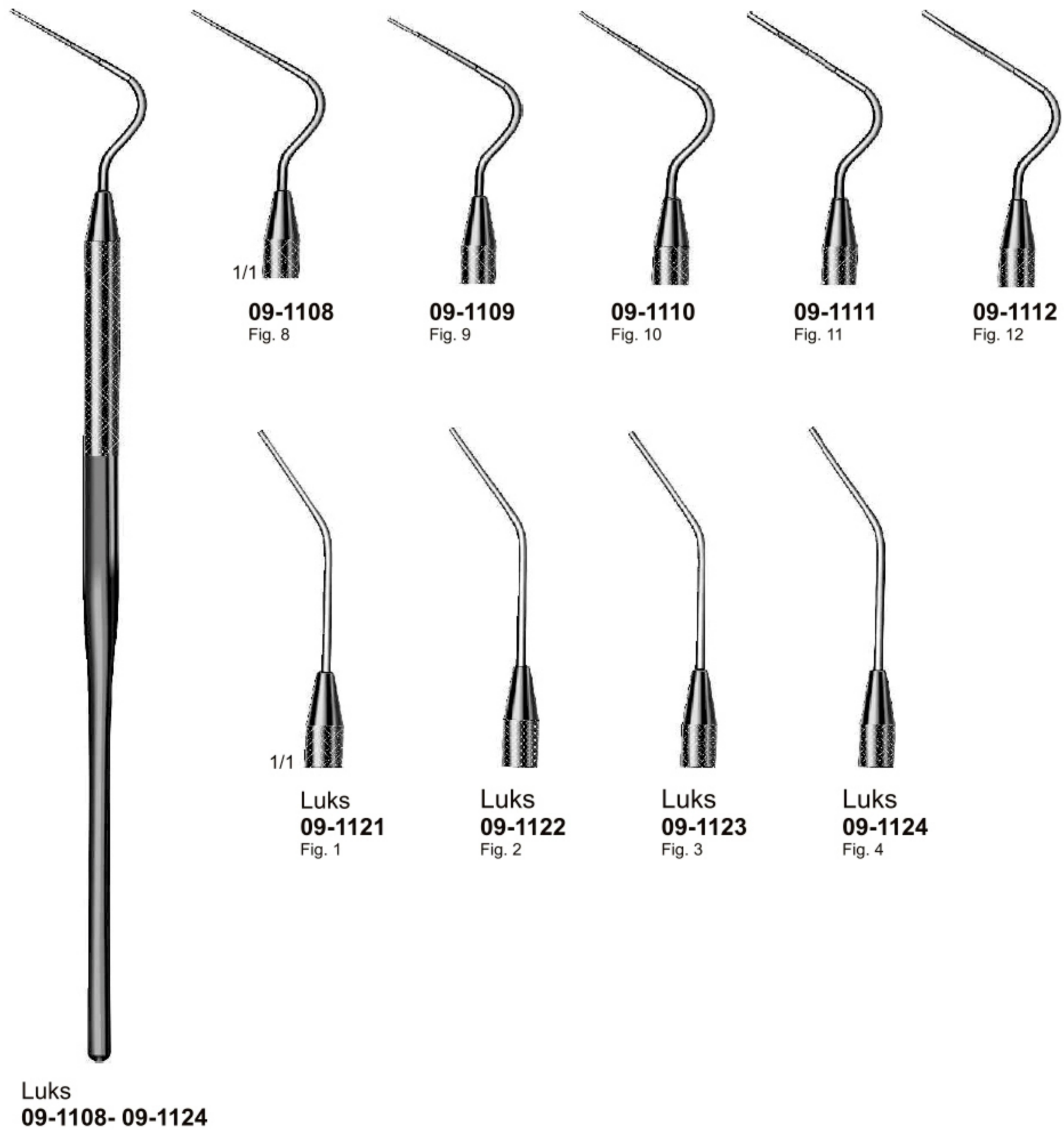

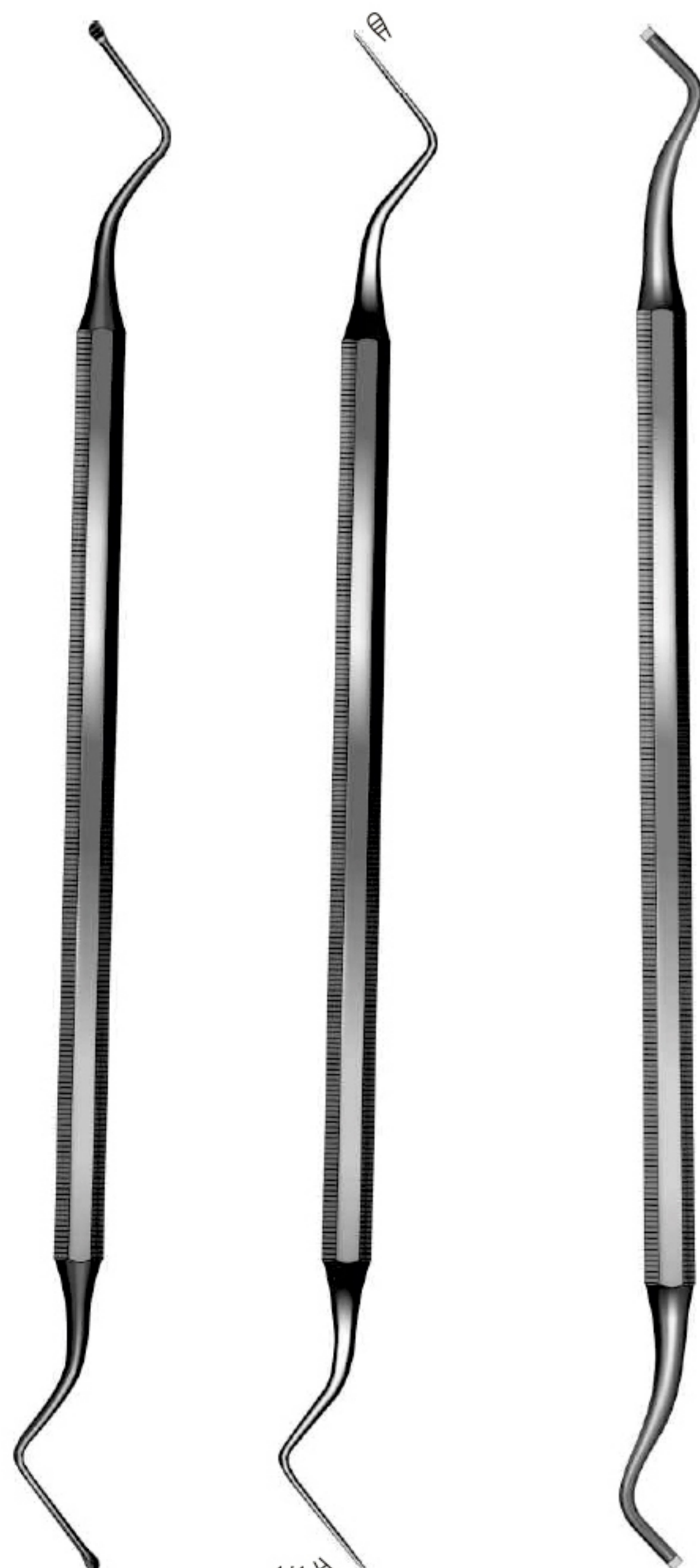

Hirschfeld
09-1237
Fig. 3/7

1/1
Hirschfeld
09-1211
Fig. 5/11

Black
09-1351 - 09-1379

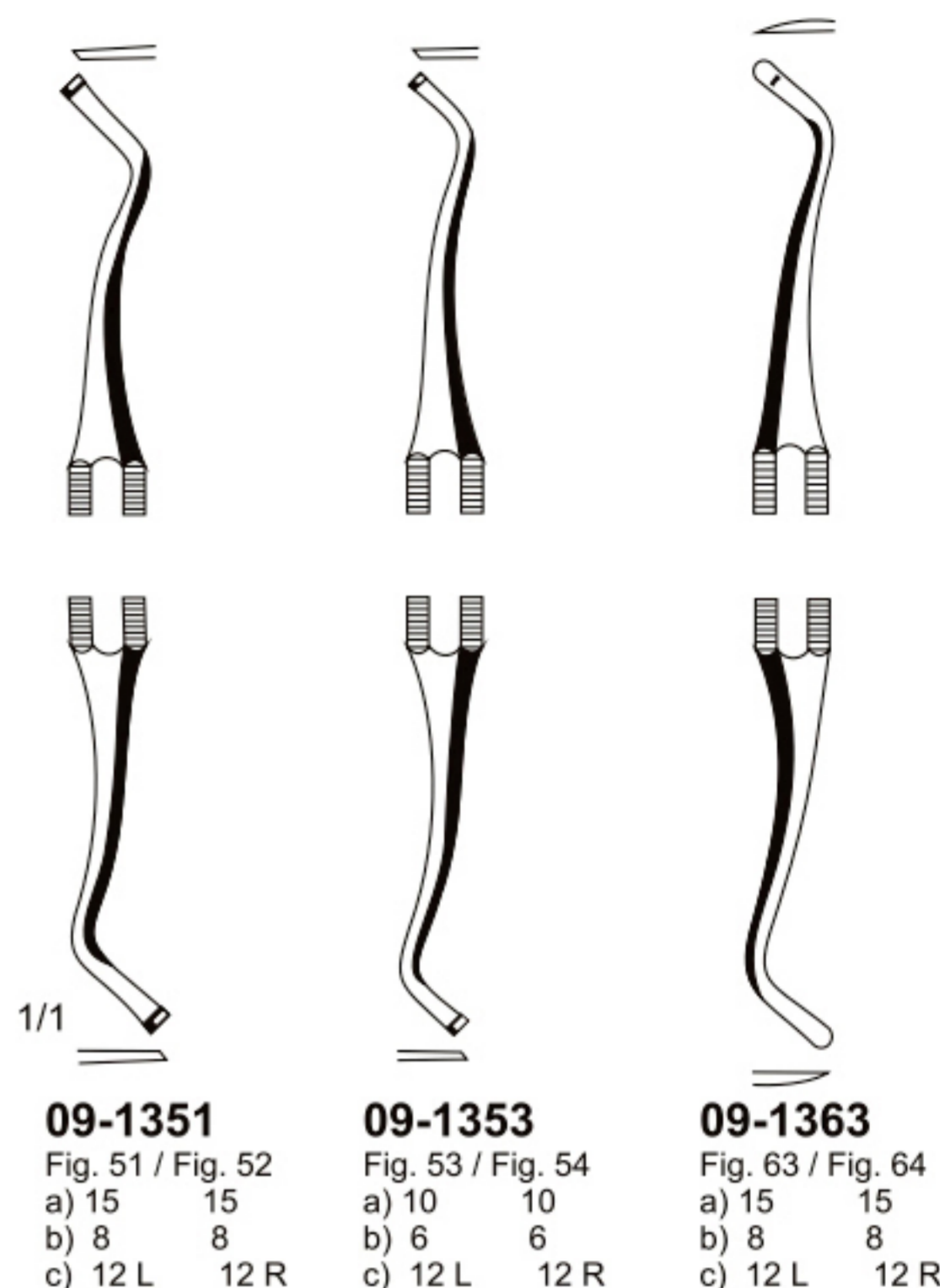

09-1351
Fig. 51 / Fig. 52
a) 15 15
b) 8 8
c) 12 L 12 R

09-1353
Fig. 53 / Fig. 54
a) 10 10
b) 6 6
c) 12 L 12 R

09-1363
Fig. 63 / Fig. 64
a) 15 15
b) 8 8
c) 12 L 12 R

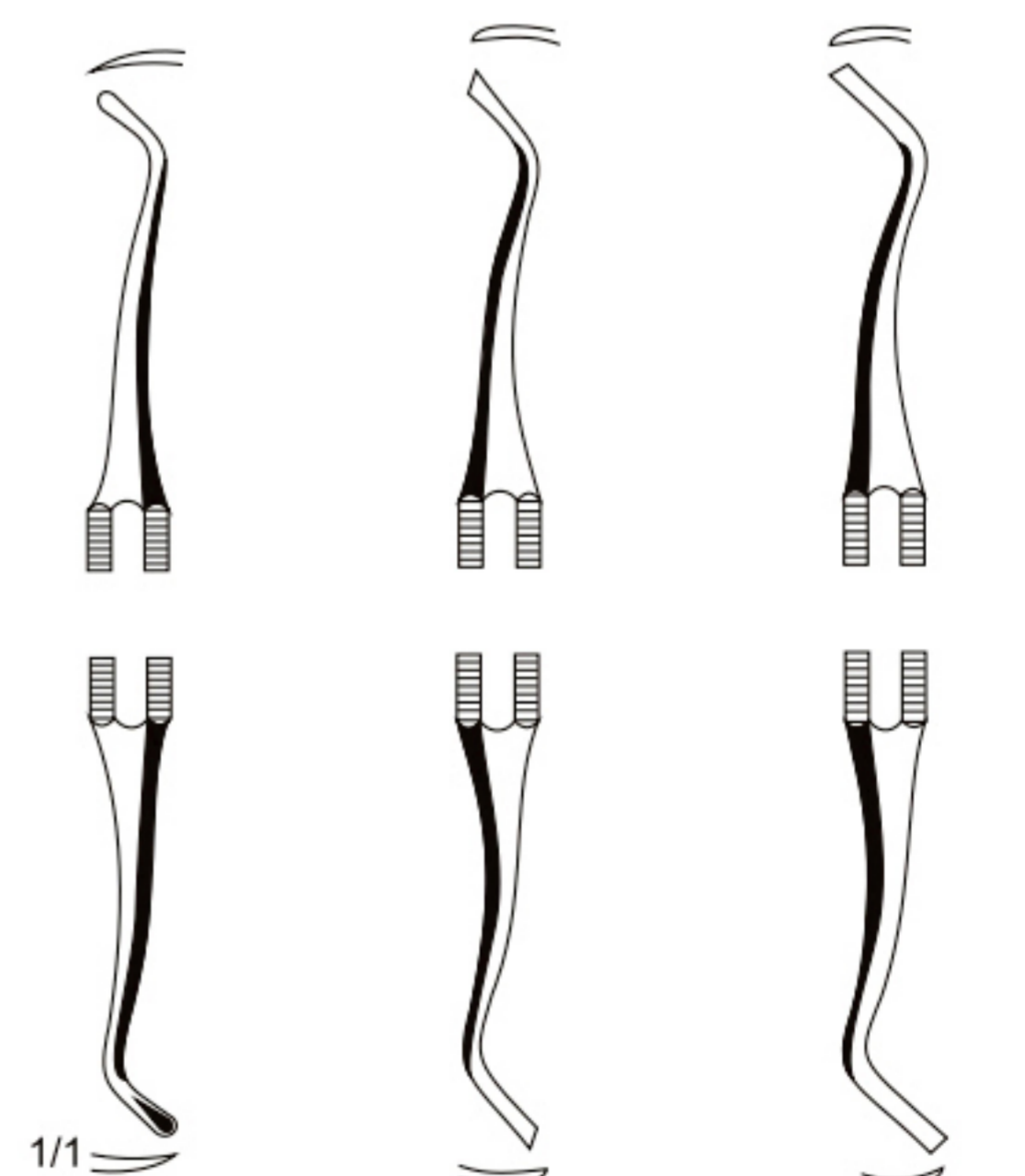

09-1365
Fig. 65 / Fig. 66
a) 10 10
b) 8 6
c) 12 L 12 R

09-1377
Fig. 77 / Fig. 78
a) 15 15
b) 8 8
c) 12 L 12 R

09-1379
Fig. 79 / Fig. 80
a) 15 15
b) 8 8
c) 12 L 12 R

a) Width of blade in 1/10 mm
b) Length of blade from the centre of angle in mm
c) Angle of blade to its handle in centigrade

CH 10

**Wax and Crown Instruments,
Matrix Instruments**



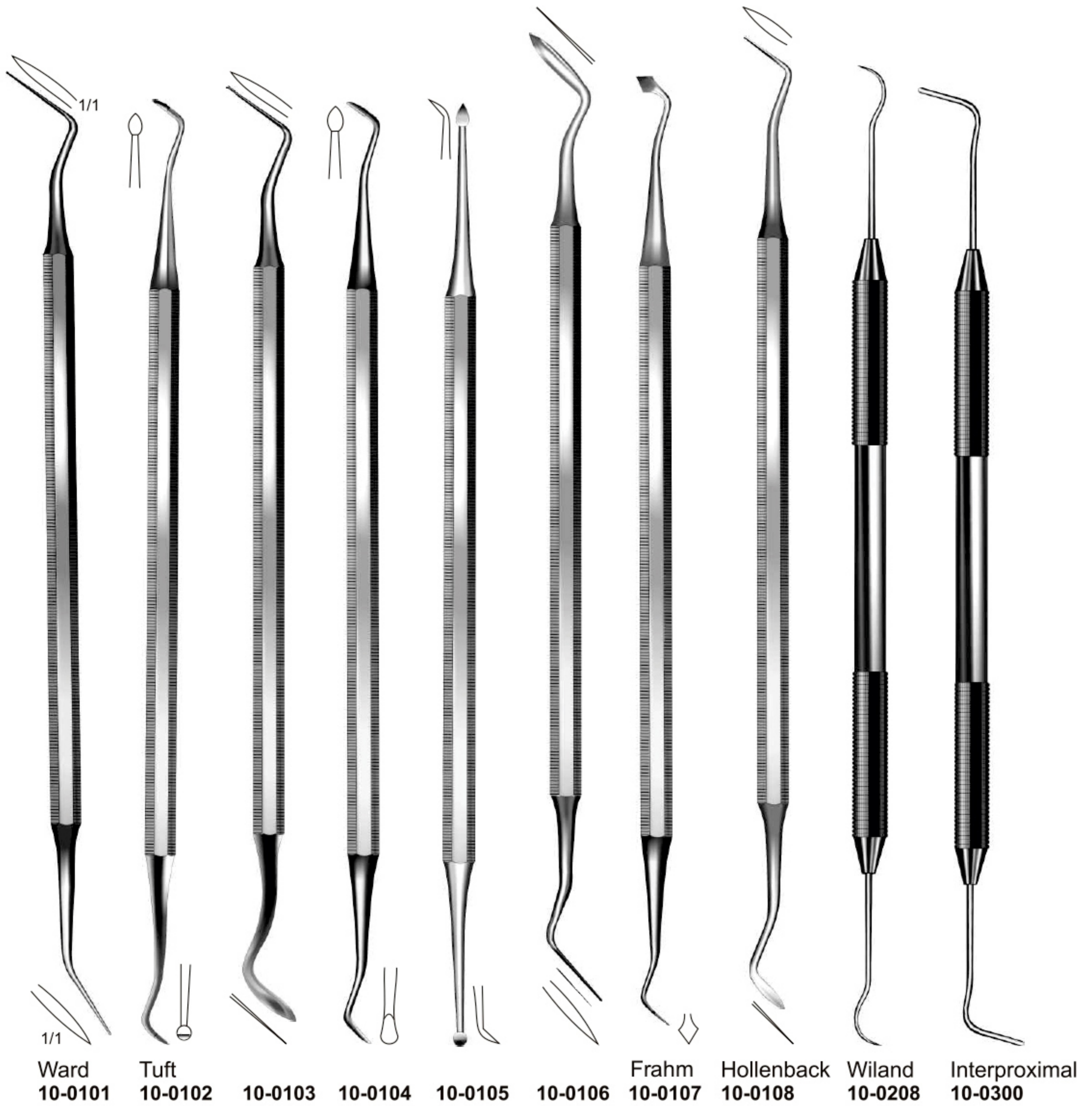

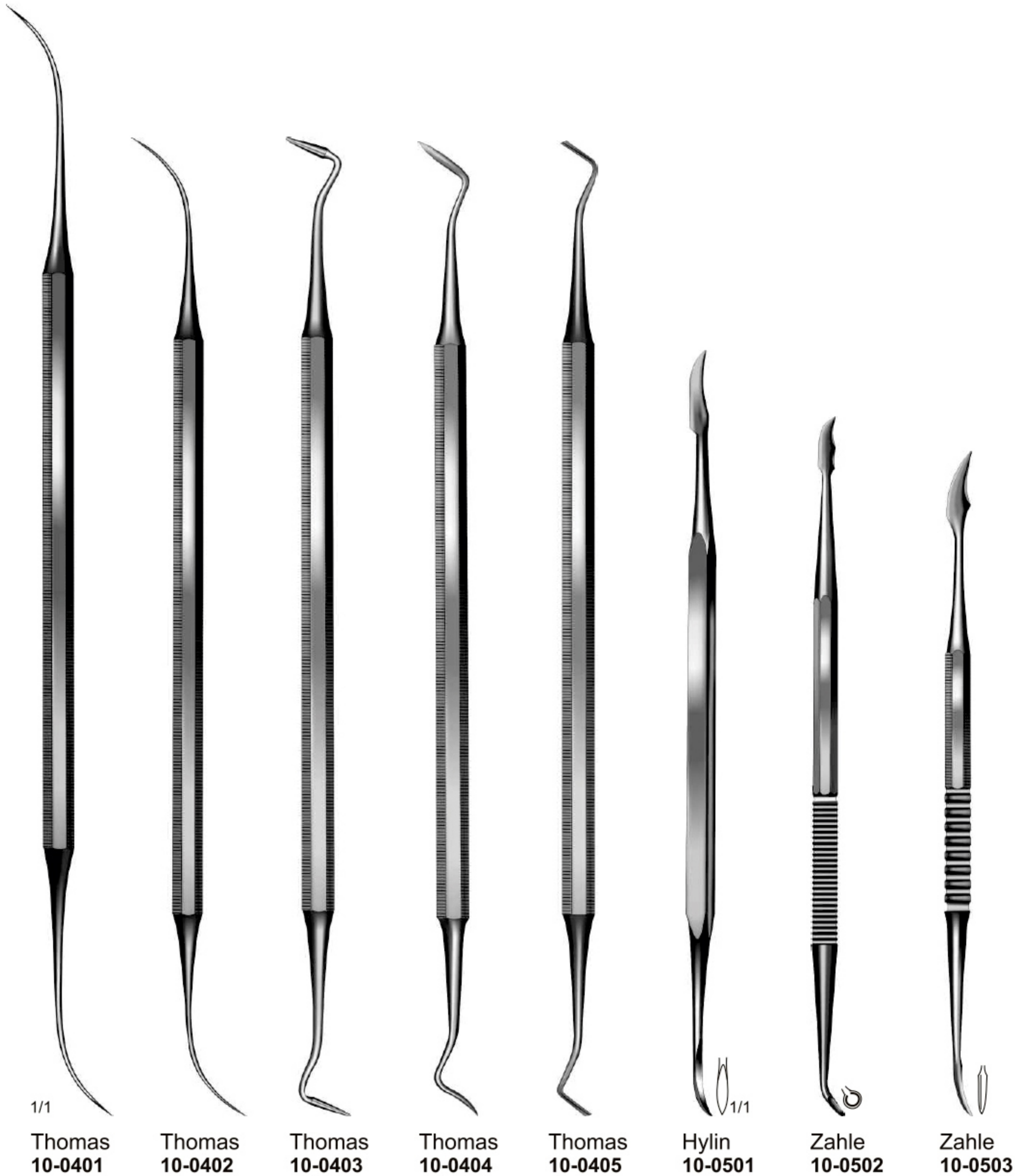

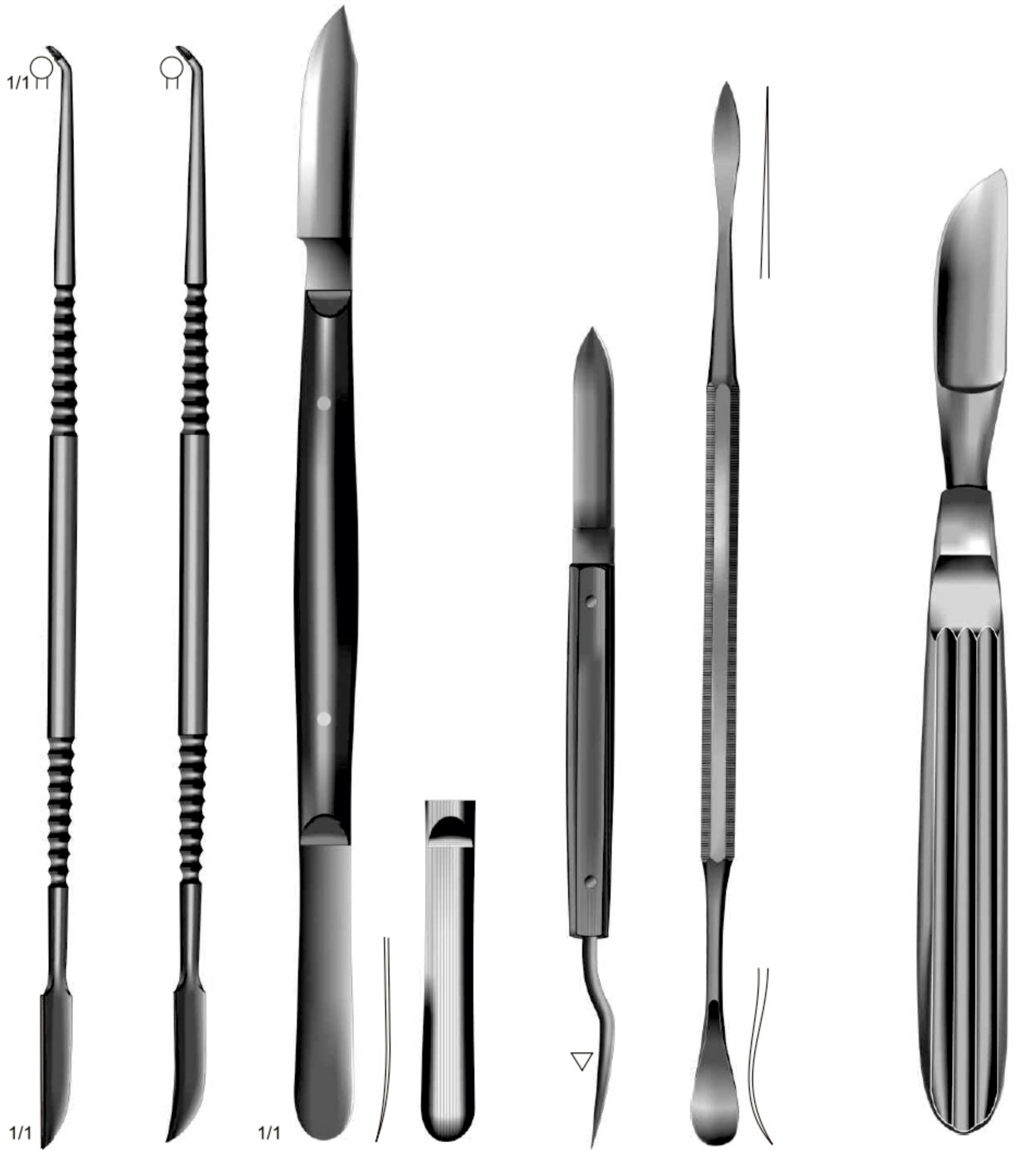

Le Cron
10-0601

Le Cron
10-0602

Fehnenstock
10-0713 - 13 cm/ 5"
10-0717 - 17 cm/ 6 3/4"

Ermert
10-0801

Beale
10-0807

Gisy-Wild
10-0815



Miller
10-0915



Sachs
10-1001



Mershon
10-1101



10-1201



10-1301



10-1302



10-1303



10-1304



10-1305

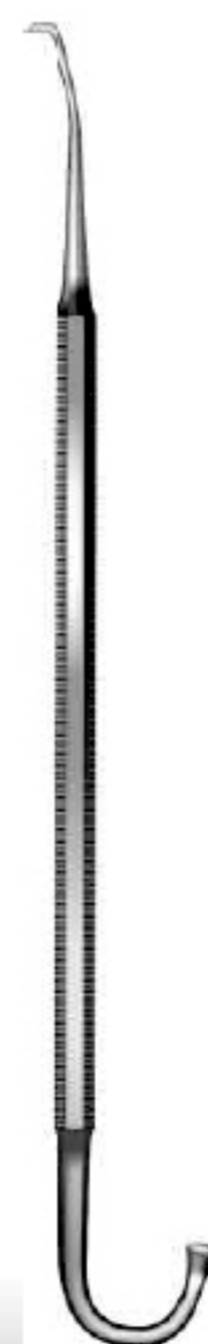

Treyemann
10-1306



Schroeder
10-1300
with interchangeable
points 10-1301-10-1305



10-1307 71



10-1401 - 10-1403



10-1401



10-1402



10-1403



10-1600
(Handle for
10-1600-10-1602)



10-1601



10-1602



Bohm
10-1511
11.5 cm/ 4½"









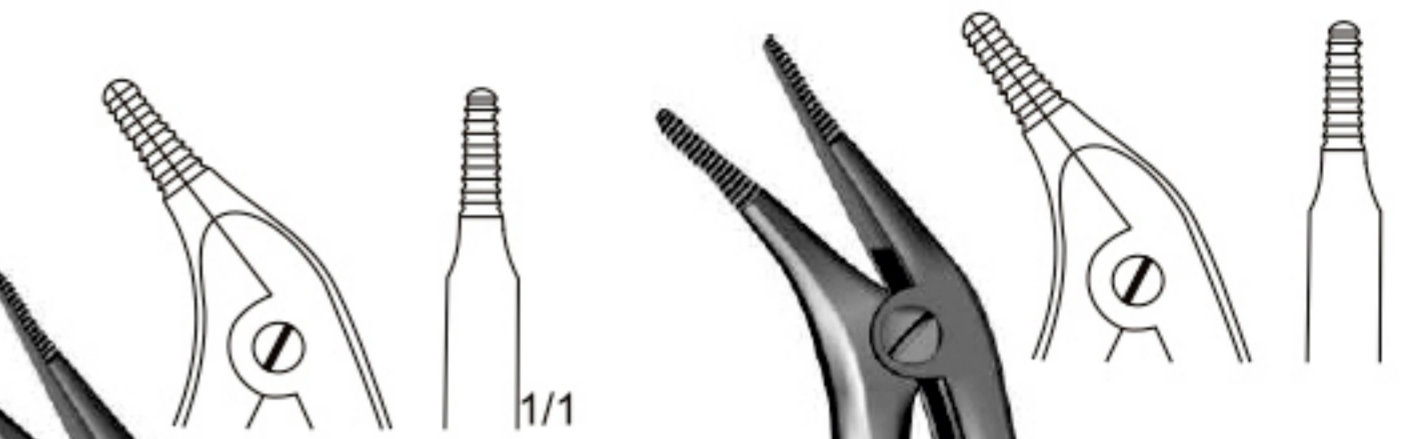





Bohm
10-1514
11.5 cm/ 4½"



10-1800



 <p>1/1 Tofflemire-Universal 10-1905</p>	<p>For Molars</p>  <p>10-1907 Fig. 7</p>  <p>10-1908 Fig. 8</p>  <p>10-1909 Fig. 9</p>  <p>10-1910 Fig. 10</p>	<p>For Molars and Premolars</p>  <p>10-1911 Fig. 1</p>  <p>10-1912 Fig. 12</p>  <p>10-1913 Fig. 13</p>
 <p>1/1 Ivory 10-2005 - 5 mm 10-2006 - 6 mm 10-2007 - 7 mm</p>	<p>(Package of 12 bands)</p>  <p>Tofflemire 10-2101 Fig. 1</p>  <p>Tofflemire 10-2102 Fig. 2</p>	 <p>Tofflemire 10-2103 Fig. 3</p>  <p>Tofflemire 10-2104 Fig. 4</p>

Matrix Retainers, matrix Bands, Rubber Dam Instrum



1/1
Ivory
10-2201
Fig. 1
(Without shield)



Ivory
10-2212
Fig. 12
(With shield)



Ivory
10-2312
Fig. 12 a

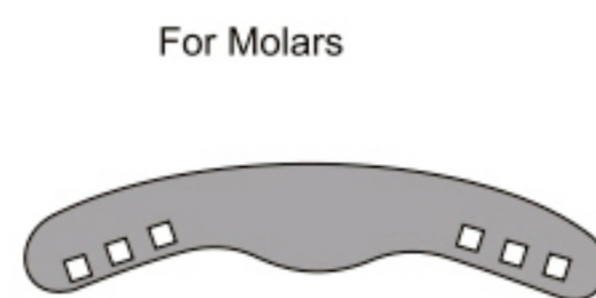

10-2401
Fig. 1



10-2402
Fig. 2



10-2403
Fig. 3

10-2401 - 10-2403

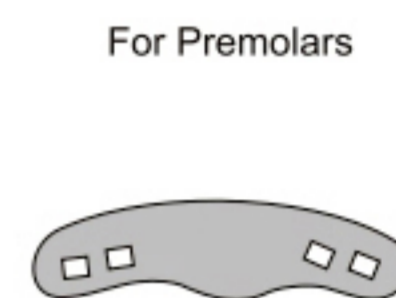

10-2404
Fig. 4



10-2405
Fig. 5



10-2406
Fig. 6

10-2404 - 10-2406



Ainsworth
10-2516
16 cm/6 1/4"



10-2515
15cm/6"



Stockes
10-2617
17 cm/ 6 3/4"



Brewer
10-2717
17 cm/ 6 3/4"

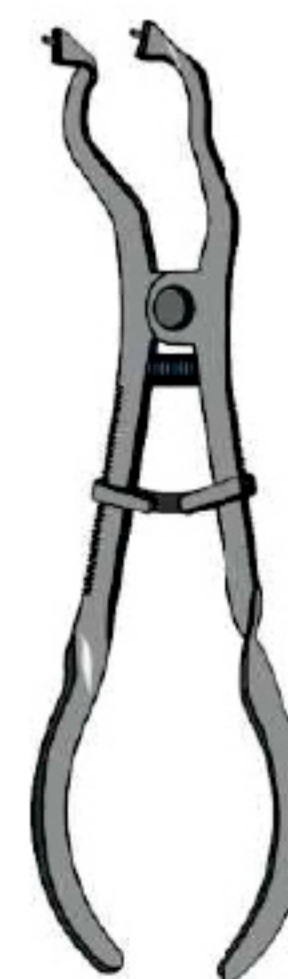

10-2716
16 cm/6 1/4"

CH 11

Impression Trays



Stainless Steel

INOX
18/08

Stainless steel “Solid” impression trays with retention rim.

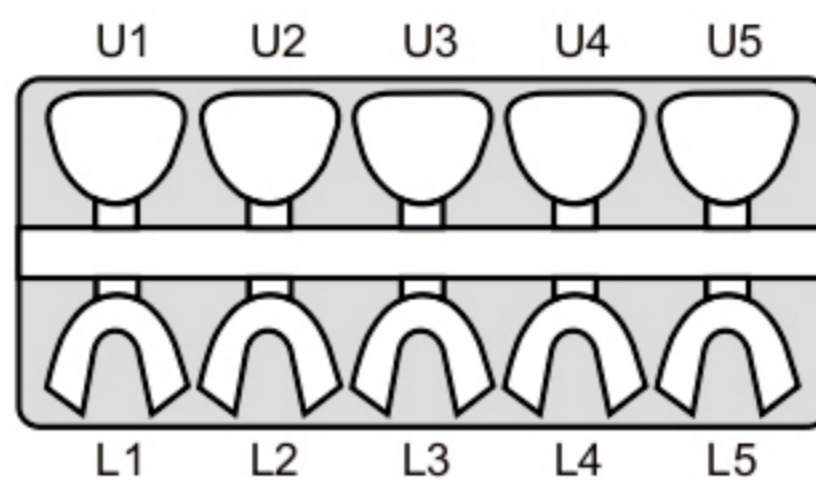

set
10

Set of 10 pieces.
11-2003

For Upper Jaw



		mm.	mm.
11-2051- U1	XL	81	63
11-2052- U2	L	74	60
11-2053- U3	M	71	55
11-2054- U4	NM	67	53
11-2055- U5	S	65	51

For Lower Jaw



		mm.	mm.
11-2061- L1	XL	80	63
11-2062- L2	L	78	59
11-2063- L3	M	76	57
11-2064- L4	NM	72	57
11-2065- L5	S	69	50

Stainless steel “Perforated” impression trays with retention rim.

For Upper Jaw

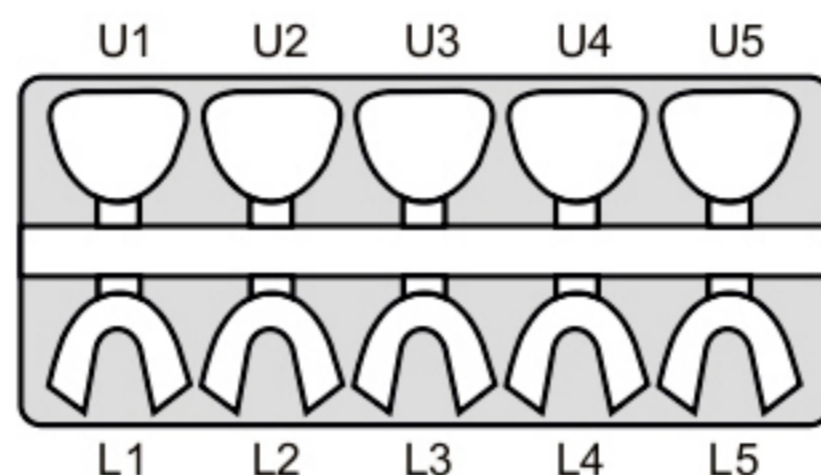

Set of 10 pieces.
11-2103

set
10

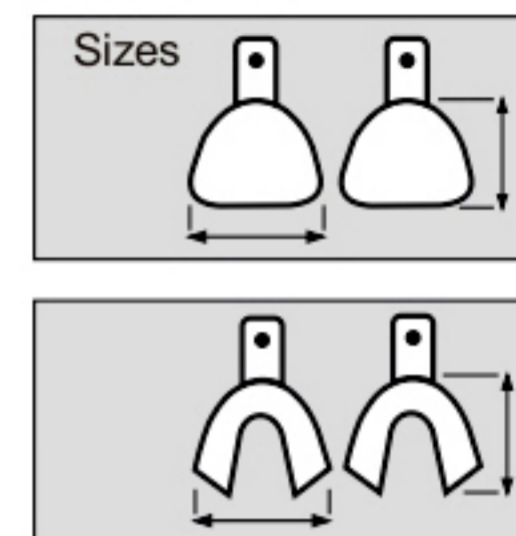

		mm.	mm.
11-2151- U1	XL	81	63
11-2152- U2	L	74	60
11-2153- U3	M	71	55
11-2154- U4	NM	67	53
11-2155- U5	S	65	51

For Lower Jaw



		mm.	mm.
11-2161- L1	XL	80	63
11-2162- L2	L	78	59
11-2163- L3	M	76	57
11-2164- L4	NM	72	57
11-2165- L5	S	69	50

Stainless Steel

INOX
18/08

Stainless steel "Solid" impression trays with retention rim.

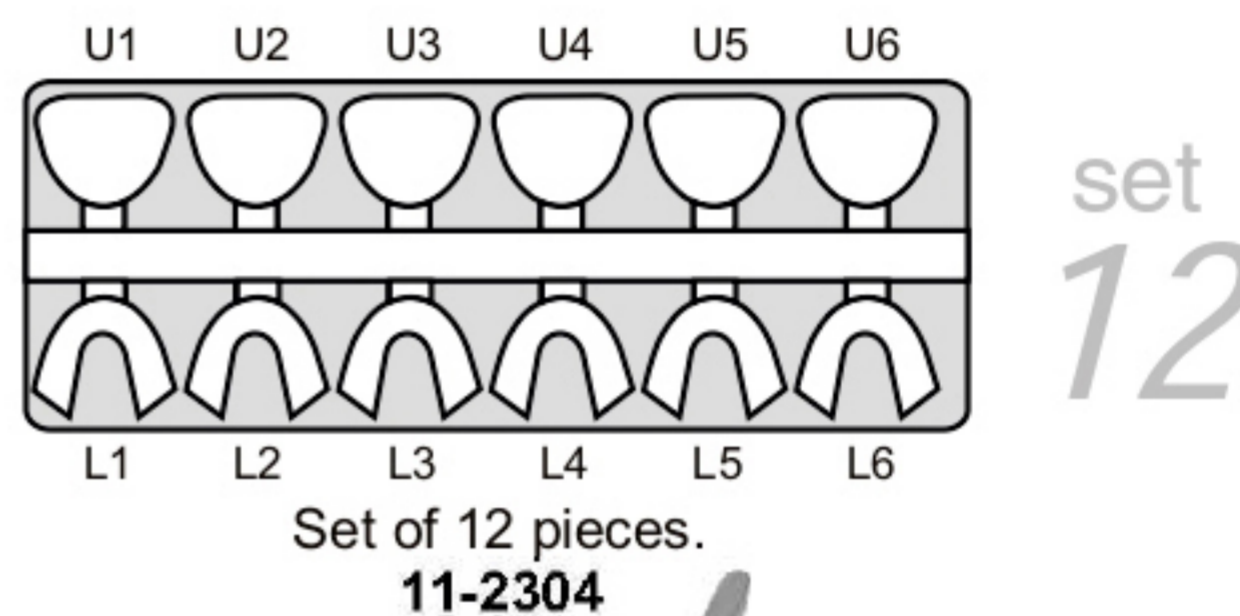
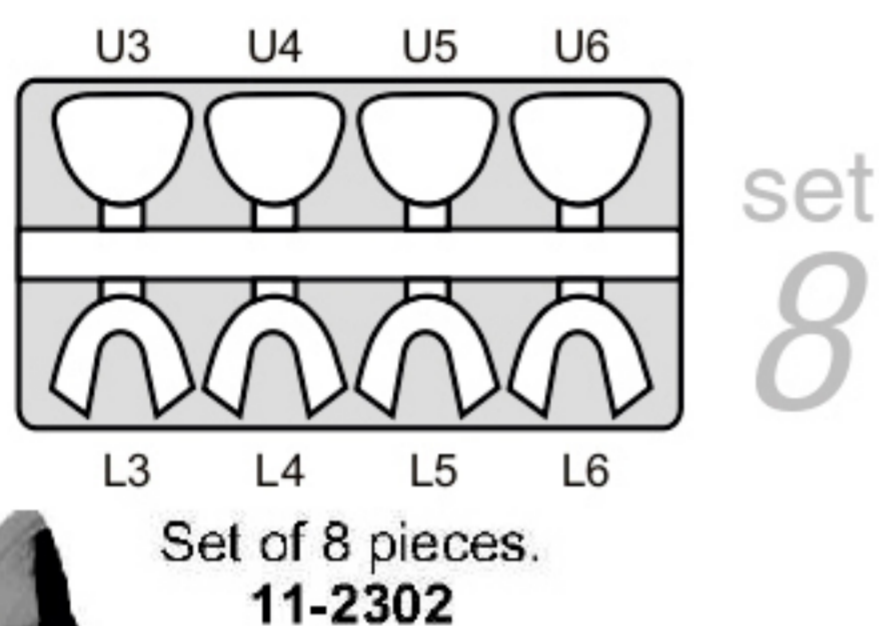
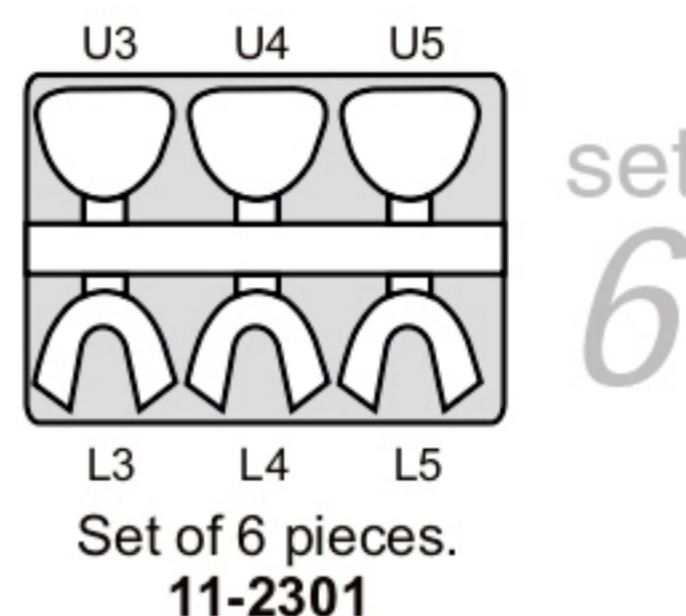

For Upper Jaw

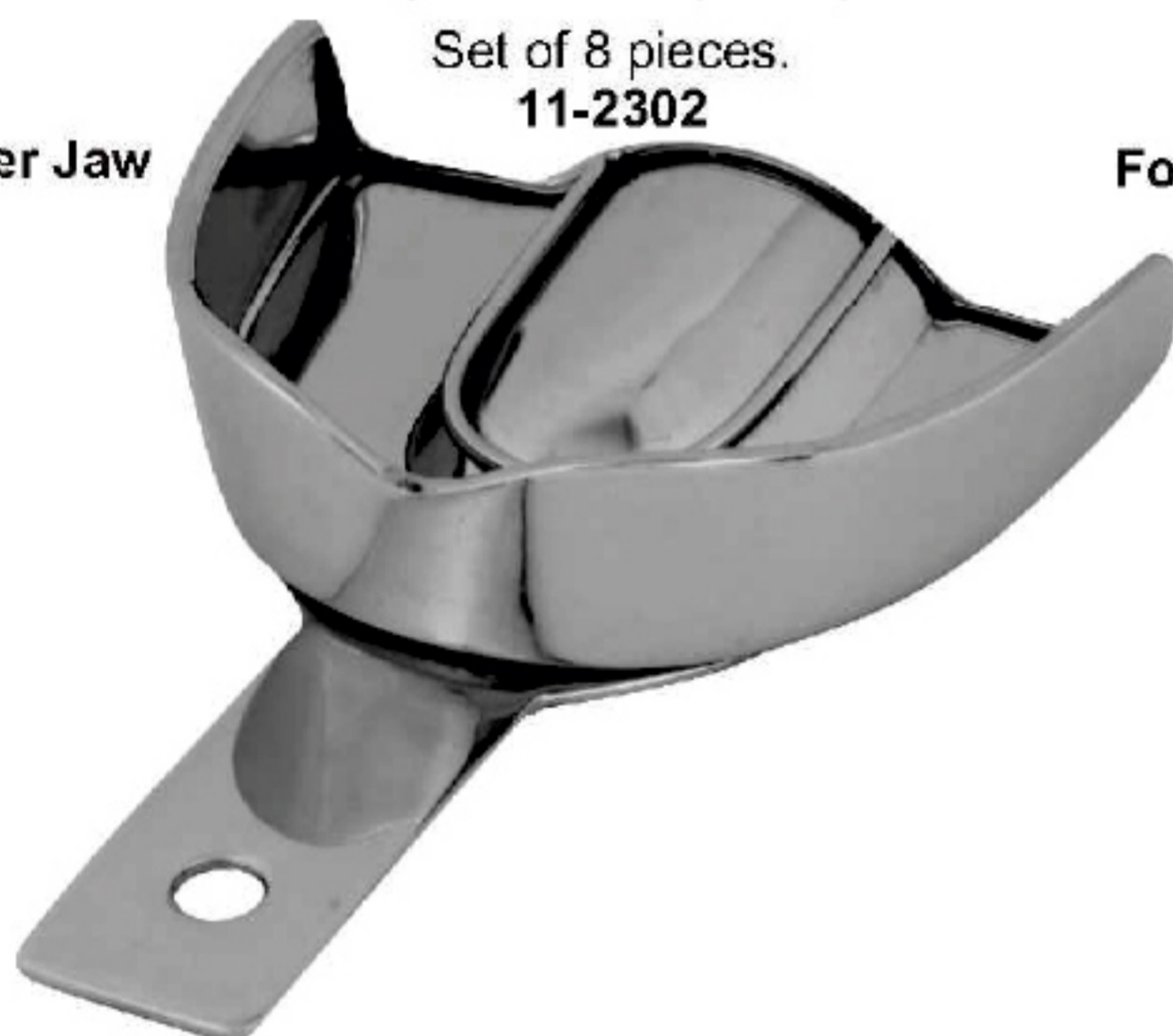

For Lower Jaw



		mm.	mm.
11-2311- U1	XXS	61	47
11-2312- U2	XS	64	51
11-2313- U3	S	66	53
11-2314- U4	M	69	57
11-2315- U5	L	71	60
11-2316- U6	XL	73	62

		mm.	mm.
11-2331- L1	XXS	55	47
11-2332- L2	XS	60	49
11-2333- L3	S	72	54
11-2334- L4	M	74	57
11-2335- L5	L	76	59
11-2336- L6	XL	78	61

Partial impression trays for crown and bridge work.



11-2361- U1P



11-2362- L1P



11-2342- L2D
11-2344- L4D
11-2346- L6D



11-2352- L2S
11-2354- L4S
11-2356- L6S

CH 11

Impression Trays

Stainless steel “Perforated” impression trays with retention rim.

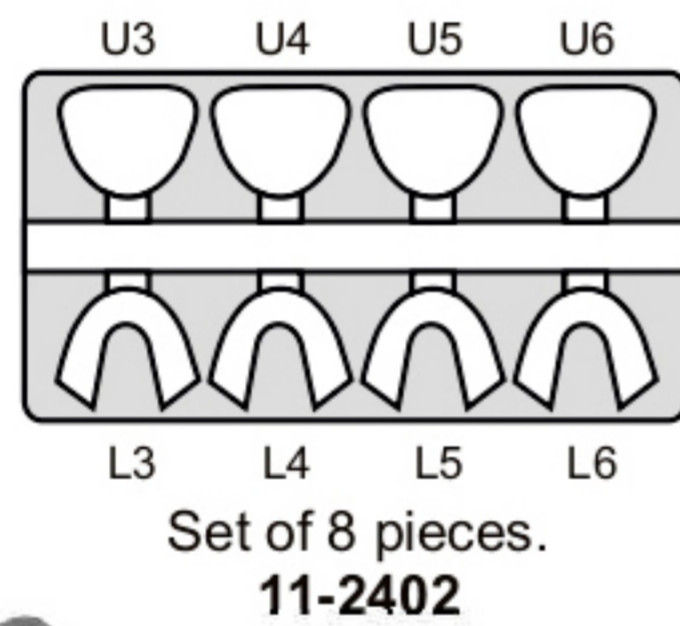
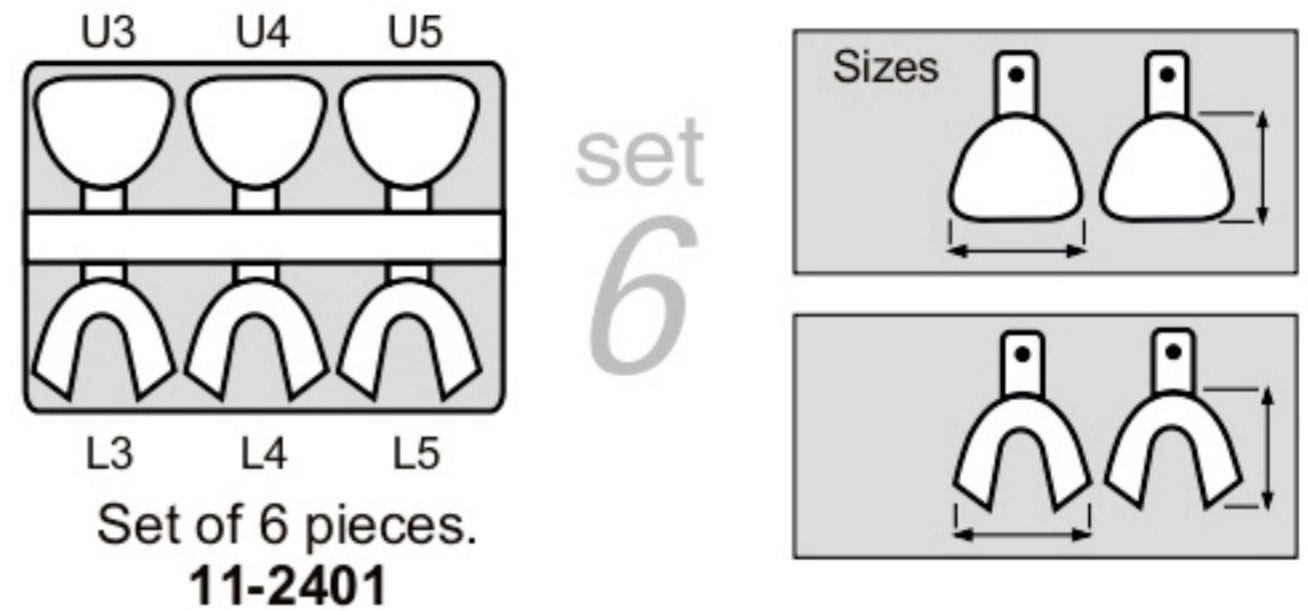

set 8

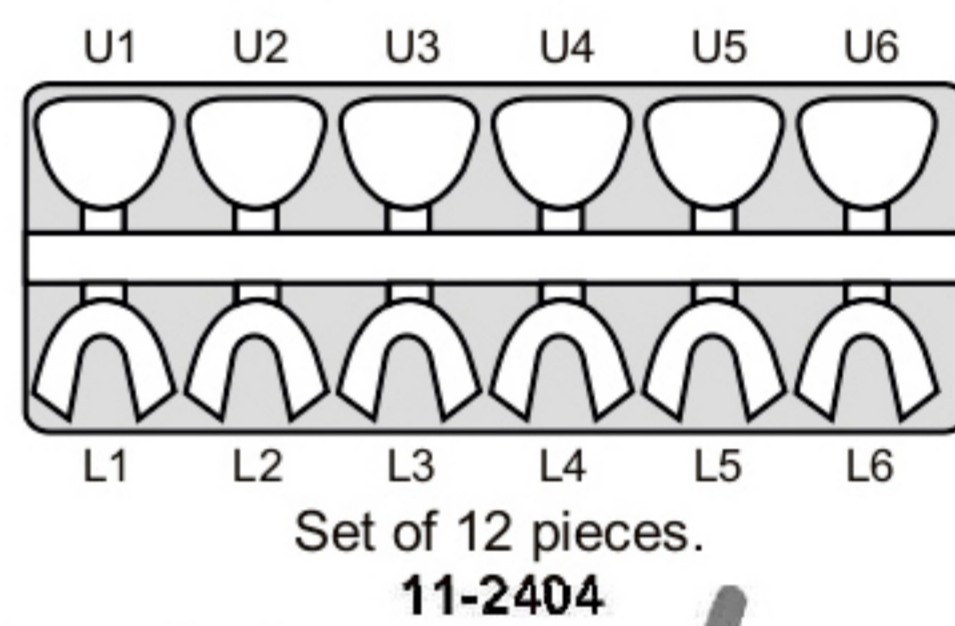

set 12

For Upper Jaw

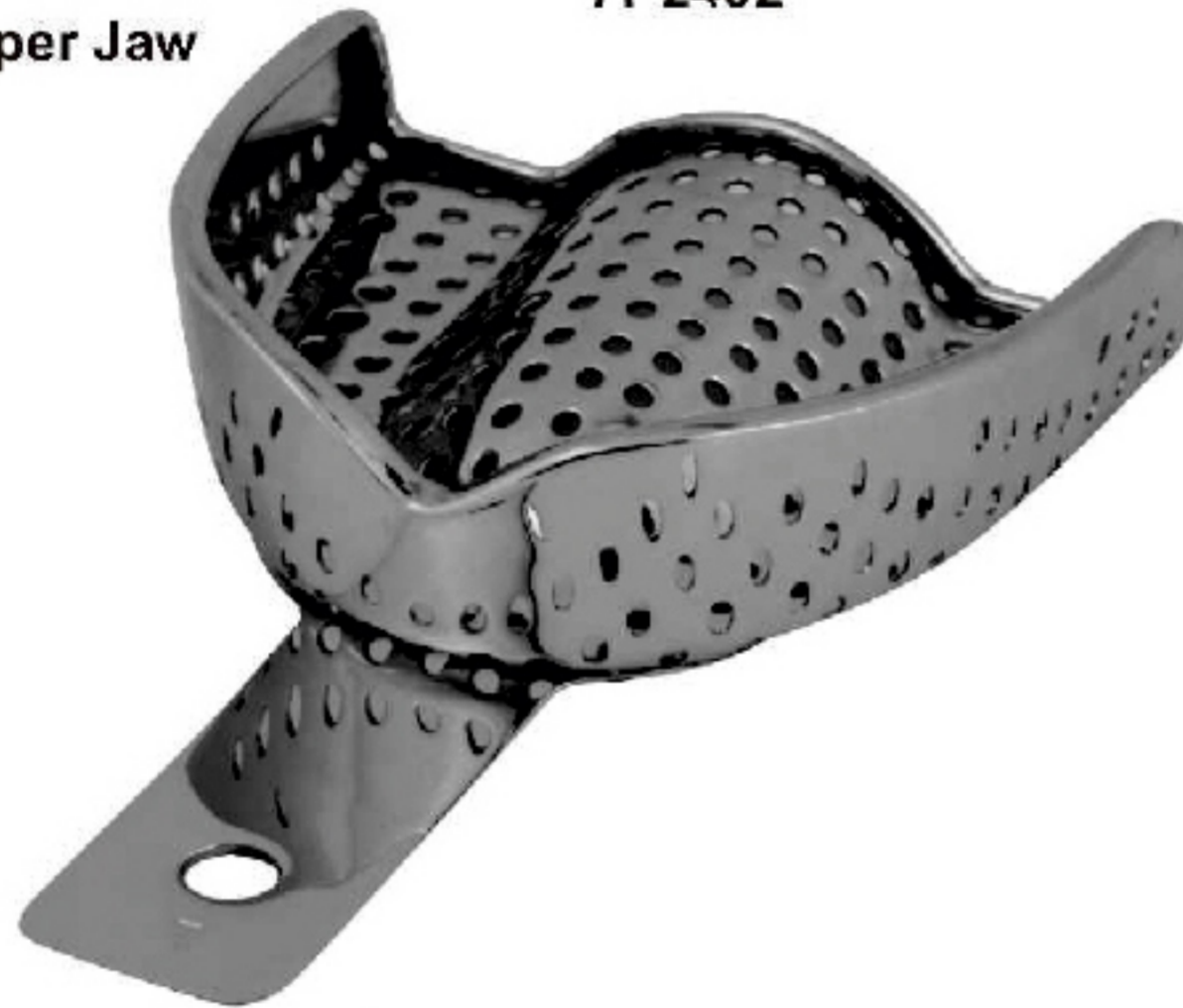

For Lower Jaw



		mm.	mm.
11-2411- U1	XXS	61	47
11-2412- U2	XS	64	51
11-2413- U3	S	66	53
11-2414- U4	M	69	57
11-2415- U5	L	71	60
11-2416- U6	XL	73	62

		mm.	mm.
11-2431- L1	XXS	55	47
11-2432- L2	XS	60	49
11-2433- L3	S	72	54
11-2434- L4	M	74	57
11-2435- L5	L	76	59
11-2436- L6	XL	78	61

Partial impression trays for crown and bridge work.



11-2461- U1P



11-2462- L1P



11-2442- L2D
11-2444- L4D
11-2446- L6D



11-2452- L2S
11-2454- L4S
11-2456- L6S

Stainless Steel

INOX
18/08

Anteriorly depressed with retention rim.
Stainless Steel "Solid"

"Solid" stainless steel

For Upper Jaw

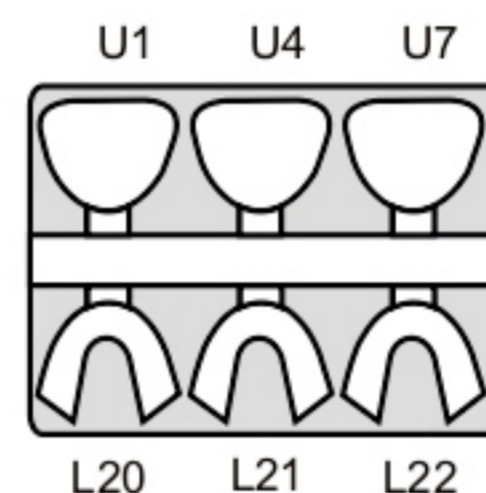

set
6

Set of 6 pieces.
11-2601

		mm.	mm.
11-2611- U1	L	81	67
11-2614- U4	M	71	64
11-2617- U7	S	70	57

For Lower Jaw



		mm.	mm.
11-2631- L20	L	81	60
11-2634- L21	M	79	57
11-2637- L22	S	76	54

Anteriorly depressed with retention rim.
Stainless steel "Perforated"

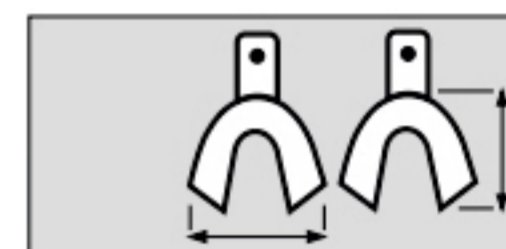
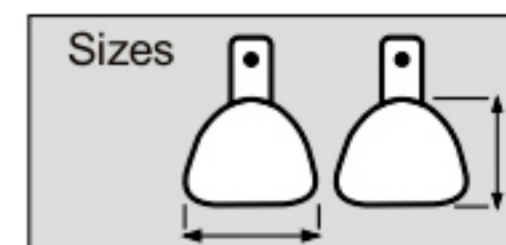

"Perforated" stainless steel

For Upper Jaw

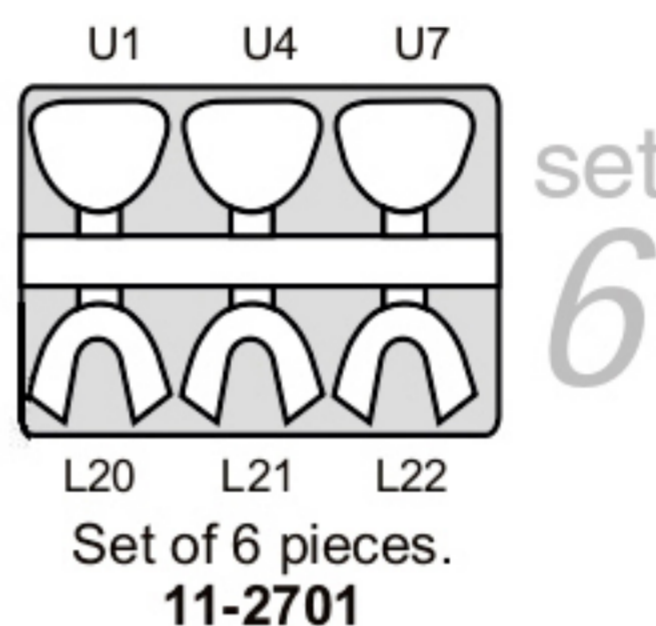
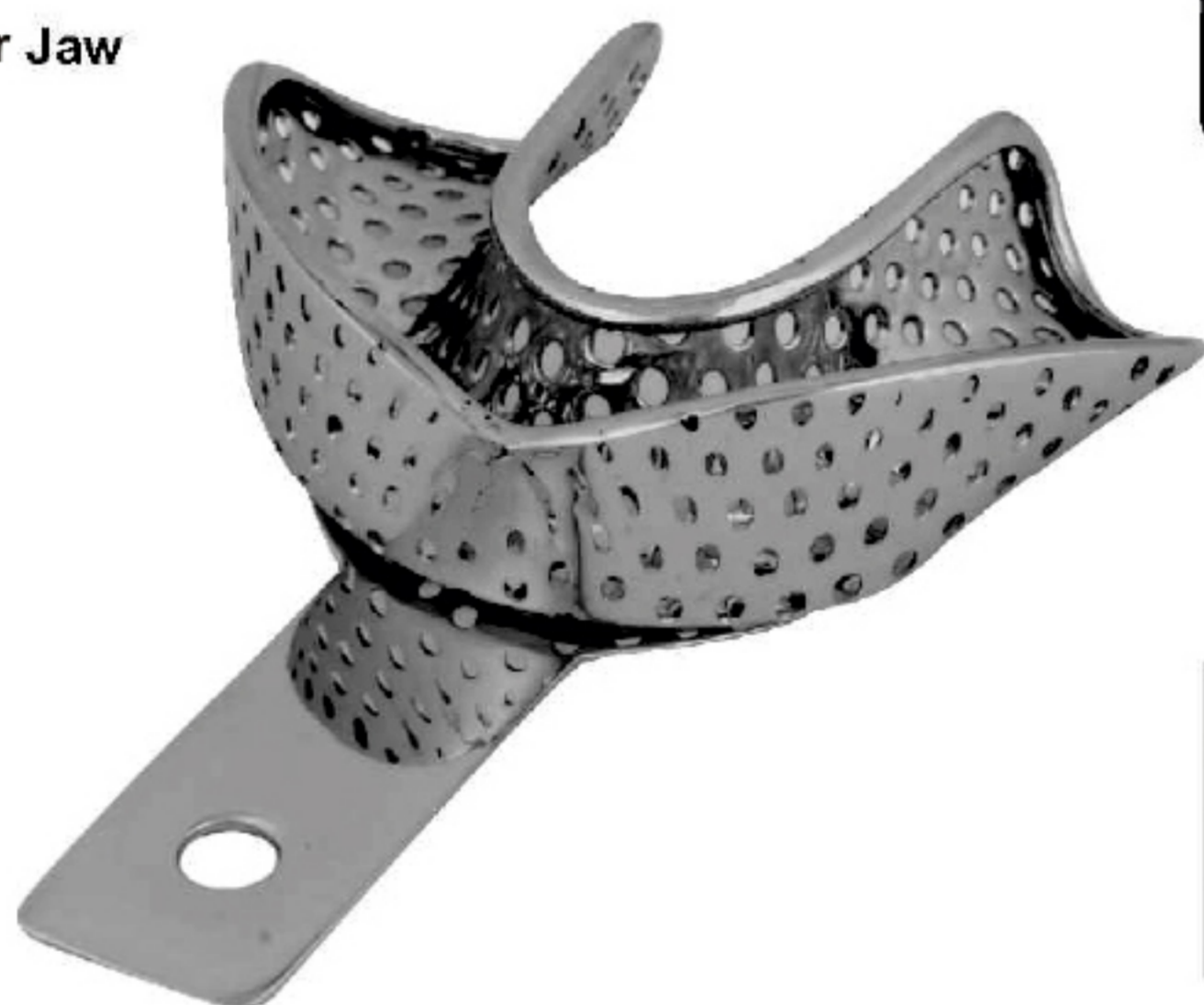

		mm.	mm.
11-2711- U1	L	81	67
11-2714- U4	M	71	64
11-2717- U7	S	70	57

For Lower Jaw

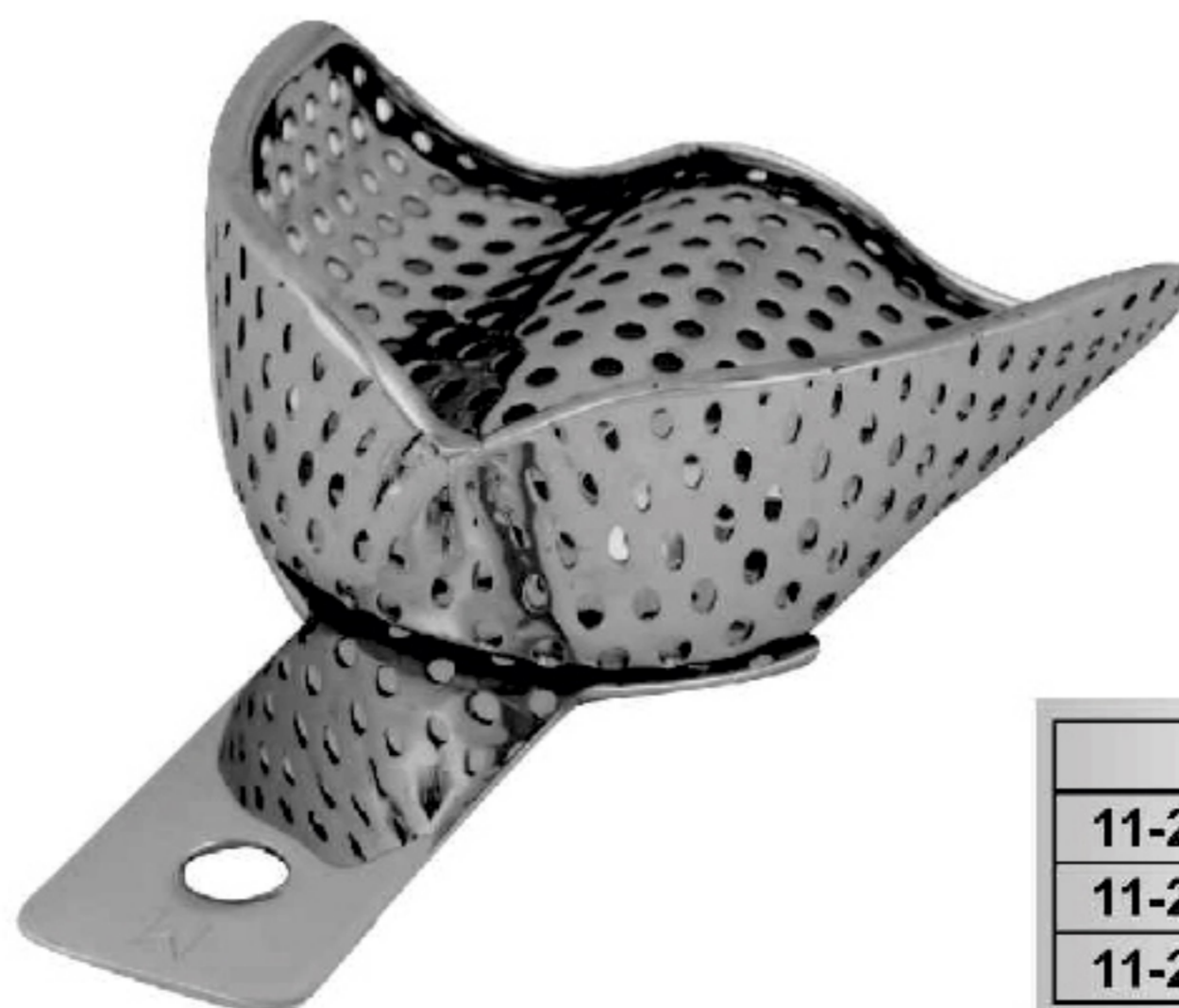

		mm.	mm.
11-2731- L20	L	81	60
11-2734- L21	M	79	57
11-2737- L22	S	76	54

Stainless Steel

INOX
18/08

Stainless steel "Solid" impression trays without retention rim.

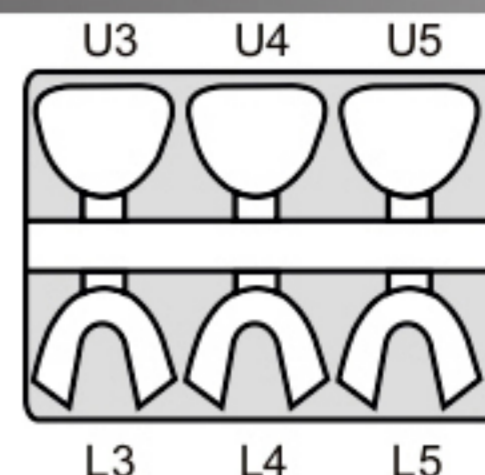

set
6

Set of 6 pieces.
11-2901

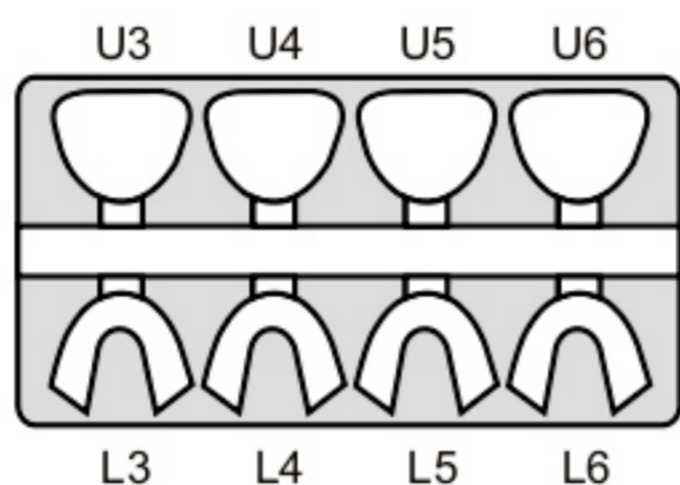

set
8

Set of 8 pieces.
11-2902

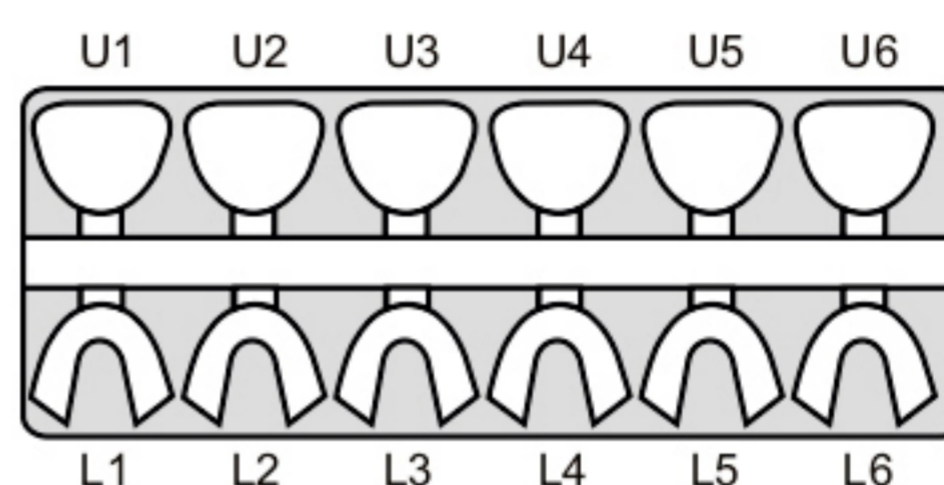

set
12

Set of 12 pieces.
11-2904

For Upper Jaw

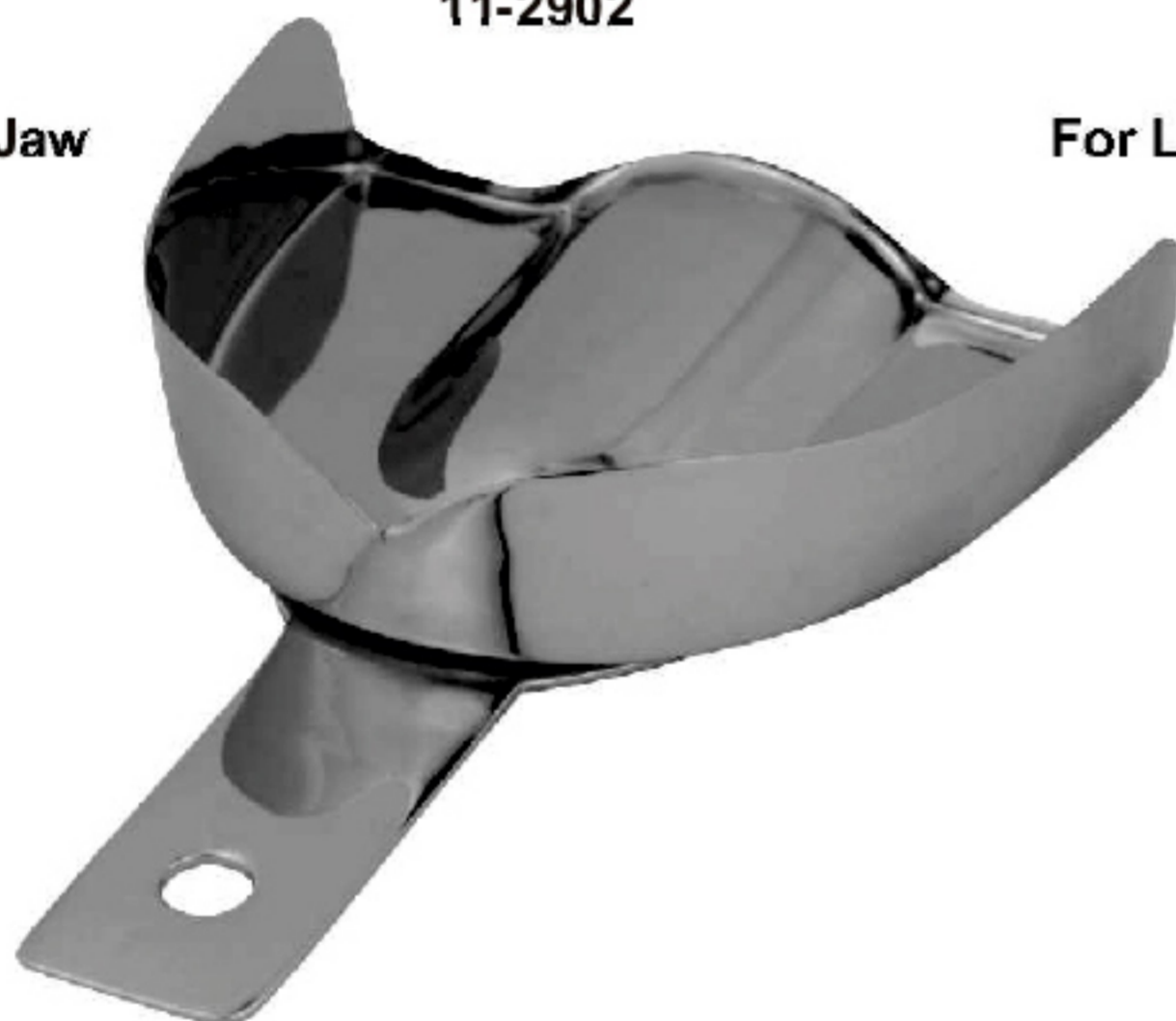

For Lower Jaw



		mm.	mm.
11-2911- U1	XXS	61	47
11-2912- U2	XS	64	51
11-2913- U3	S	66	53
11-2914- U4	M	69	57
11-2915- U5	L	71	60
11-2916- U6	XL	73	62

		mm.	mm.
11-2931- L1	XXS	55	47
11-2932- L2	XS	60	49
11-2933- L3	S	72	54
11-2934- L4	M	74	57
11-2935- L5	L	76	59
11-2936- L6	XL	78	61

Partial impression trays for crown and bridge work.



11-2942- L2D
11-2944- L4D
11-2946- L6D



11-2952- L2S
11-2954- L4S
11-2956- L6S

**Stainless steel “Perforated”
impression trays without
retention rim.**

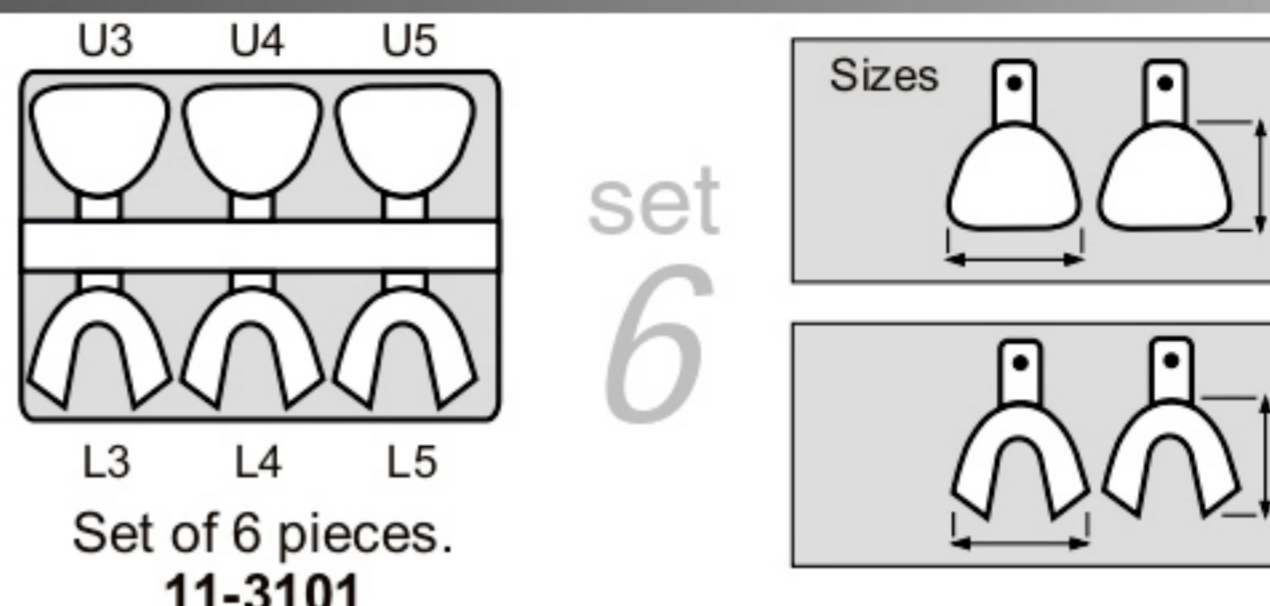

set
6

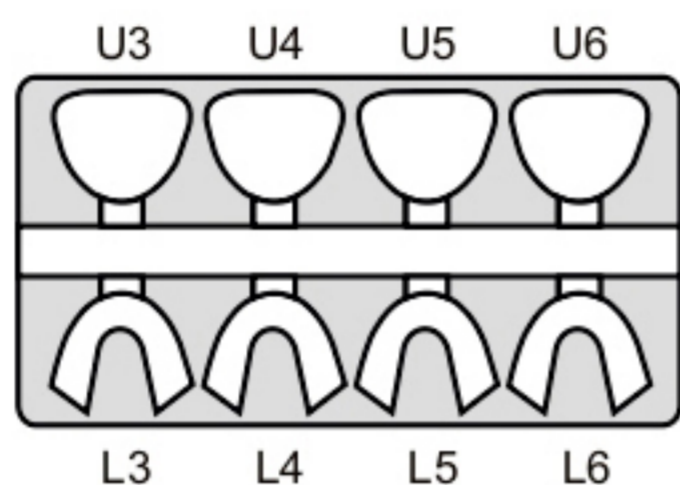

Set of 8 pieces.
11-3102

set
8

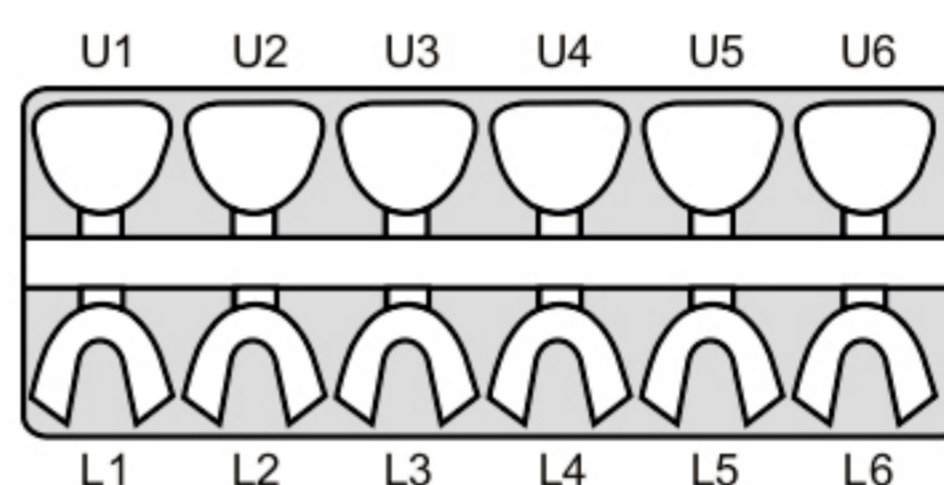

Set of 12 pieces.
11-3104

set
12

For Upper Jaw

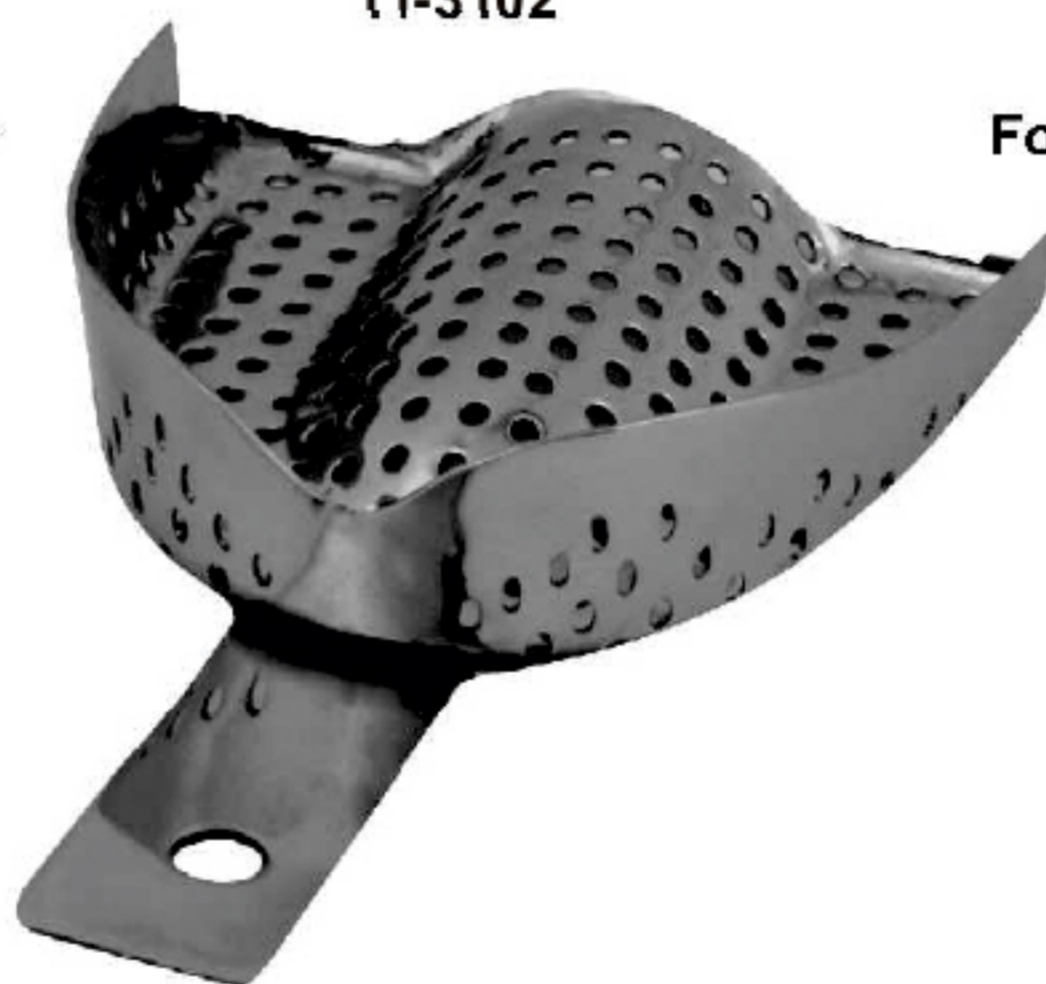

For Lower Jaw

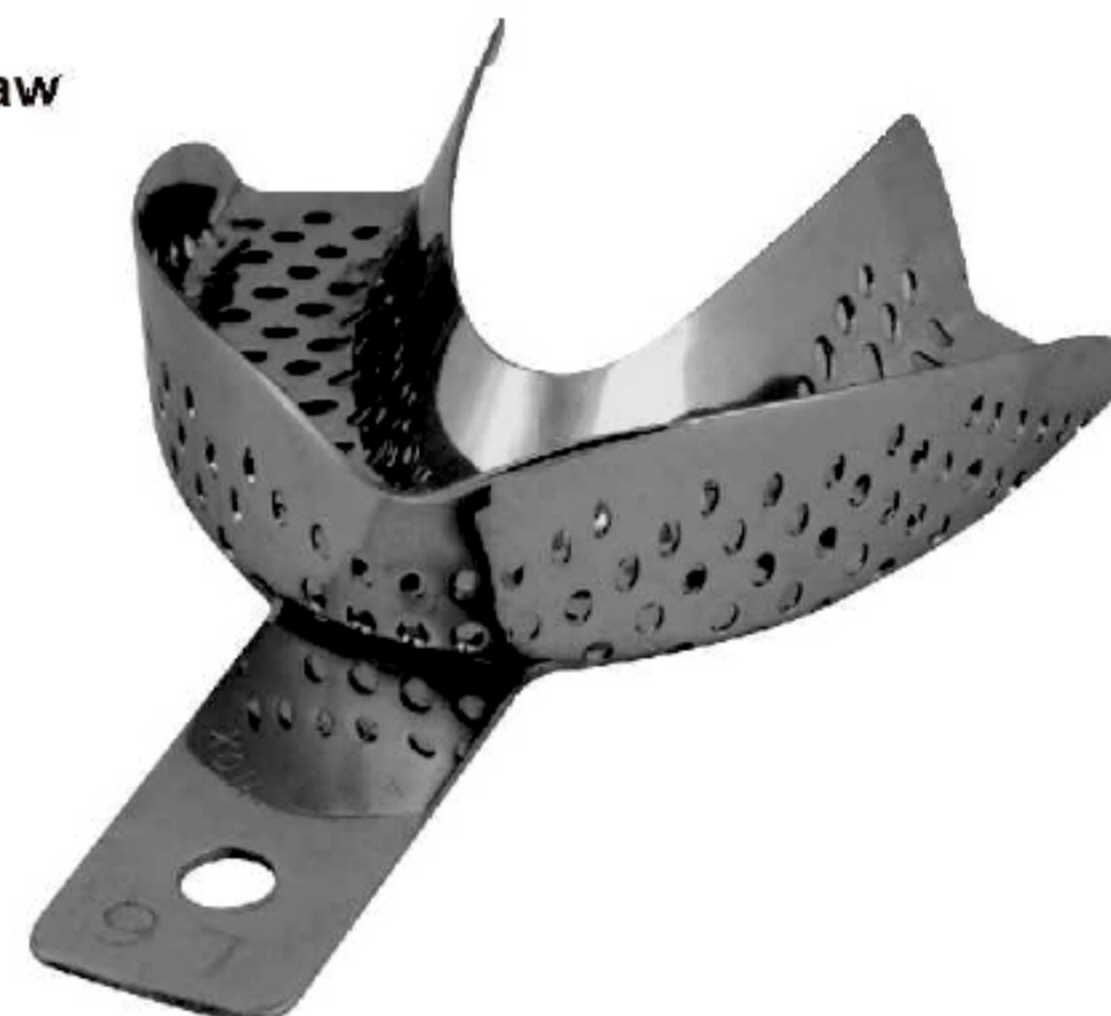

		mm.	mm.
11-3111- U1	XXS	61	47
11-3112- U2	XS	64	51
11-3113- U3	S	66	53
11-3114- U4	M	69	57
11-3115- U5	L	71	60
11-3116- U6	XL	73	62

		mm.	mm.
11-3131- L1	XXS	55	47
11-3132- L2	XS	60	49
11-3133- L3	S	72	54
11-3134- L4	M	74	57
11-3135- L5	L	76	59
11-3136- L6	XL	78	61

**Partial impression trays for crown
and bridge work.**



11-3142- L2D
11-3144- L4D
11-3146- L6D



11-3152- L2S
11-3154- L4S
11-3156- L6S

EHRICKE Stainless steel impression trays.

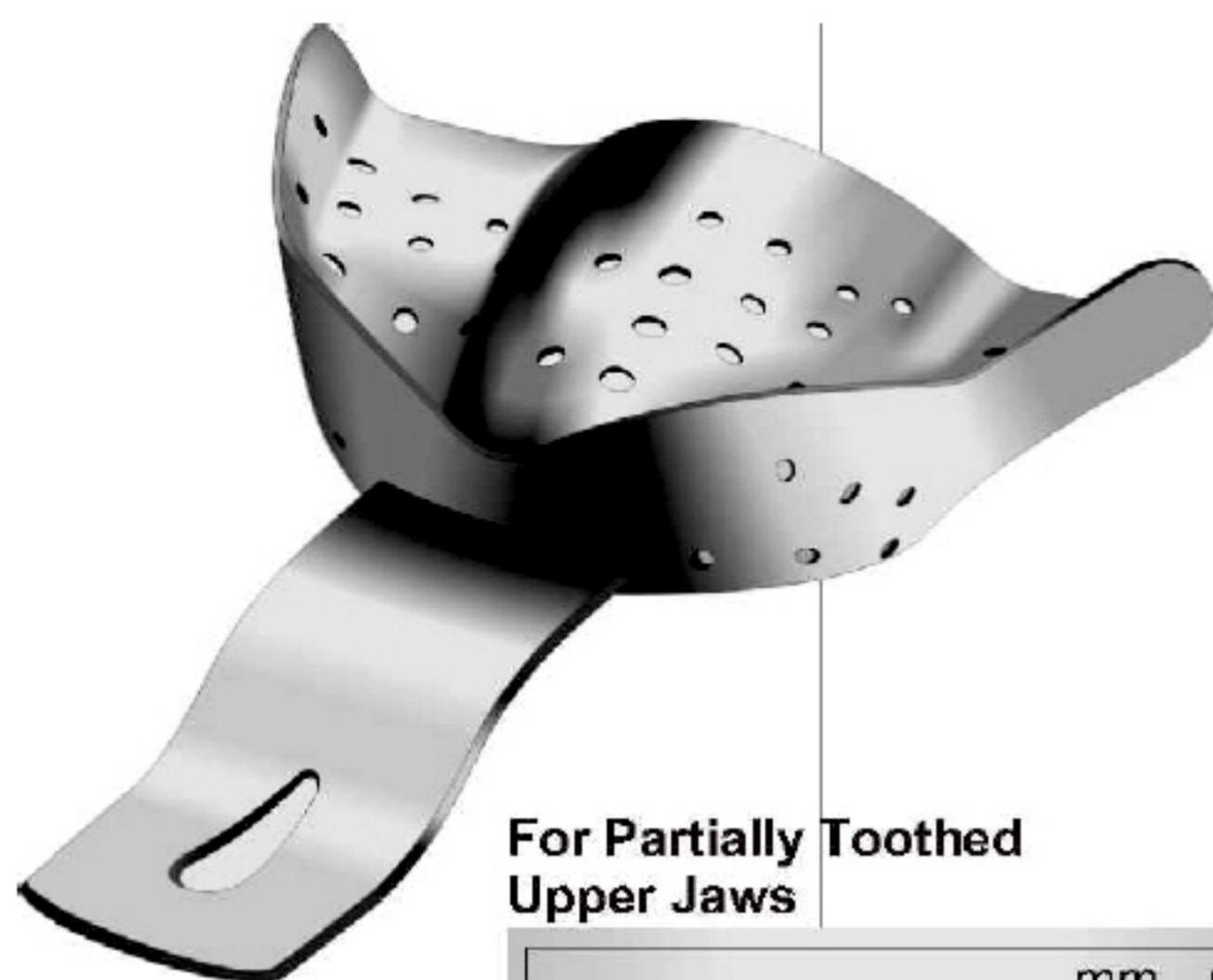
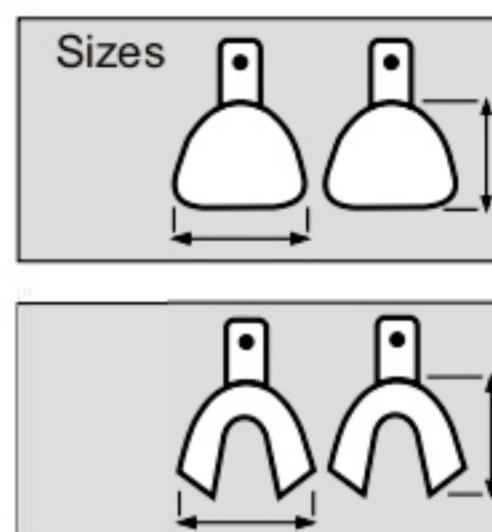

For Partially Toothed Upper Jaws

	mm.	mm.
11-3711- OP1	62	50
11-3712- OP2	70	56

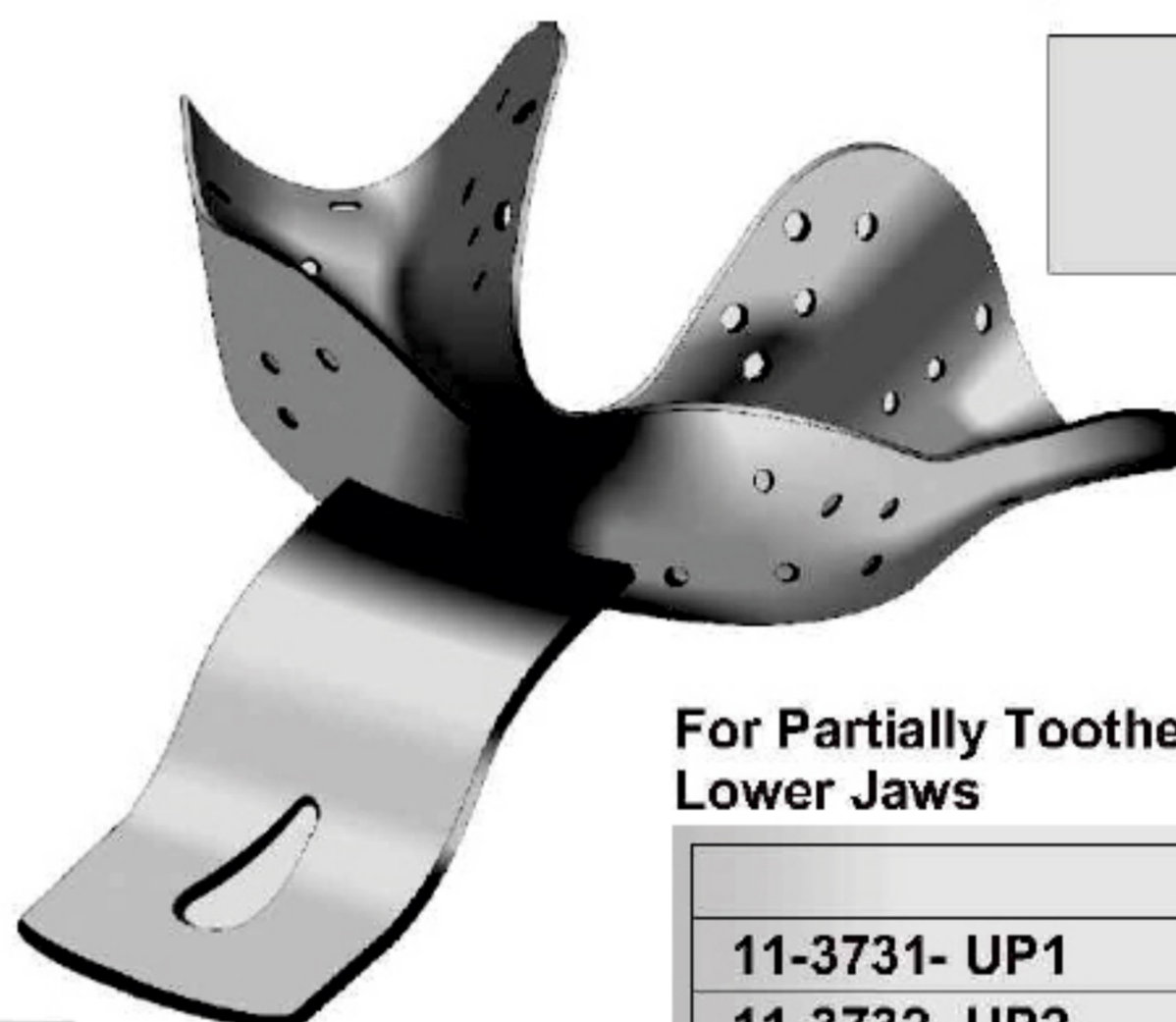

For Partially Toothed Lower Jaws

	mm.	mm.
11-3731- UP1	70	55
11-3732- UP2	78	59



For Edentulous Upper Jaw

	mm.	mm.
11-3811- OU1	64	46
11-3814- OU2	68	53
11-3817- OU3	79	61



For Edentulous Lower Jaw

	mm.	mm.
11-3831- UU1	70	48
11-3834- UU2	70	53
11-3837- UU3	72	57

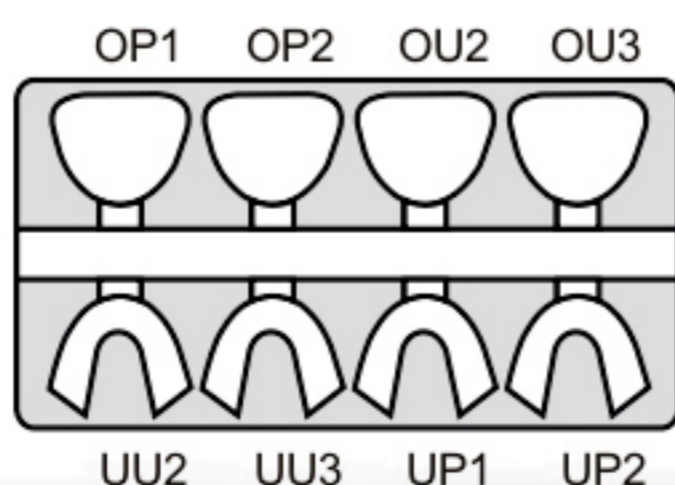

set
8

Set of 8 pieces.
11-3702

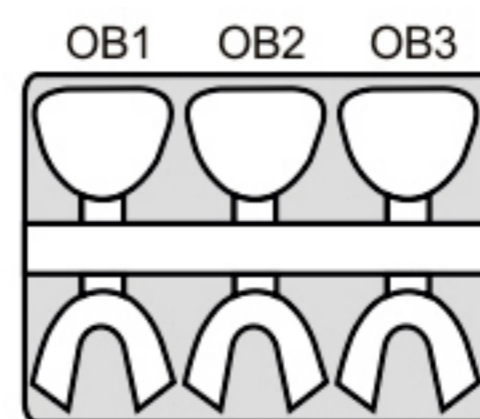

set
6

Set of 6 pieces.
11-3801

CH 12



Pliers For Orthodontics



End and Side Nippers



Wire, Arch and clasp bending pliers

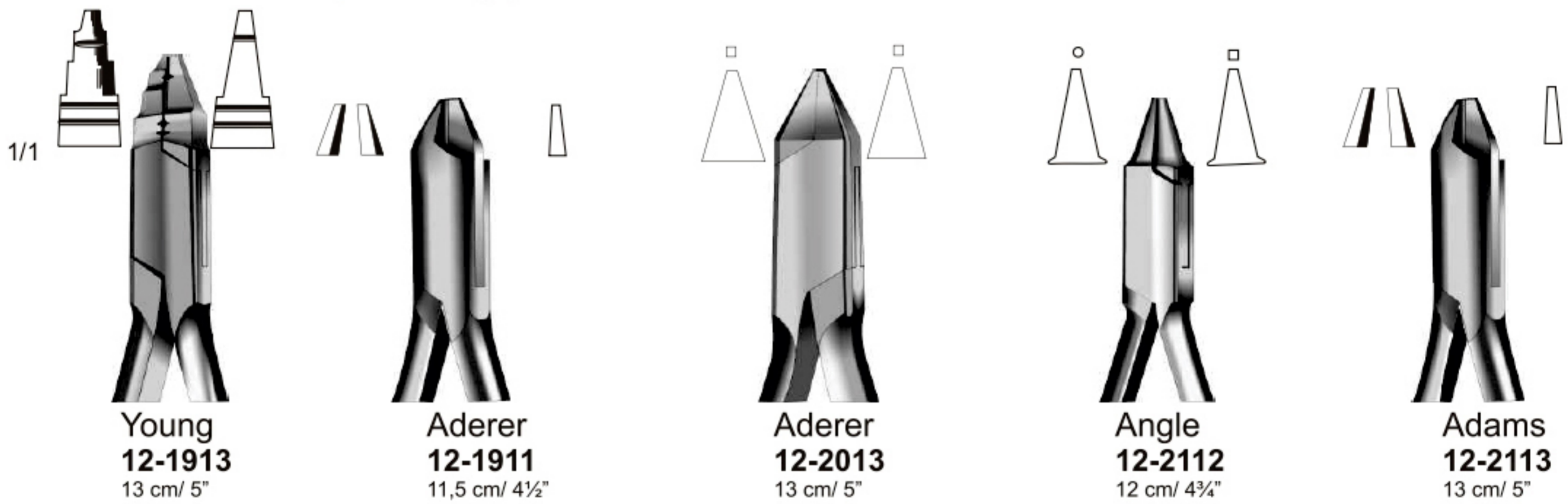

Crown Pliers, Contouring Pliers

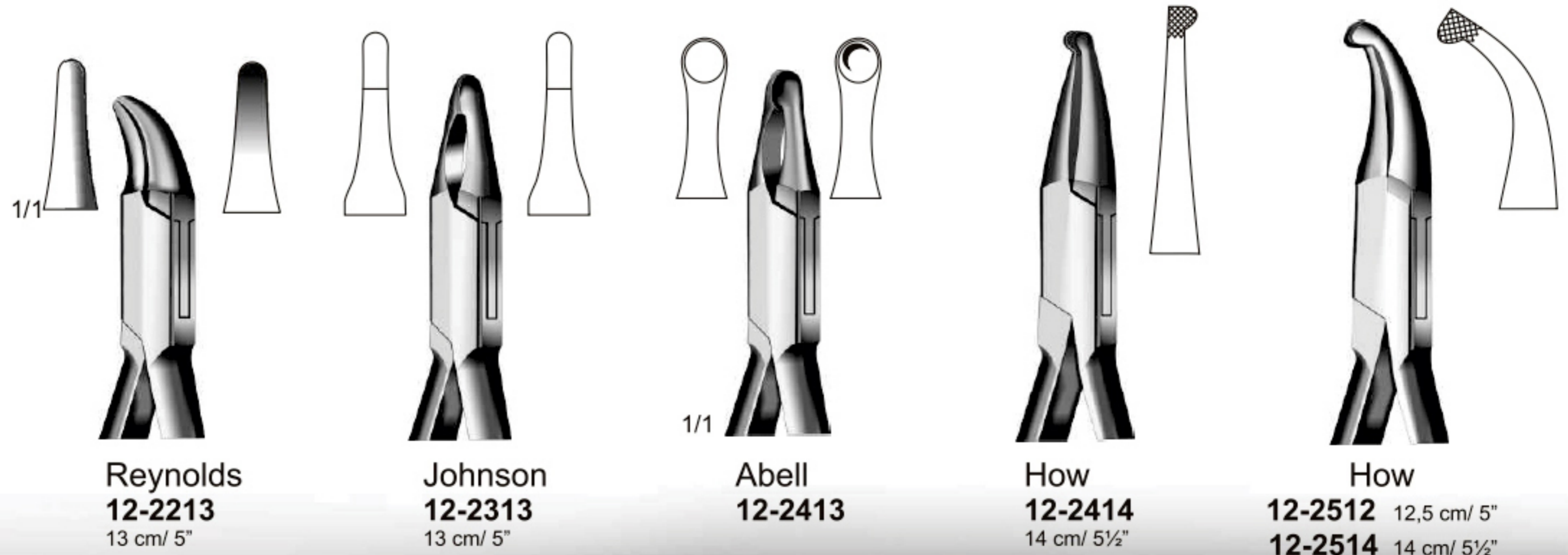

Universal Pliers, Copper Ring and Bridge Removing Pliers



Waldsachs-Universal
12-2615
15,5 cm/ 5"

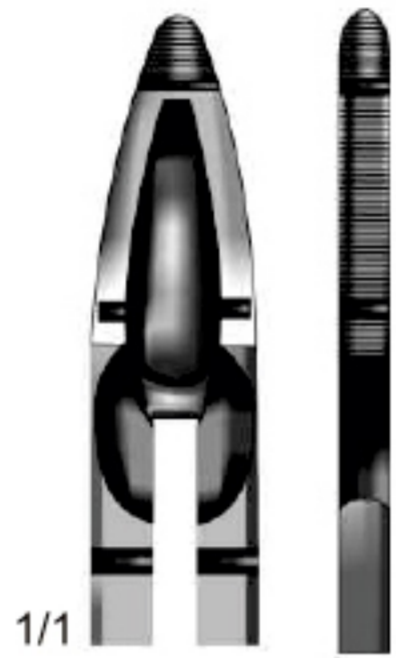

1/1



Universal
12-2715
15,5 cm/ 5"

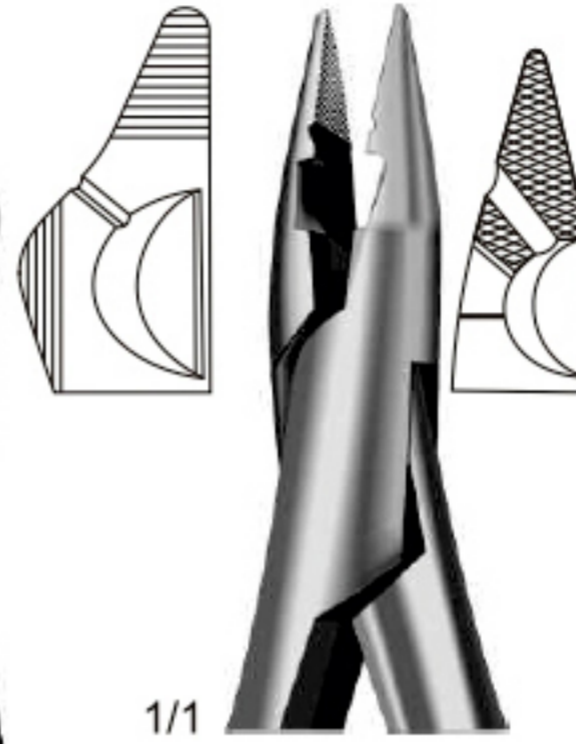

1/1

12-2815
15,5 cm/ 5"



Furrer
12-2915
15,5 cm/ 5"



Lodo
12-3015
15 cm/ 5"

Band Seating & Arch Bending Pliers



12-3013
13 cm/ 5¼"



Lingual Arch Plier
12-3112
11.5 cm/ 4¼"
Designed to form double and triple bends in either .030" (0.76 mm) or .036" (0.91 mm) wire for inserting lingual sheaths



12-3212
12 cm/ 4¾"



12-3213
13 cm/ 5"

Remover



De La Rosa
12-3312
11.5 cm/ 4½"
Arch Forming & Contouring Plier
With three grooves, for wires .016" (0.41 mm), 0.81" (0.46 mm) and .022" (0.56 mm).



De La Rosa
12-3412
11.5 cm/ 4½"
Arch Forming Plier,
without grooves
Same Plier but
without grooves



D.B. Bracket Removing Plier
12-3512 T/C
12 cm/ 4¾"
Useful for ceramic and stainless steel brackets. The tips wedge between edge of bracket and tooth surface and remove it with ease.

Remover



12-3612 T/C
12 cm/ 4¾"

Remover

Bond Bracket



12-3712 T/C
12 cm/ 4¾"



12-3812 T/C
12 cm/ 4¾"



12-3912 T/C
12 cm/ 4¾"



D.B. Bracket Removing Plier, with Pad
12-4012 T/C
12 cm/ 4¾"
Designed for quick and comfortable removal of direct bond brackets. It will also remove adhesive from the tooth.



Posterior Band Removing Plier, Long
12-4112 T/C
12 cm/ 4¾"
Will remove band with maximum patient comfort. The tip is postured in the middle of the pad for band removal ease. A plastic padded tip and a sharp removing beak allow, with a slight pressure, easy band removal.

Wire Bending Pliers

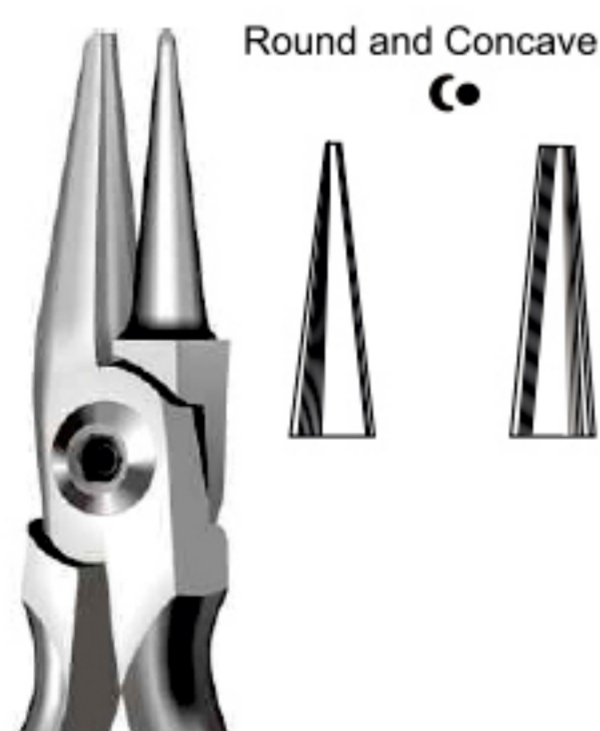

12-4212
12 cm/ 4¾"
Medium Wire Plier,
Round & Concave Plier
For wires up to .28" (0.71 mm)

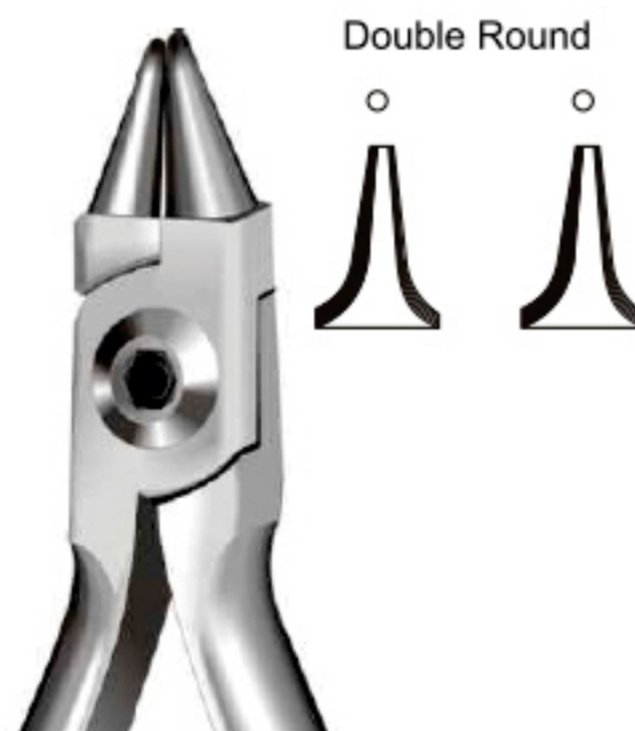

12-4312
11.5 cm/ 4½"
Double Rounded Jaw Plier
For wires up to .030".

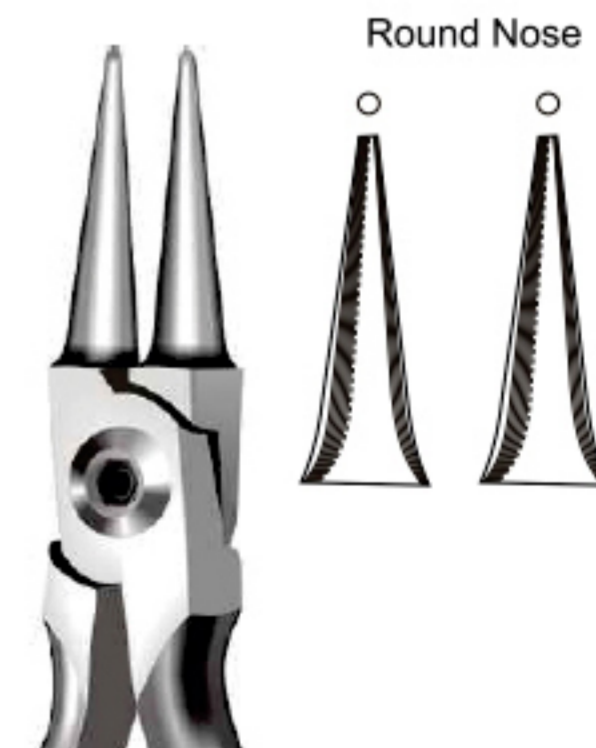

12-4412
12 cm/ 4¾"

Wire Bending Pliers

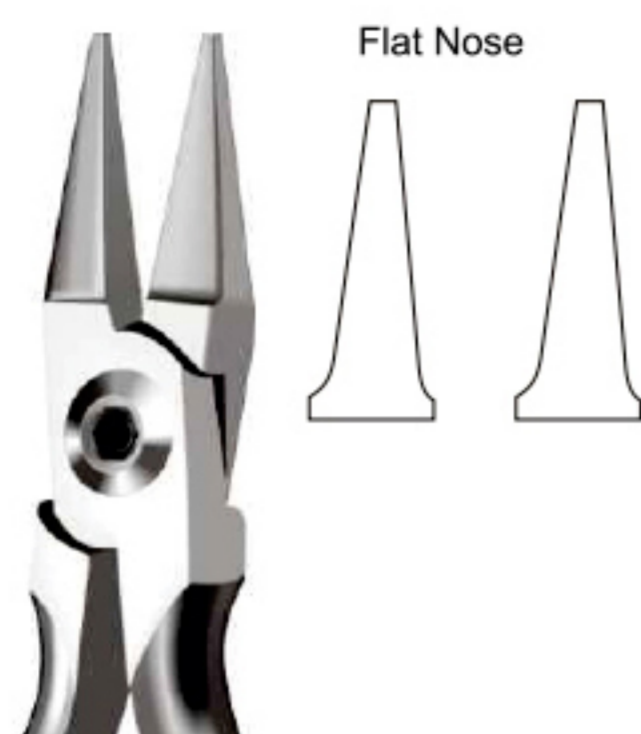

Jarabak
12-4413
 12.5 cm/ 5"
 Excellent for precise bending of light wires. Precision grooves assure accurate bending and closing loops. Wires up to .020".



Reynolds
12-4512
 12 cm/ 4¾"

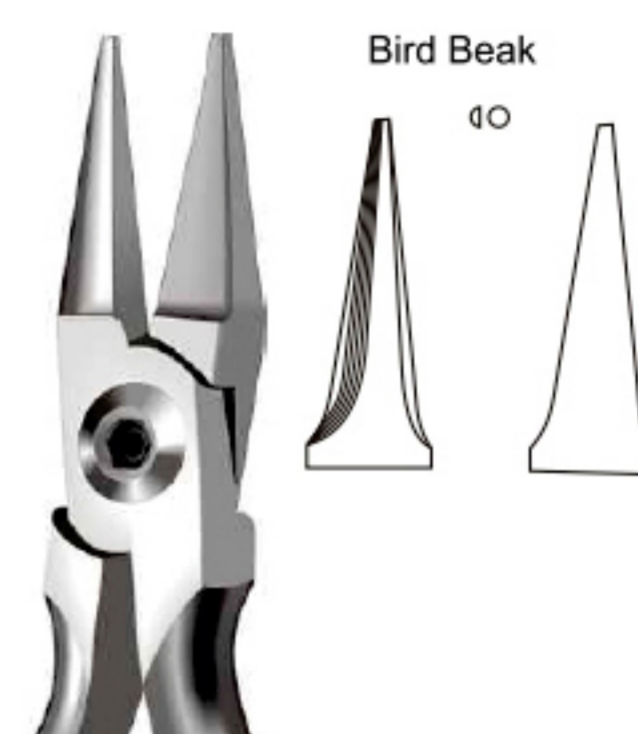

Light Wire Plier
12-4513
 12.5 cm/ 5"
 The beaks are more tapered and longer than Angle Plier. Excellent for bending small diameter loops. Used for wires up to .016" (0.41 mm)

Wire Arch Bending & Forming Pliers



Tweed
12-4611 T/C
 11.5 cm/ 4½"
 Rectangular Arch Pliers, Tweed Style Forming plier for square or rectangular wires. The blades are designed to be parallel at .020" (0.51 mm) opening. The working edges are carefully diamond-honed to prevent wire scoring.



Tweed (Angle)
12-4612 T/C
 12 cm/ 4¾"



Tweed (Angle)
12-4711 T/C
 11 cm/ 4½"

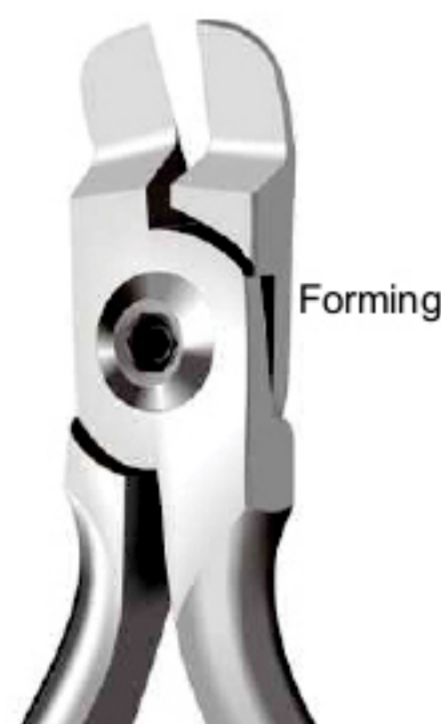

12-4811 T/C
 11 cm/ 4½"

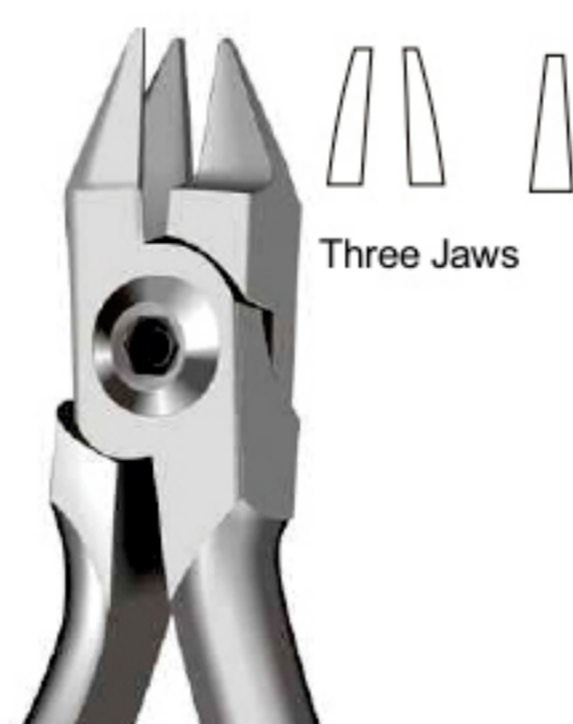

Aderer
12-4812
 11.5 cm/ 4½"
 Three Jaw Thin Plier, For wires up to .028" (0.71 mm).

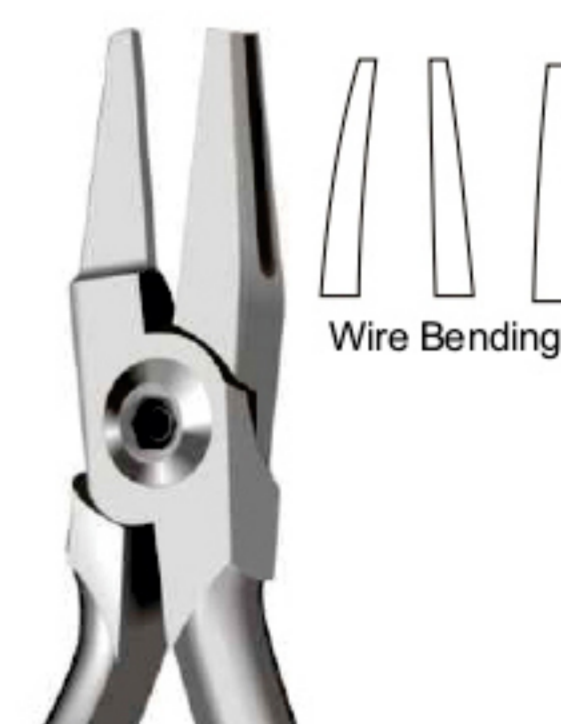

Aderer
12-4912
 12 cm/ 4¾"
 Three Jaw Plier, Aderer The precision aligned tips ensure for consistent bends. Gradually tapered for delicate bending. For wires up to 0.036" (0.91 mm)

Wire Arch Bending & Forming Pliers



How
12-4913
 13 cm/ 5¼"
 Utility Plier , How Long well tapered shape, With 3/32" (2.4mm) gripping pads which are serrated and shaped , so that their centre line coincides with the axis of rotation of the plier and holds the wire securely. Beaks are rounded to be completely lip safe.



How
12-5013
 12.5 cm/ 4¾"
 Utility Plier , How Style With 1/8" (3.2 mm) gripping pads, which are serrated to hold wire securely. Beaks are completely lip safe.



Weingart
12-5113 T/C
 12.5 cm/ 4¾"
 Utility Plier, Weingart Classic design, generally utility plier. Pointed serrated tips. Holds wire firmly at convenient angle. The beaks are rounded to make the plier completely mouth safe. Useful for removal of ceramics

Loop Forming /Bending Pliers

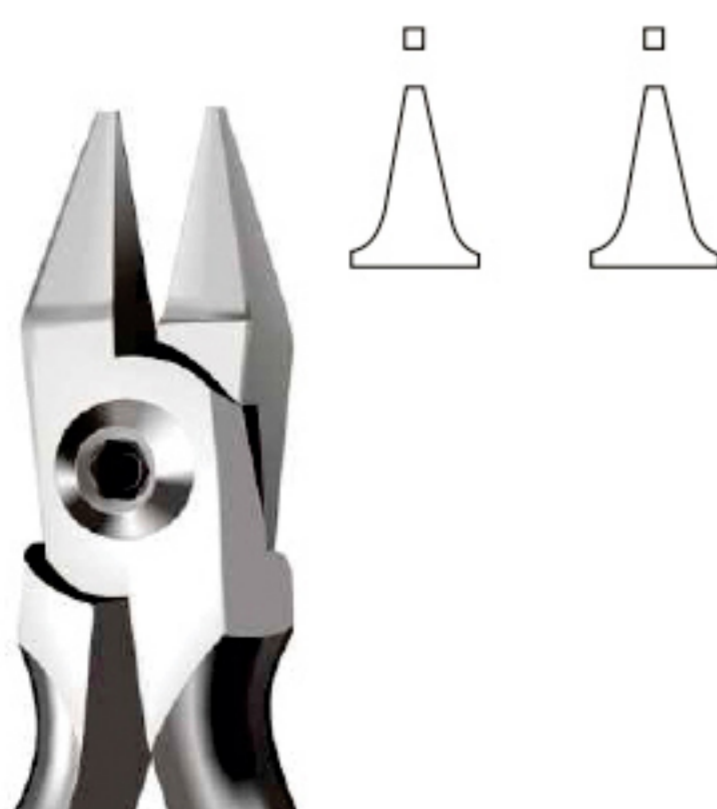

Adams
12-5212
 12 cm/ 4¾"

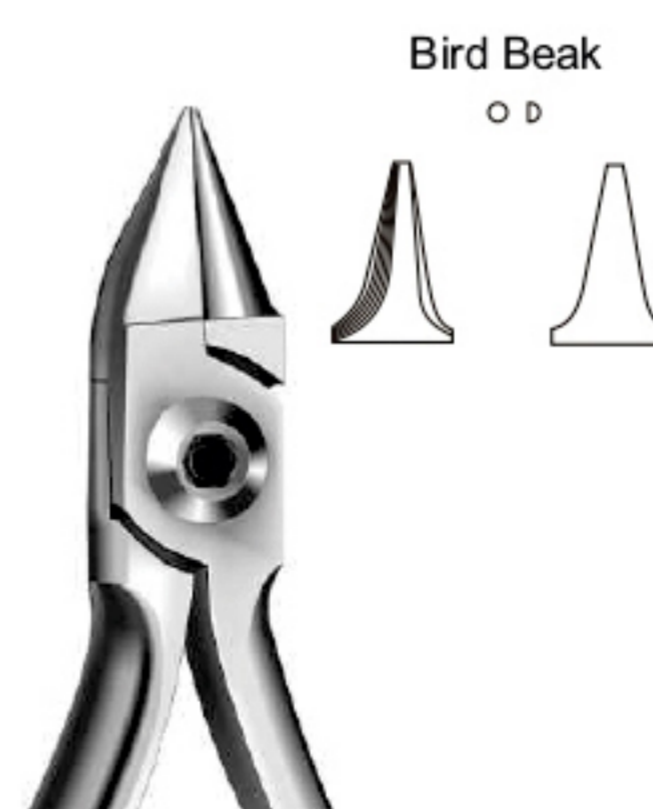

Angle
12-5312
 11.5 cm/ 4½"
 Bird Beaks Pliers, Angle It is used for working round wires up to .030" (0.76 mm) in diameter. The beaks are .025" (0.64 mm) at the tip. The beaks are parallel at 0.20" (0.51 mm) opening.

Loop Forming /Bending Pliers



Mckellops Plier
12-5313
 12.5 cm/ 5¼"
 For wires up to .059" (1.5 mm).



Tweed Loop Forming



Tweed
12-5413
 12.5 cm/ 5¼"
 Loop Forming, Tweed Style Pliers Designed for making loops in round or rectangular wires up to 0.022x.0.28" (0.56 x 0.71 mm). The cylindrical beak has three sections: 0.045" (1.14mm), .060" (1.52mm), .075" (1.90mm). Each section is 0.090" in length. The concave beak has slight parallel serrations which orient and keep the wire at a right angle to the beaks while the loop is being formed.



Omega Loop Forming



Tweed
12-5513
 12.5 cm/ 5¼"
 Omega Loop Forming Pliers, Tweed Style It just differs from the Model 12-5413 in the concave beak which is rounded for making more uniform omega loops.



Single Diameter Loop Forming



Tweed
12-5613
 12.5 cm/ 5¼"



12-6612
 Loop Closing Plier, Nance Style
 Box joint with 4 sectioned tip for forming various size loops in rectangular and round wires.
 For wires up to .028" (0.71 mm).

Wire Cutting Pliers



12-5713 T/C
12.5 cm/ 5"
Hard Wire Cutter, Flat Back
Cutting capacity up to .020 round,
Arch wire up to .022 x .028 and all
sizes of ligature wire and pins.



12-5813 T/C
12.5 cm/ 5"



12-5913 T/C
13 cm/ 5½"



12-6012 T/C
12 cm/ 5"



12-6112 T/C
11.5 cm/ 4½"



12-6212 T/C
12 cm/ 5"
Mini cut & hold distal end cutter
cuts within 0.5mm from end of
buccal tube. Use on wire up to
0.22" x 0.28" rectangular and
0.20" round.



12-6312 T/C
11.5 cm/ 4½"
Distal End Cutter with safety hold
It shear cuts hard wire and braided
wire and then, safely holds the loose
distal ends of the wire. thus preventing
from falling down into the oral tissues.
The cutting edges are diamond honed.
Maximum cutting capacity: rectangular
and twist wires up to .022 x .028"
(0.56 x 0.71); round wire up to .020"
(0.51 mm) in diameter.

CH 13-18

CH 13 Knives, Scalpels

CH 14 Scissors

CH 15 Forceps, Hemostatic Forceps

CH 16 Needle holders

CH 17 Retractors

CH 18 Bone Cutting Forceps,
Bone Rongeurs





Ash
PE.25.01-
PE.25.03



1/1
PE.25.01
Fig. 1



PE.25.02
Fig.2



PE.25.03
Fig.3



1/1
PE.03.10
Fig.10



PE.03.11
Fig.11



Standard
PE.04.03
No.3



PE.09.04
No.4



PE.06.17
No.7K



PE.05.07
No.7



PE.10.40
No.3
straight

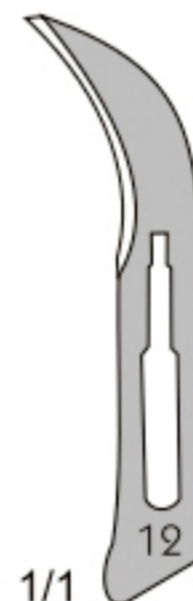

1/1
PE.03.12
Fig.12

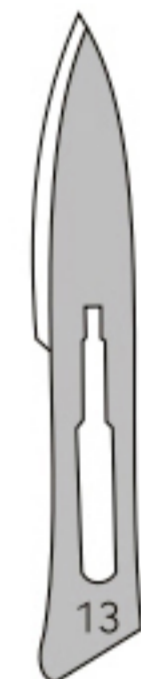

PE.03.13
Fig.13



1/1
PE.03.14
Fig.14



PE.03.15
Fig.15

Operating Scissors



Standard
PC.14.14
PC.14.64 "TC"
PC.18.14.
PC.18.64 "TC"
 14,5 cm/ 5 3/4"
 Blunt/ Blunt



Standard
PC.15.14
PC.15.64 "TC"
PC.19.14
PC.19.64 "TC"
 14,5 cm/ 5 3/4"
 Sharp/ Sharp



Standard
PC.16.14
PC.16.64 "TC"
PC.17.14
PC.17.64 "TC"
 14,5 cm/ 5 3/4"
 Sharp/ Blunt



Metzenbaum
PC.36.14
 14,5 cm/ 5 3/4"



Metzenbaum
PC.37.14
 14,5 cm/ 5 3/4"



Metzenbaum-Delicate
PC.42.14 14,5 cm/ 5 3/4"
PC.44.18 18 cm/ 7"



Metzenbaum-Delicate
PC.43.14 14,5 cm/ 5 3/4"
PC.45.18 18 cm/ 7"



PC.01.11-PC.08.91
 11,5 cm/ 4 1/2"

Gum Scissors
 Zahnfleischscheren
 Tijeras para encias
 Ciseaux à gencives
 Forbrci per gengiva



PC.01.11

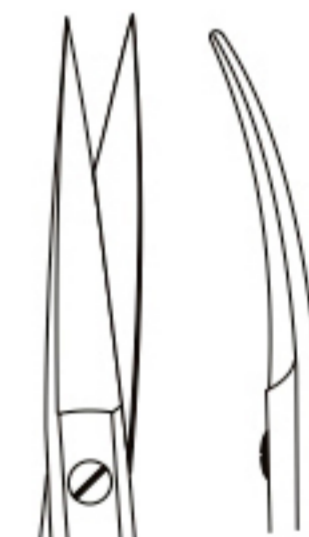

PC.02.11



PC.08.90



PC.08.91

Gum Scissors
 Zahnfleischscheren
 Tijeras para encias
 Ciseaux á gencives
 Forbrci per gengiva

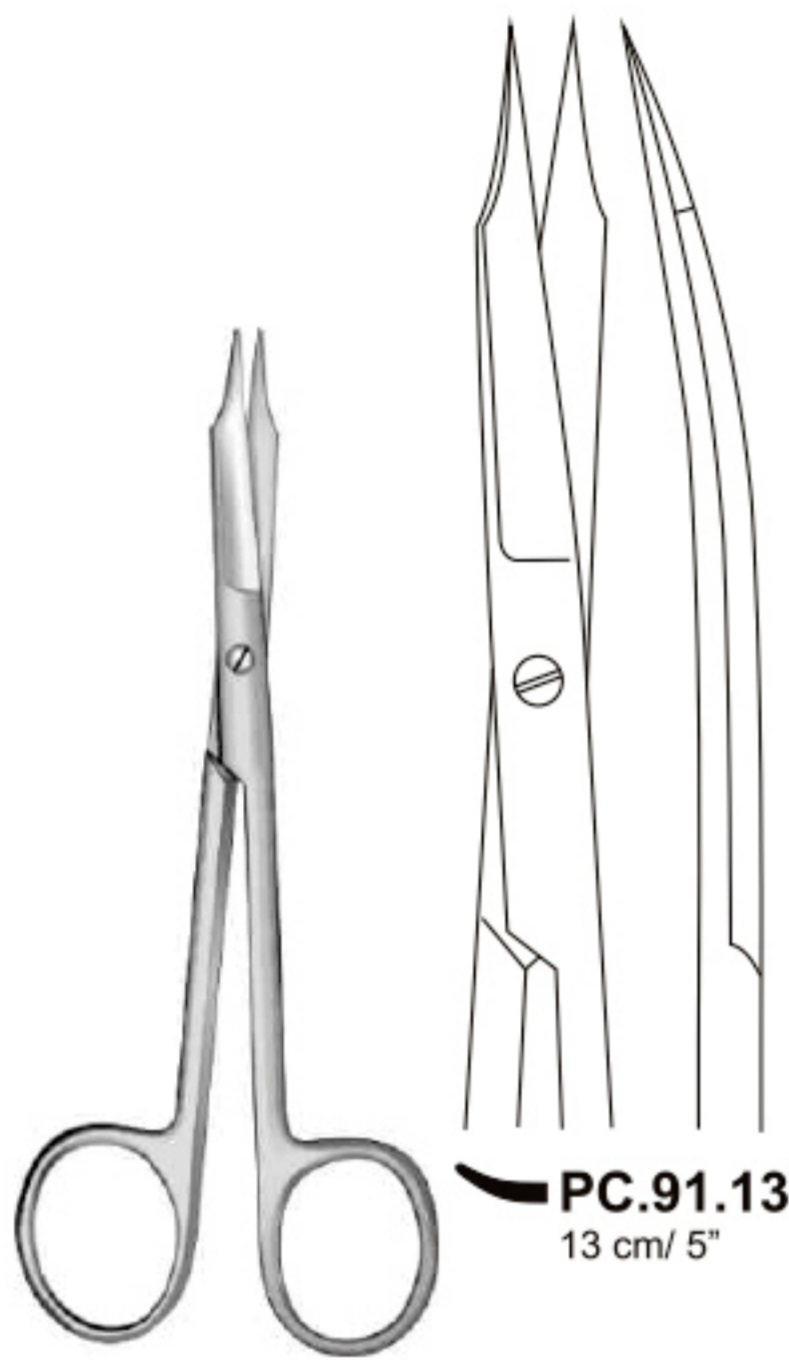

PC.90.13
13 cm/ 5"

PC.91.13
13 cm/ 5"

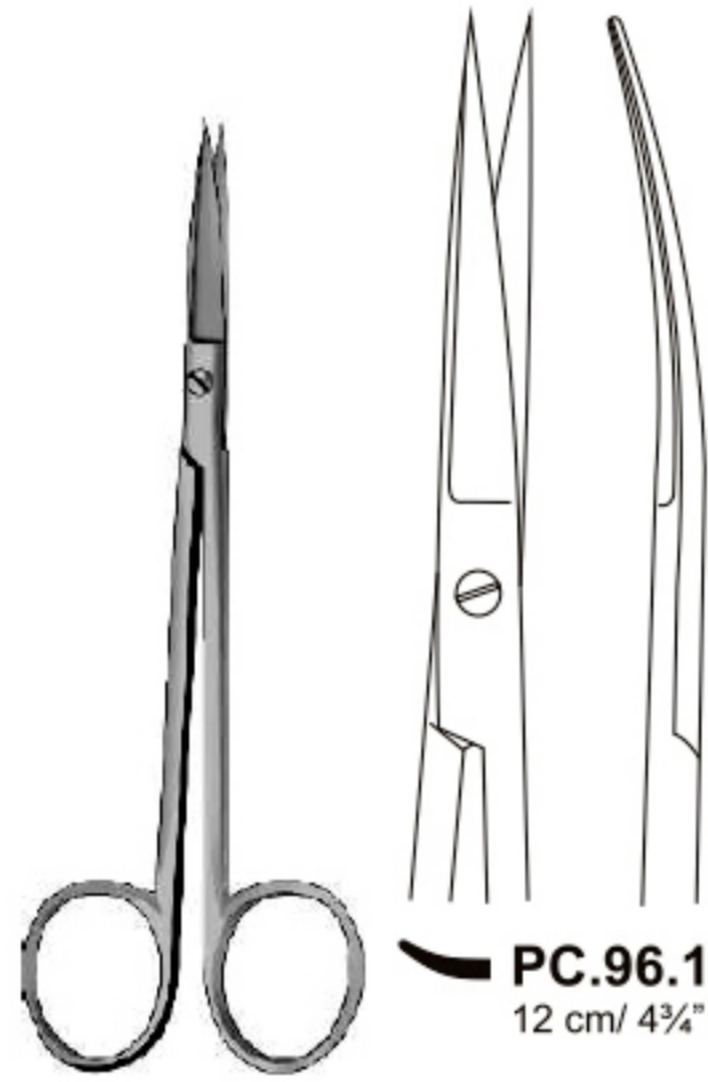

Wagner
PC.95.12
12 cm/ 4¾"

PC.96.12
12 cm/ 4¾"

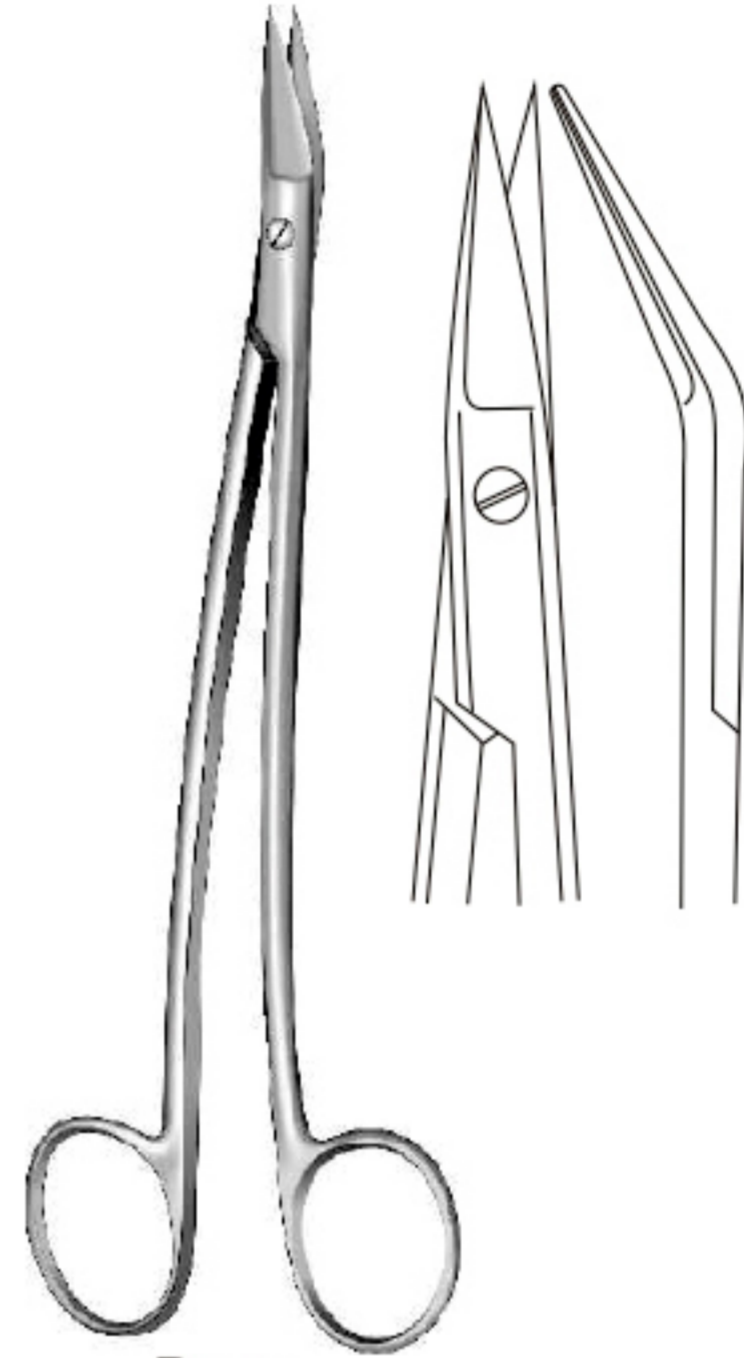

Dean
PAK.25.17
17 cm/ 6¾"

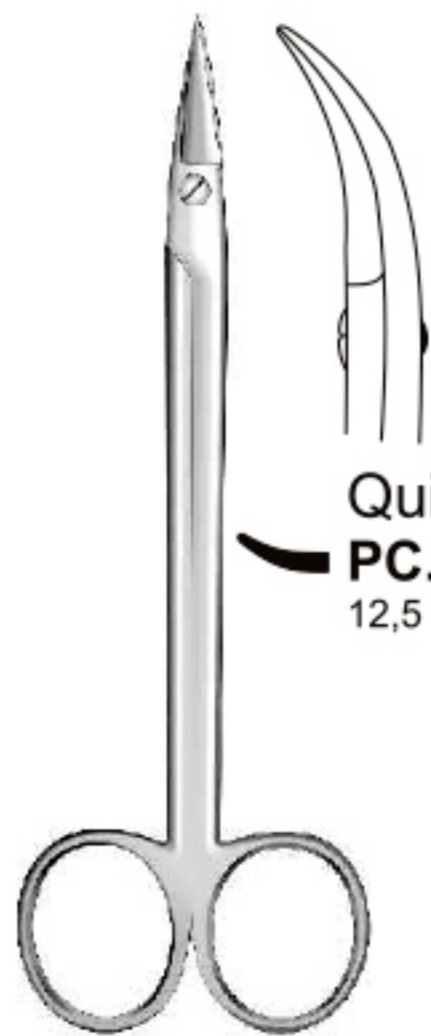

Quinby
PC.110.13
12,5 cm/ 5"

Quinby
PC.111.13
12,5 cm/ 5"



La Grange
PC.120.11
10,5 cm/ 4"

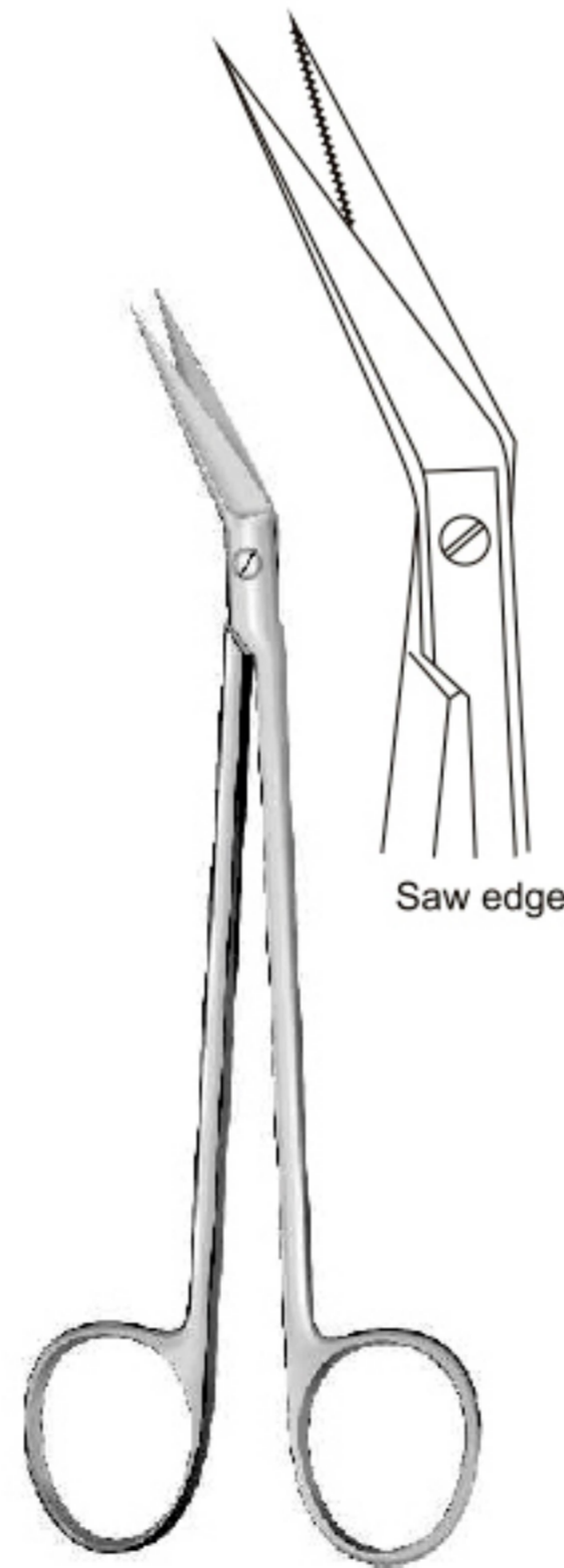

Locklin
PC.115.16
16 cm/ 6¼"

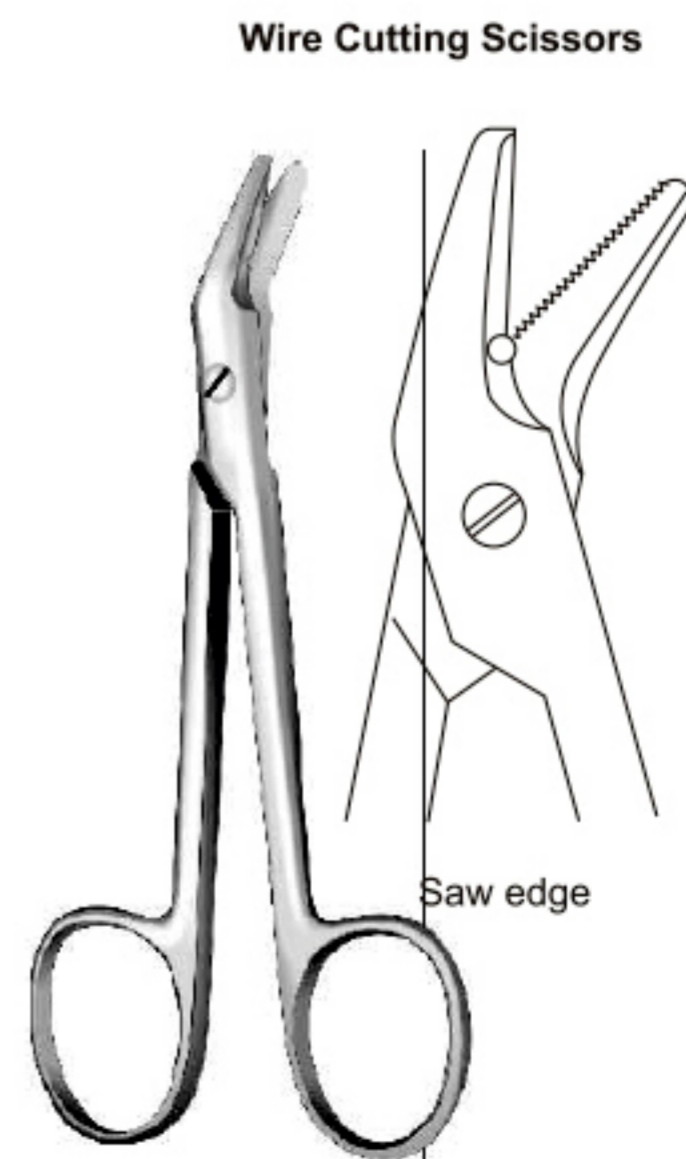

Universal
PS.23.12
12 cm/ 4¾"



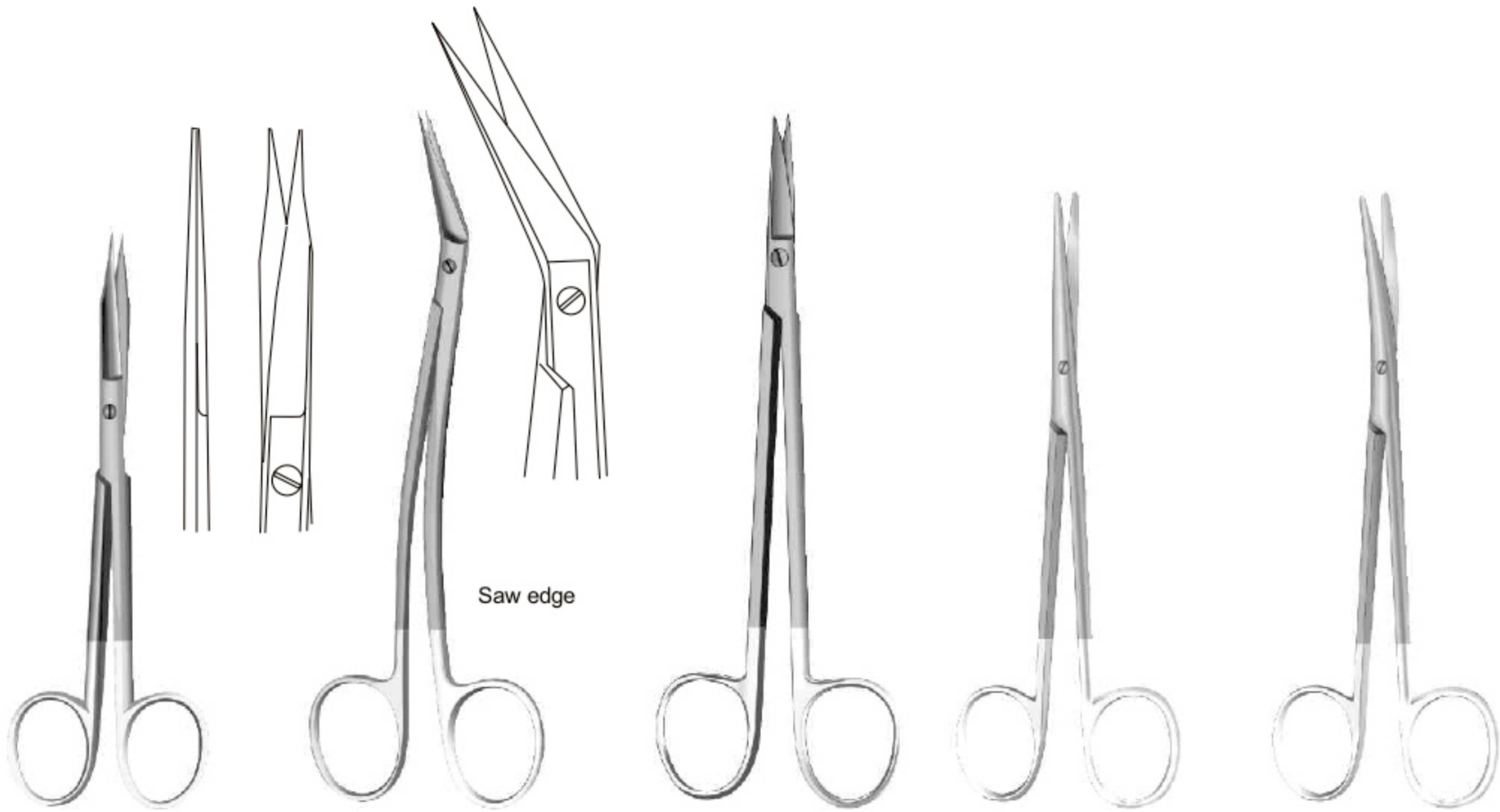

Wire Cutting Scissors







PC.91.53
13 cm/ 5"

Locklin
PC.115.66
16 cm/ 6¼"

Kelly
 **PC.46.66** 16 cm/ 6¼"
 **PC.47.66** 16 cm/ 6¼"

Metzenbaum
 **PC.36.64** 14 cm/ 5½"
 **PC.37.64** 14 cm/ 5½"
 **PC.38.70** 20 cm/ 8"
 **PC.39.70** 20 cm/ 8"

Metzenbaum-Fine
 **PC.42.64** 14 cm/ 5½"
 **PC.43.64** 14 cm/ 5½"
 **PC.44.70** 20 cm/ 8"
 **PC.45.70** 20 cm/ 8"

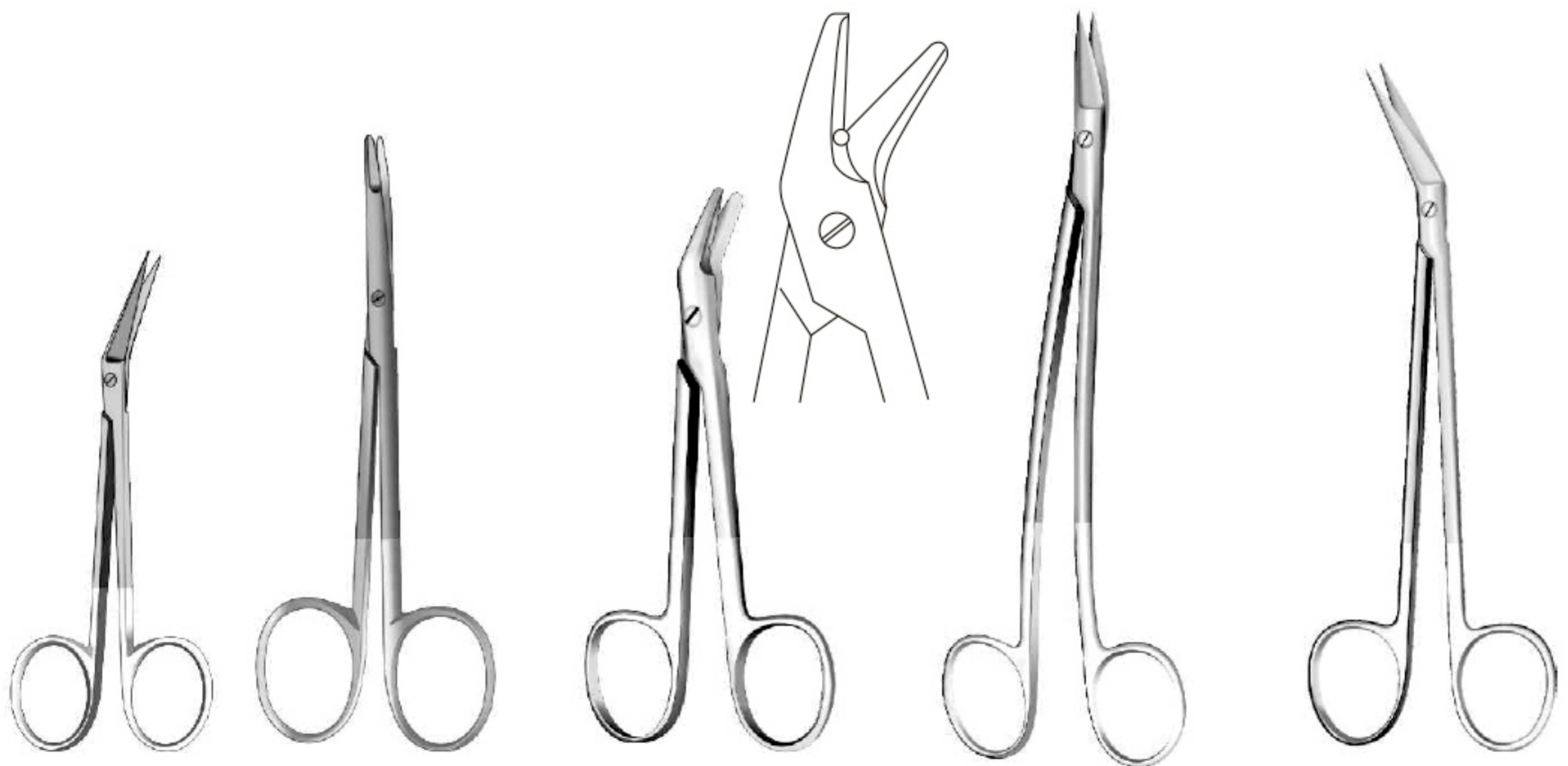

PC.08.92
11,5 cm/ 4½"

Ragnell (Killner)
PC.59.63
13 cm/ 5½"

Universal
PS.24.12
12 cm/ 4¾"

Dean
PAK.25.57
17 cm/ 6¾"

Locklin
PC.115.66
16 cm/ 6¼"
Saw Edge



	Standard	Standard	Adson		Adson	Adson Brown
12 cm/ 4¾"	PF.01.11	PF.05.11	PF.15.12		PF.16.12 12 cm/ 4¾"	PF.21.12
14.5cm/ 5¾"	PF.01.14	PF.05.14			PF.16.15 15 cm/ 6"	PF.21.15
15cm/ 6"	PF.01.15	PF.05.15	PF.15.15			
16 cm/ 6¼"	PF.01.16	PF.05.16				
18 cm/ 7"	PF.01.18	PF.05.18				
20 cm/ 8"	PF.01.20	PF.05.20				
25 cm/ 10"	PF.01.25	PF.05.25				

Semken
PF.30.15
15.5 cm/ 6"

Adson
PF.16.12 12 cm/ 4¾"
PF.16.15 15 cm/ 6"

Adson Brown
PF.21.12
PF.21.15

With Tungsten Carbide "TC"



	Standard "TC"	Narrow "TC"	Adson "TC"	Cushing "TC"
12 cm/ 4¾"	PF.01.62	PF.03.62	PF.15.62	PF.52.67 17cm / 6¾"
14.5cm/ 5¾"	PF.01.64	PF.03.64		
15cm/ 6"	PF.01.65		PF.15.65	
16 cm/ 6¼"	PF.01.66	PF.03.66		
18 cm/ 7"	PF.01.68	PF.03.68		



London College
15 cm/ 6"
15-0915 - 15-1515
WO: Without Lock
15-0916 - 15-1516
WL: With Lock



Meriam
16 cm/ 6¼"
15-1716 - 15-2216
WO: Without Lock
15-1717 - 15-2217
WL: With Lock



FIG . 1
WO **15-0915**
WL **15-0916**



FIG . 2
15-1015
15-1016



FIG . 3
15-1115
15-1116



FIG . 4
15-1215
15-1216



FIG . 5
WO **15-1315**
WL **15-1316**



FIG . 6
15-1415
15-1416



FIG . 7
15-1515
15-1516



FIG . 1
WO **15-1716**
WL **15-1717**



FIG . 2
15-1816
15-1817



FIG . 3
15-1916
15-1917



FIG . 4
15-2016
15-2017



FIG . 5
WO **15-2116**
WL **15-2117**



FIG . 6
15-2216
15-2217



Flagg
16 cm/ 6¼"
15-1616 Smooth
15-1626 Serrated



Perry
13 cm/ 5"
15-2410 Serrated
15-2413 Smooth



Albrecht
15-2516 Sharp
15-2517 Blunt
 16 cm/ 6¼"



USA-Mod.
15-2615
 15 cm/ 6"



15-2715
 15 cm/ 6"



Caulk
15-2815
 16,5cm/ 6½"



15-2915
 15 cm/ 6"

Articulating Forceps



Miller
15-3415
 15cm/ 6 "



USA-Mod.
15-3016
 16 cm/ 6¼"



USA-Mod.
15-3116
 16 cm/ 6¼"



USA-Mod.
15-3216
 16 cm/ 6¼"



Crane-Keplan
15-3301
 14 cm/ 5½"



Crane-Keplan
15-3302
 14 cm/ 5½"

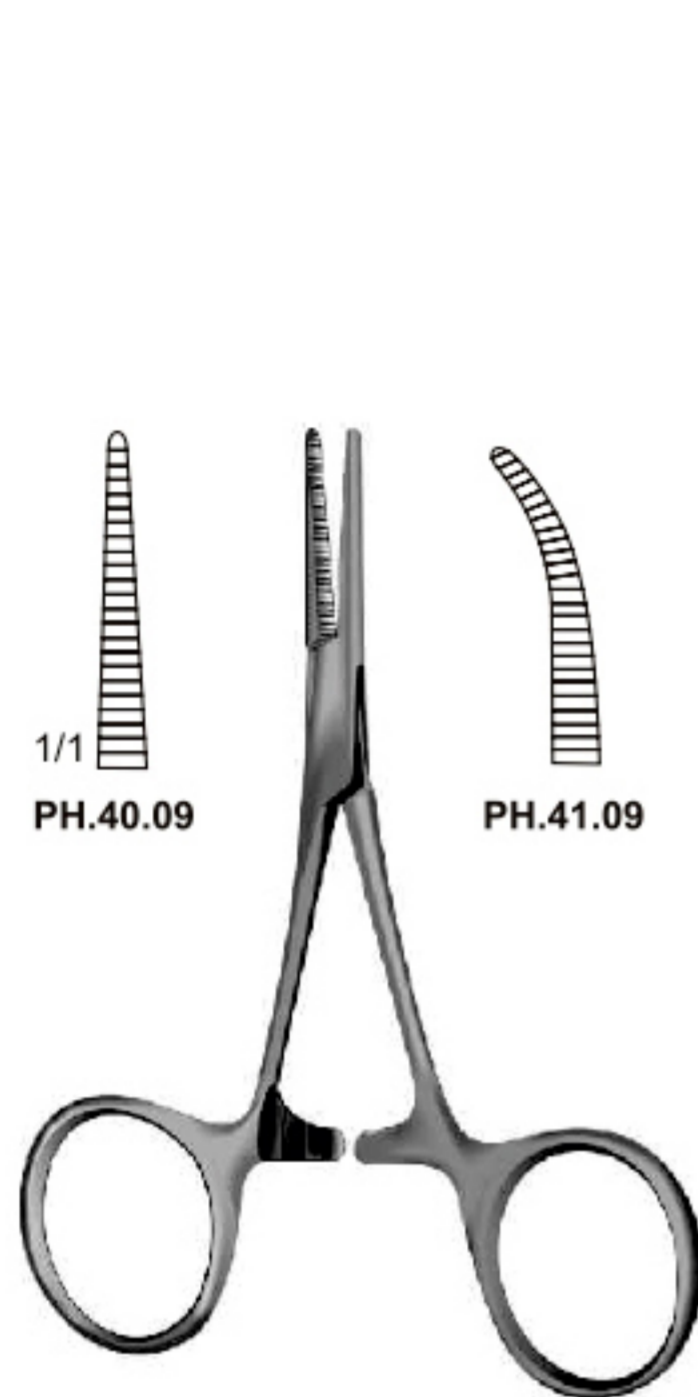

Hartmann
PH.40.09 - PH.41.09
 10 cm/4" 10 cm/4"
 Straight Curved

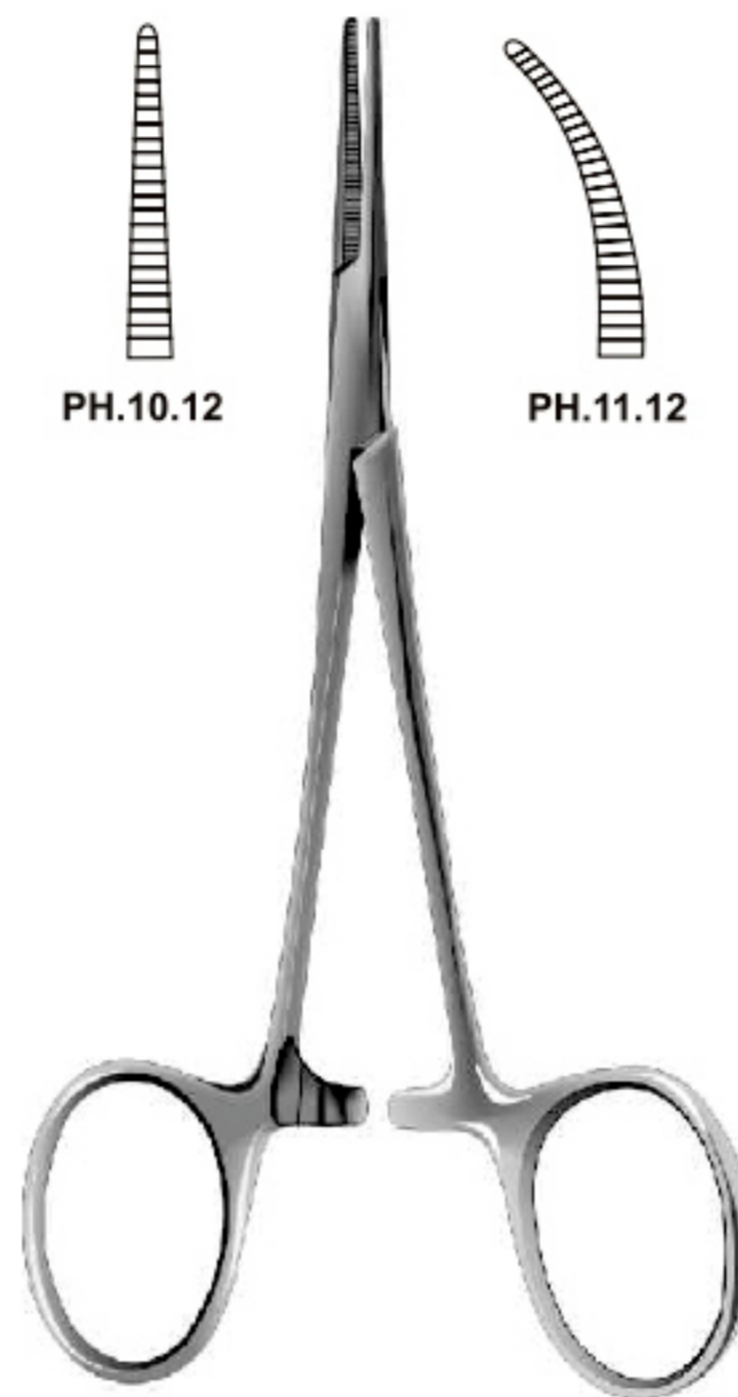

Halstead
PH.10.12 - PH.11.12
 12 cm/4 3/4" 12 cm/4 3/4"
 Straight Curved

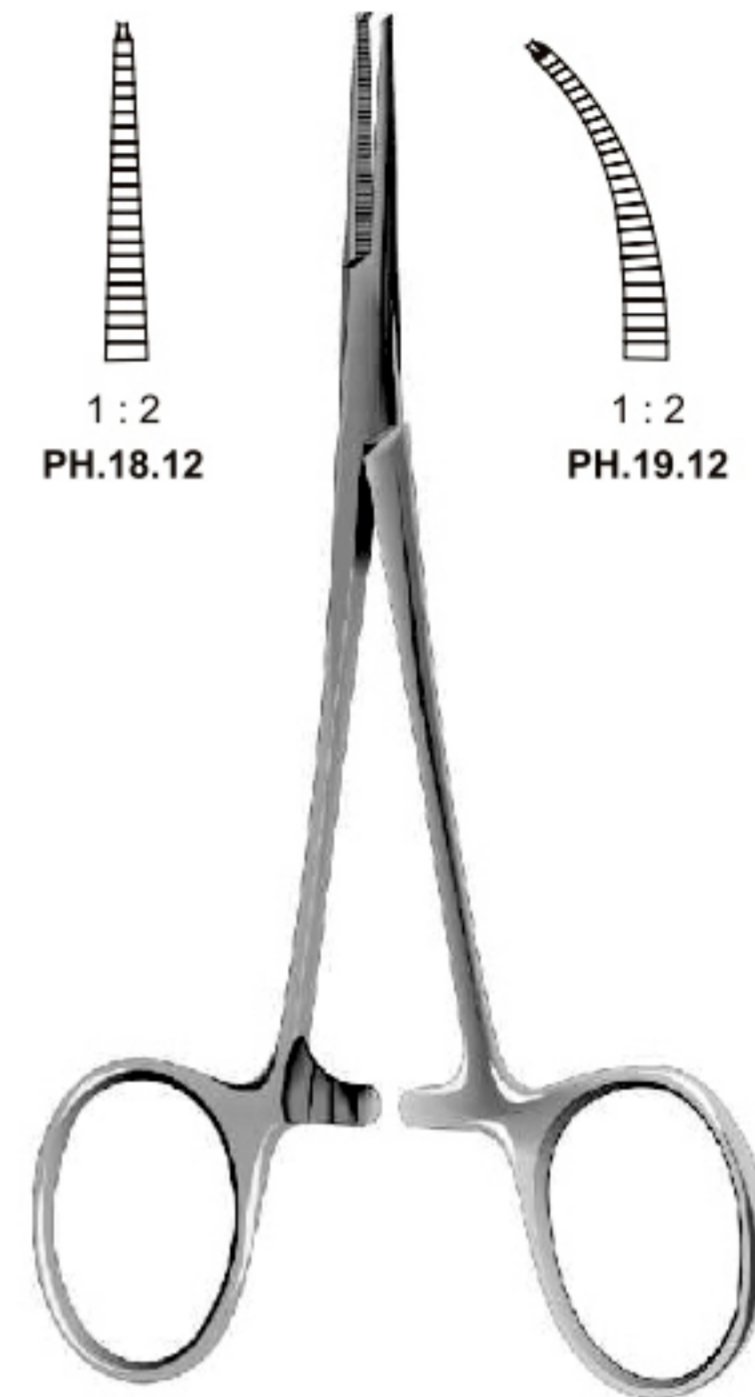

Halsted-Mosquito
PH.18.12 - PH.19.12
 12.5 cm/5" 12 cm/5"
 Straight Curved



Jones
PI.19.06 6 cm/ 2 1/2"
PI.20.09 9 cm/ 3 1/2"

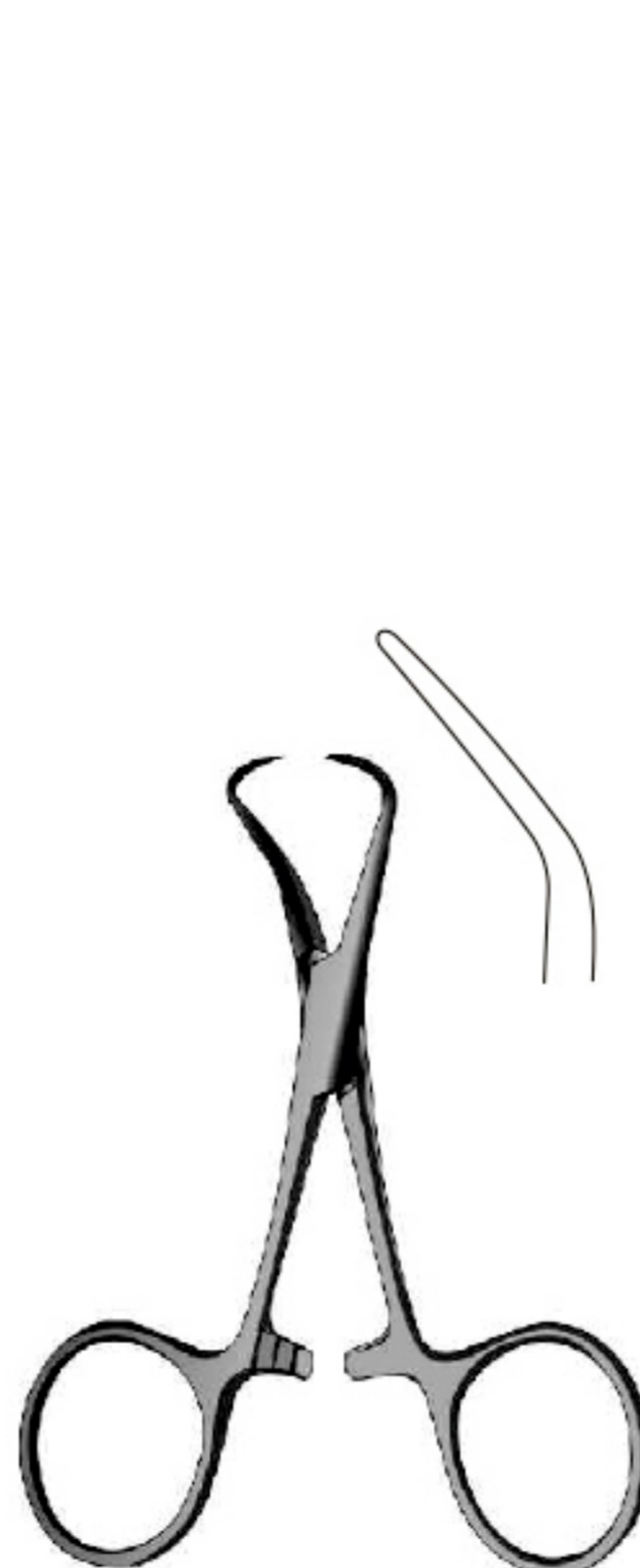

Backhaus
PI.25.08 8 cm/ 3 1/4"
PI.25.10 11 cm/ 4 1/2"
PI.26.13 13 cm/ 5"

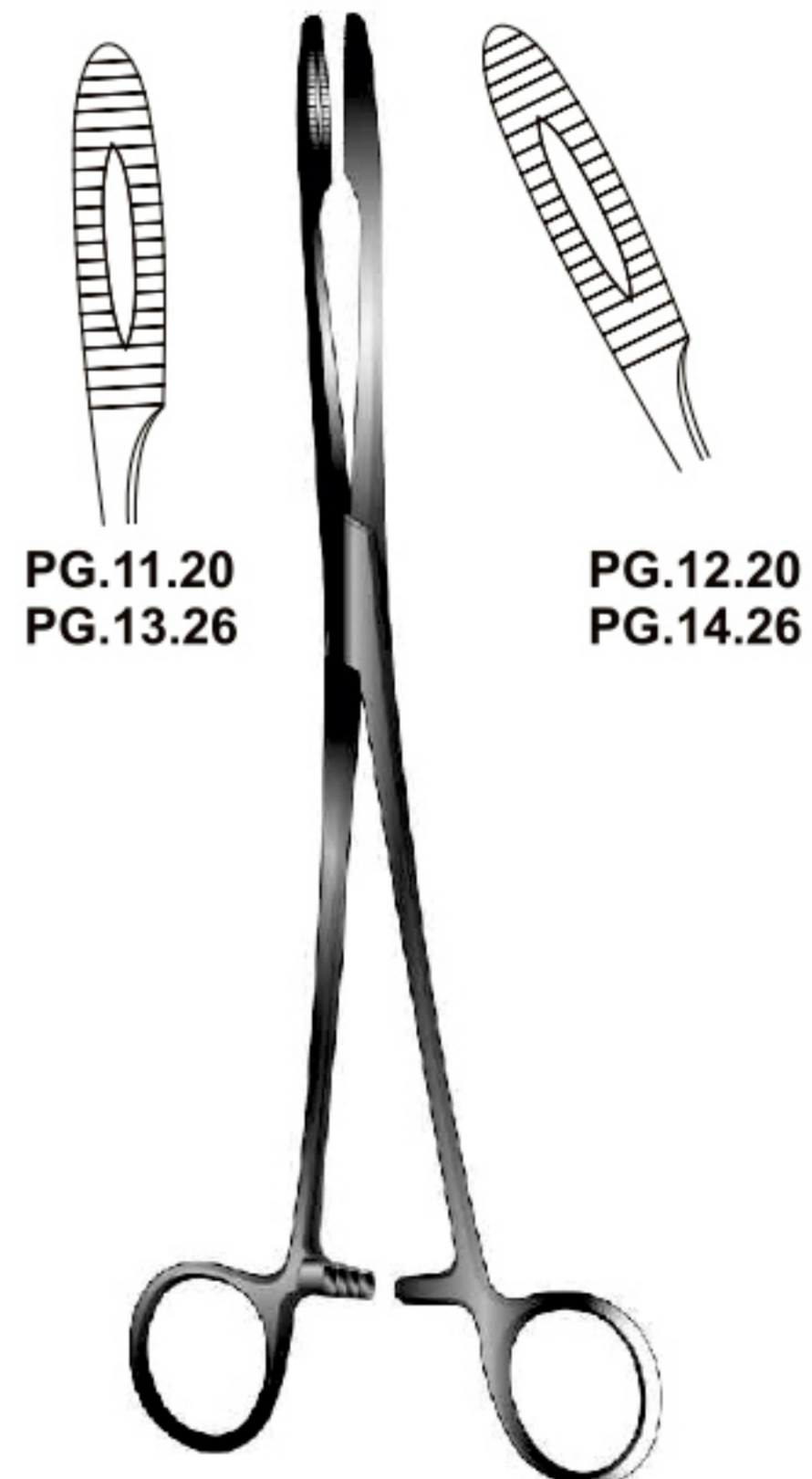

Gross-Maier
PG.11.20 - PG.13.26
PG.12.20 - PG.14.26
 20cm/ 8" 26cm/ 10 1/4"

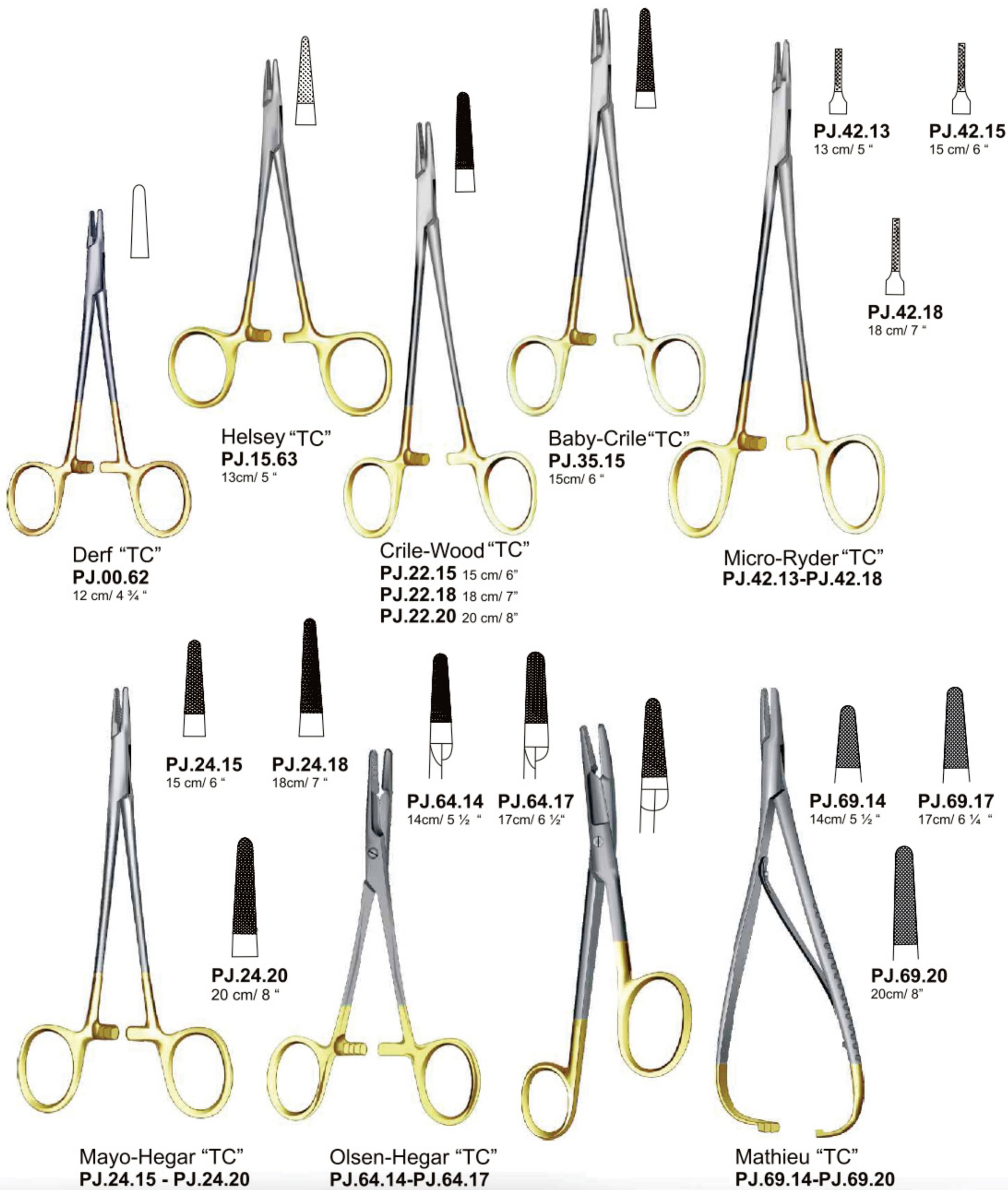

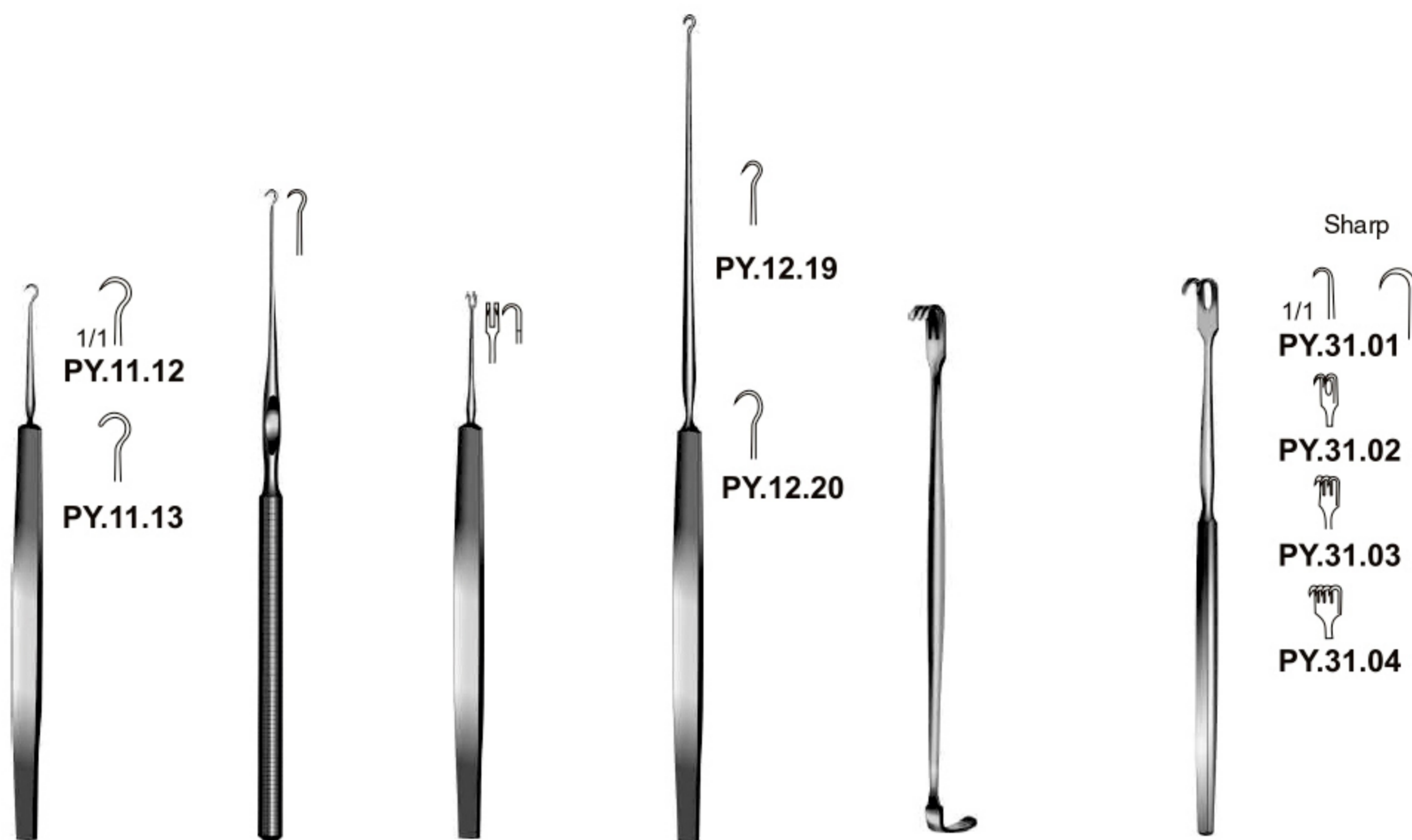

Frazier
PY.11.12-
PY.11.13
 13 cm/ 5 ¼"

Kilner
PAE.11.15
 15 cm/ 6"

Guthrie
PY.25.13
 13 cm/ 5"

Gillies
PY.12.19-
PY.12.20
 19 cm/ 7"

Senn-Miller
PY.01.16
 16 cm/ 6¼"

PY.31.01 -
PY.31.04
 16 cm/ 6¼"

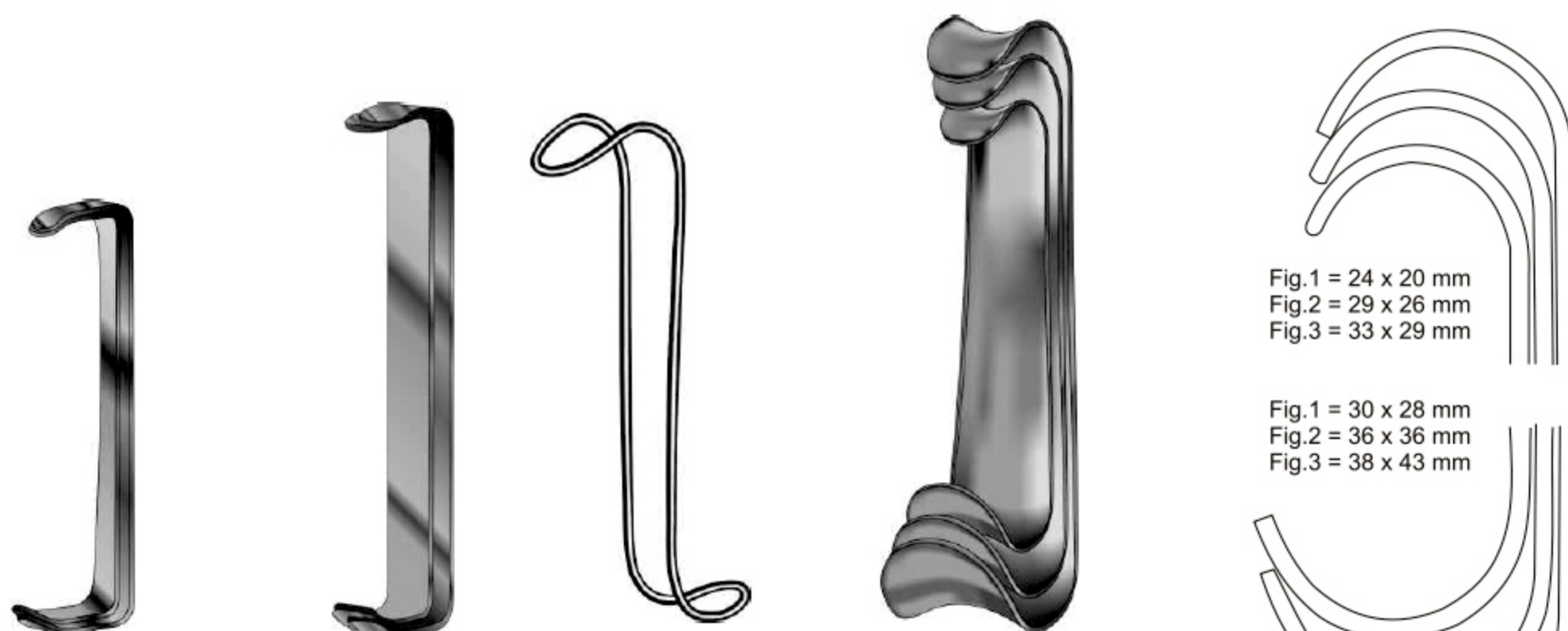

Farabeuf
PY.46.12
 12 cm/ 4 ¾"

Farabeuf
PY.47.15
 15 cm/ 5"

Collin-Hartmann
PY.45.14 14 cm/ 5 ½"
PY.45.16 16 cm/ 6 ¼"

Roux
 Roux Set of 3.
PY.49.00 Set of 3
PY.49.01 Fig.1
PY.49.02 Fig.2
PY.49.03 Fig.3

Fig.1 = 24 x 20 mm
 Fig.2 = 29 x 26 mm
 Fig.3 = 33 x 29 mm

Fig.1 = 30 x 28 mm
 Fig.2 = 36 x 36 mm
 Fig.3 = 38 x 43 mm

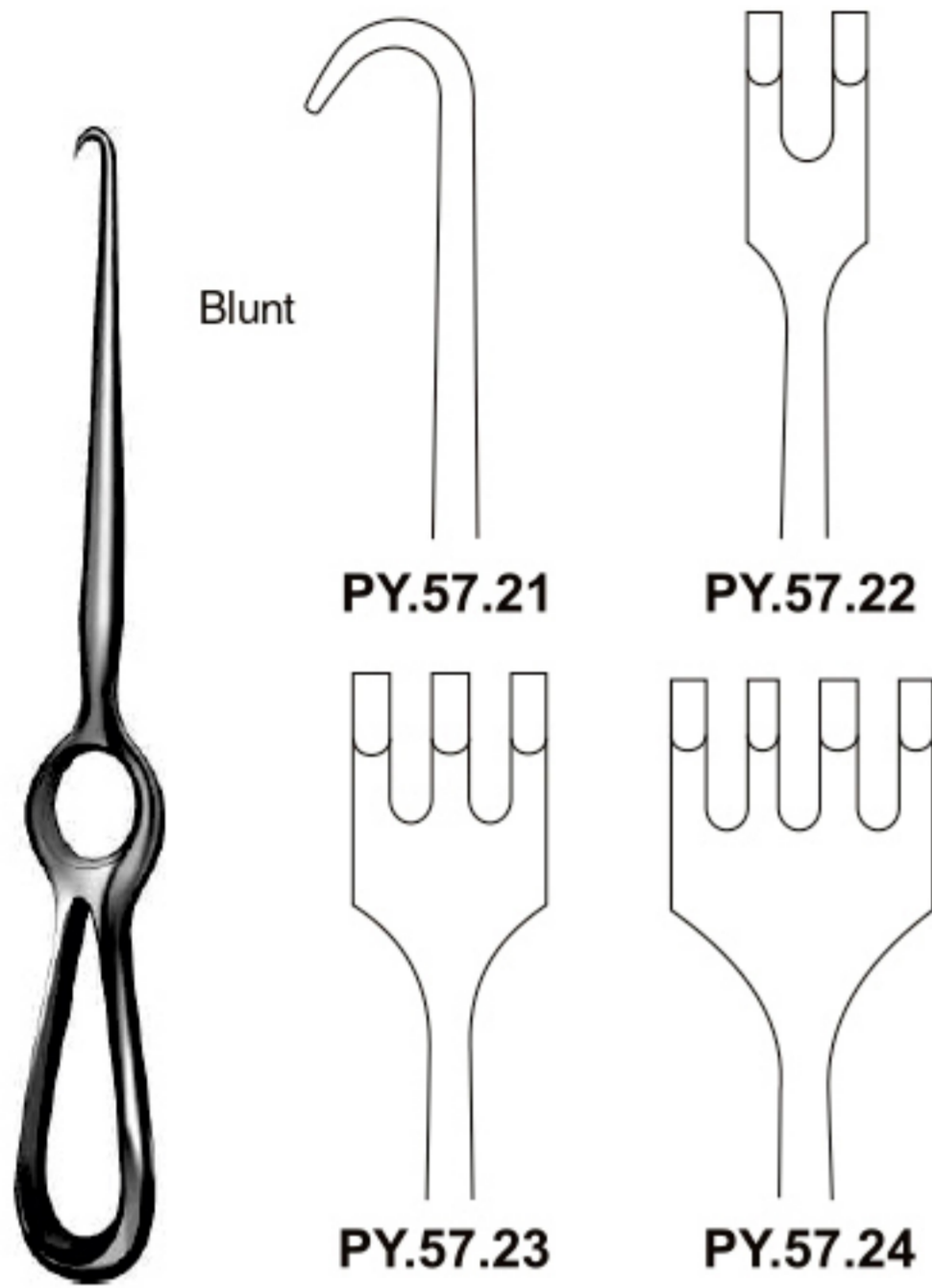

Blunt

PY.57.21

PY.57.22

PY.57.23

PY.57.24

Volkmann
PY.57.21-PY.57.24
21.5 cm/ 8 1/2"

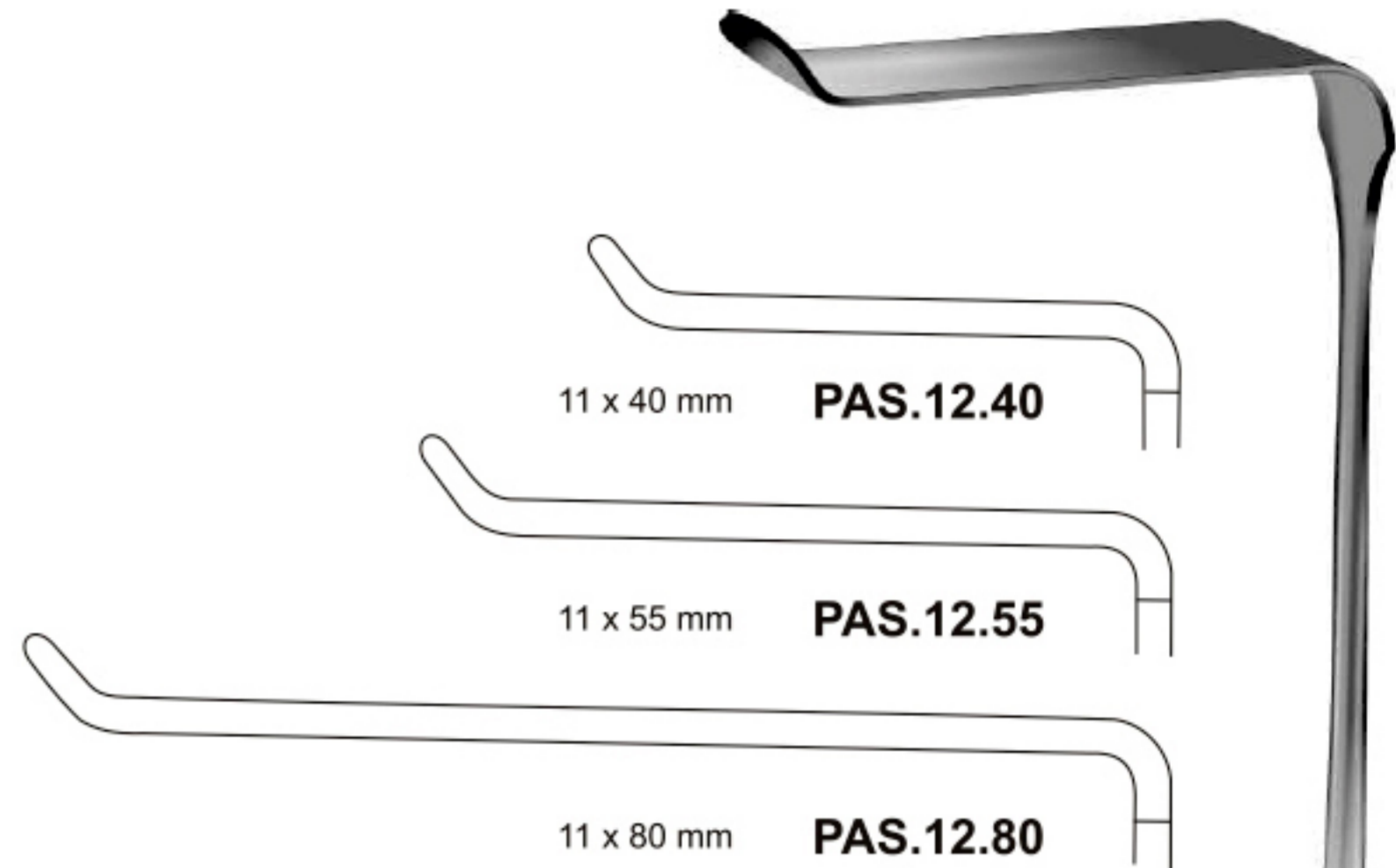

11 x 40 mm PAS.12.40

11 x 55 mm PAS.12.55

11 x 80 mm PAS.12.80

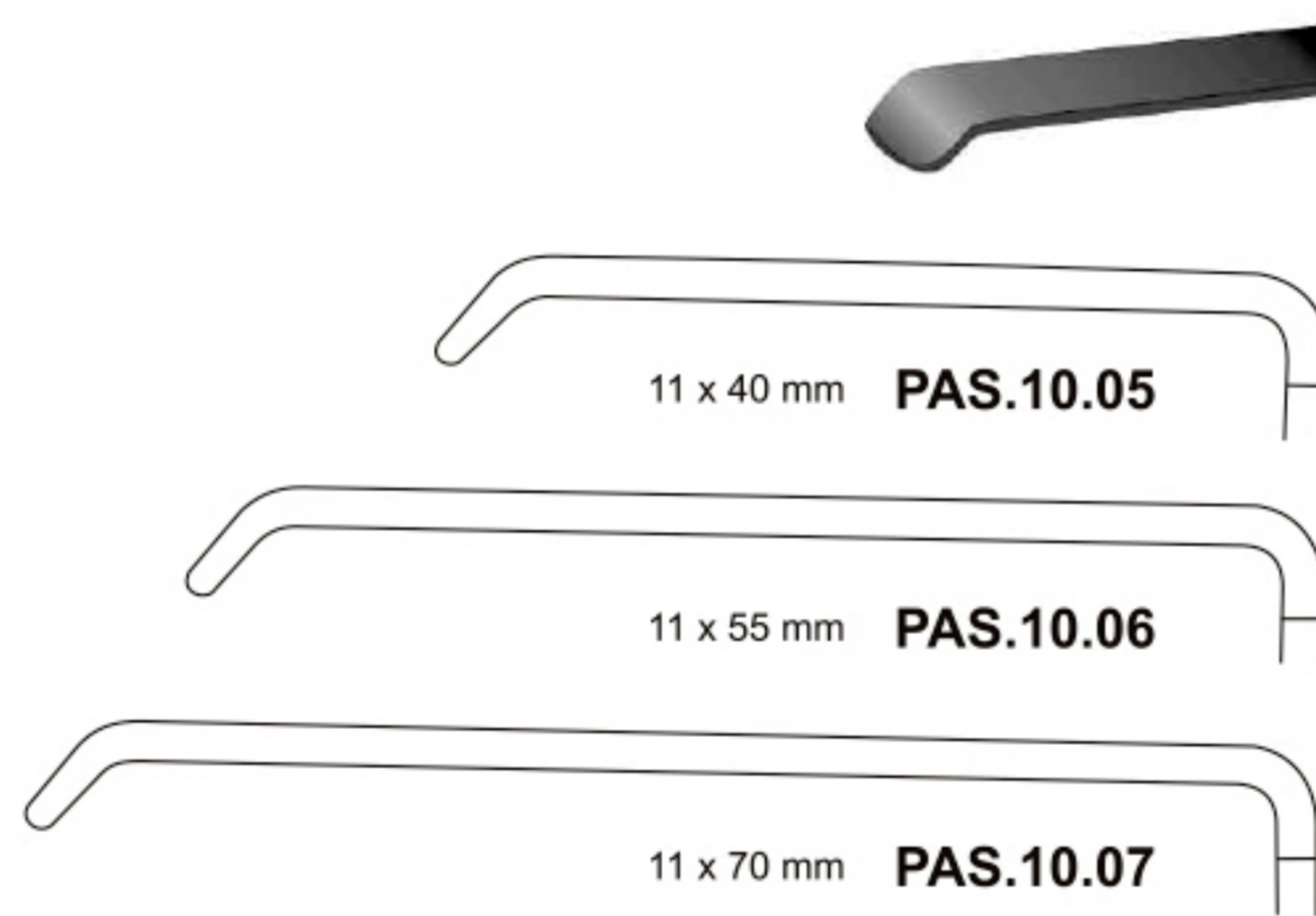

11 x 40 mm PAS.10.05

11 x 55 mm PAS.10.06

11 x 70 mm PAS.10.07



PY.71.01
30 x 11 mm



PY.71.02
30 x 14 mm



PY.71.03
30 x 16 mm

Langenbeck
PY.71.01- PY.71.03
21cm/ 8 1/4 "

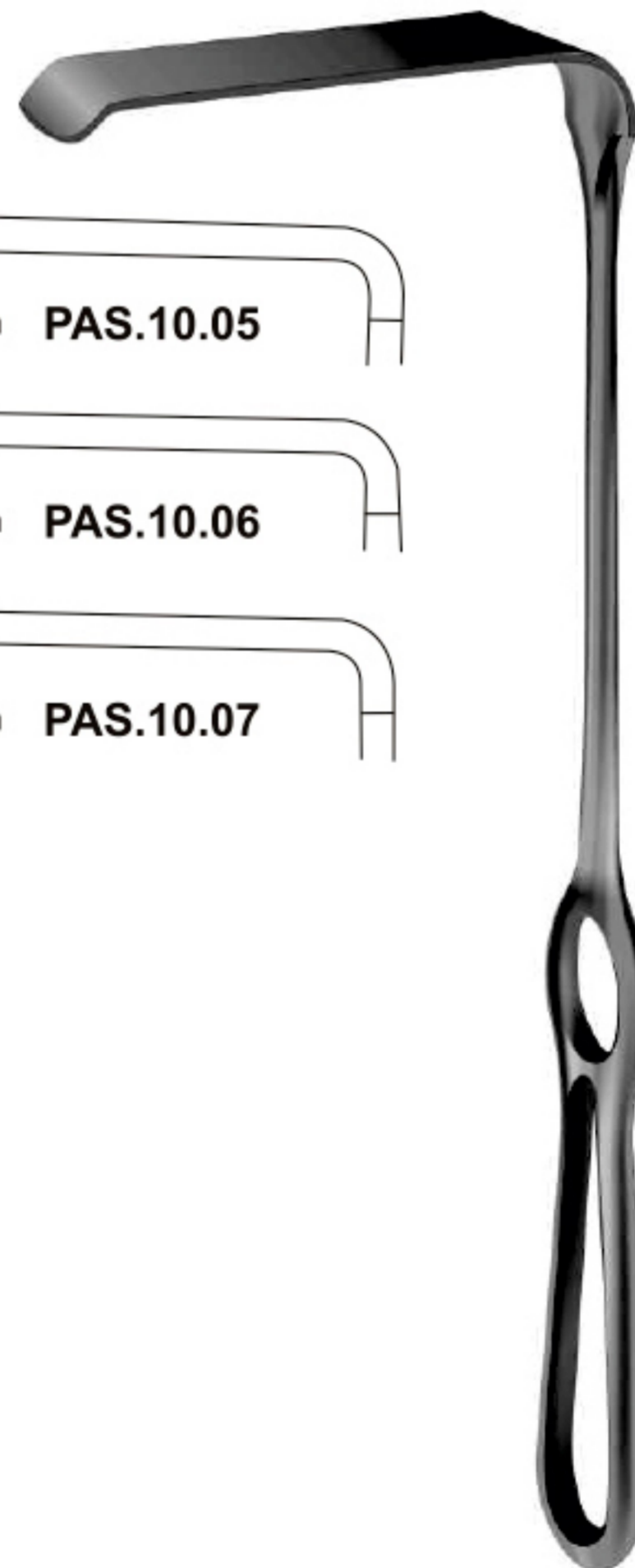

Obwegeser
PAS.12.40-
PAS.12.80
22 cm/8 3/4 "

Obwegeser
PAS.10.05 -
PAS.10.07
21,5 cm/8 1/2"

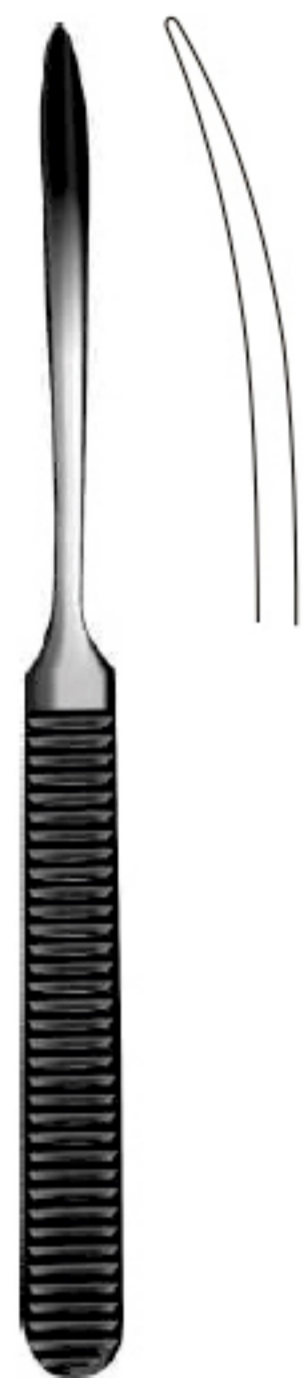

Williger
PT.11.17
17 cm/6 3/4"

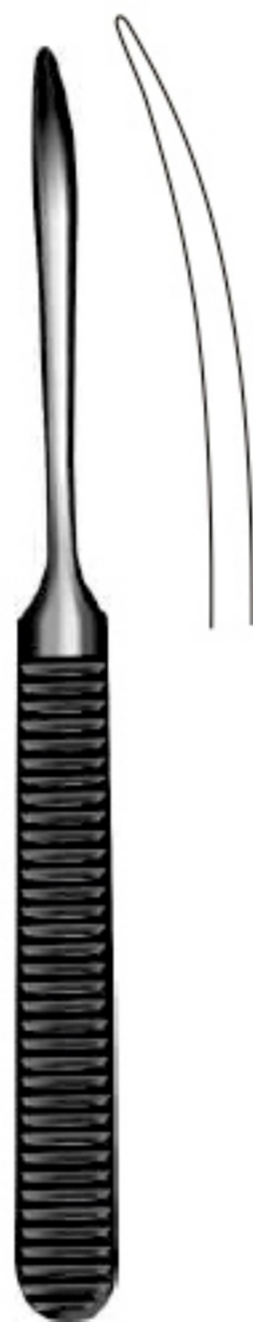

Williger
PT.12.04
16 cm/6 1/4"



Freer
PAM.28.21
21.5 cm/ 8 1/2"



PT.19.20
17,5 cm/7"



Molt
PT.19.21
19 cm/7 1/2"

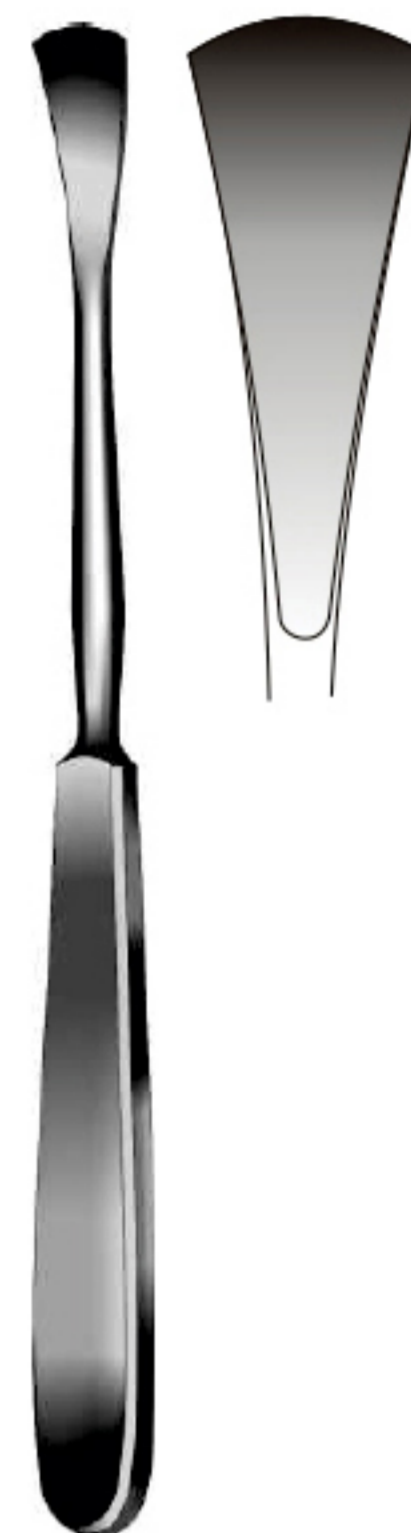

Lengenbeck
PT.37.35
19 cm/7 1/2"

Bone Nibblers.

- 1mm
PAC.37.01
- 2mm
PAC.37.02
- 3mm
PAC.37.03



Citelli
PAC.37.01-
PAC.37.03
17 cm/6 3/4"

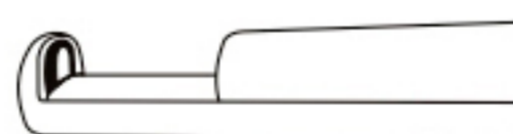

- 4 x 4 mm
PAC.36.01
- 5 x 5 mm
PAC.36.02
- 6 x 6 mm
PAC.36.03



Kerrison
PAC.36.01-
PAC.36.03



Friedman
PX.01.14
14 cm/5 1/2"

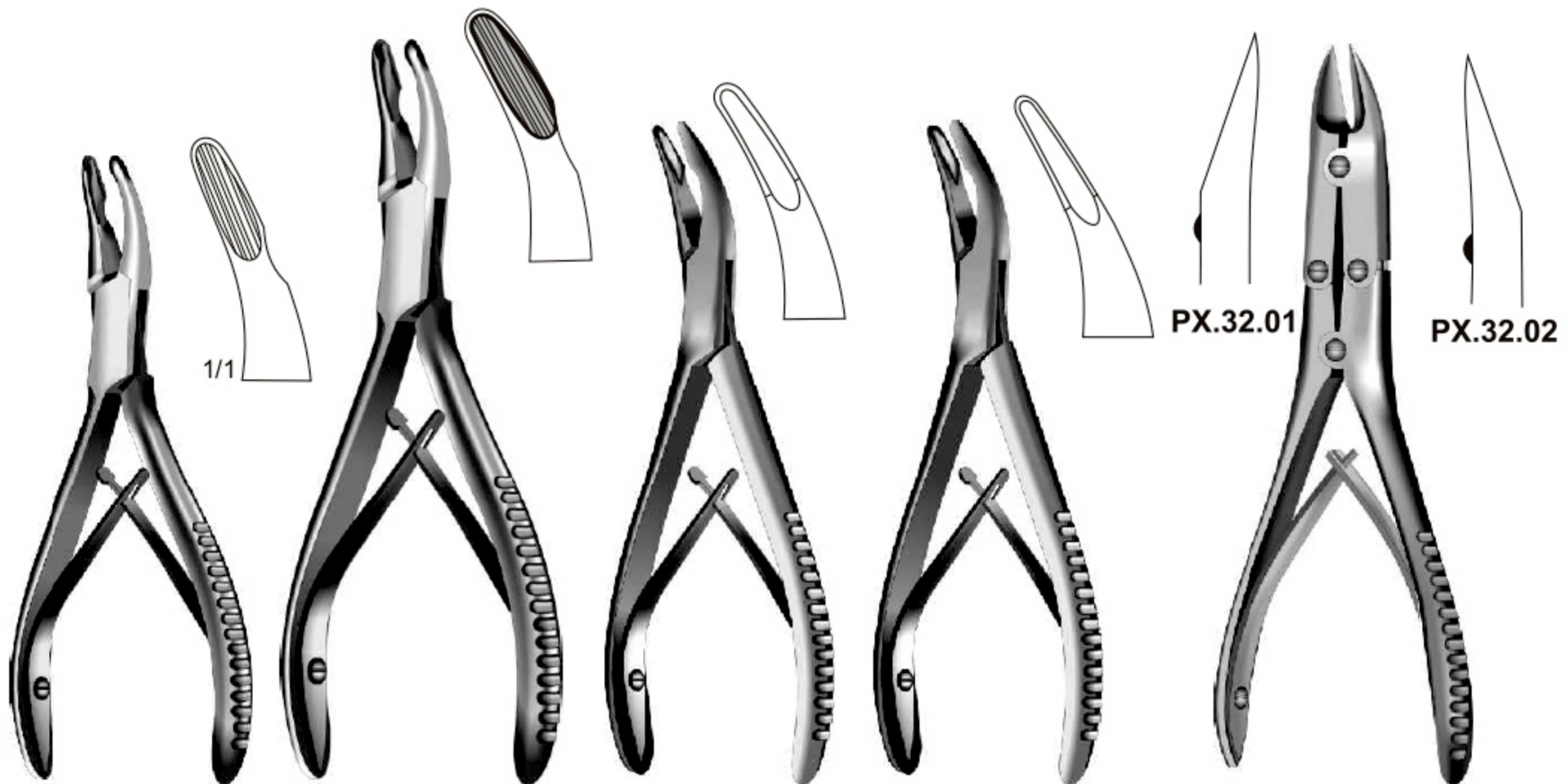

Cleveland
PX.04.14
14 cm/5 1/2"

Cleveland 4A
PX.04.17
17 cm/6 3/4"

Luer
PX.20.65
15 cm/6"

Luer
PX.20.75
15 cm/6"

Bohler
PX.32.01-PX.32.02
15 cm/6"

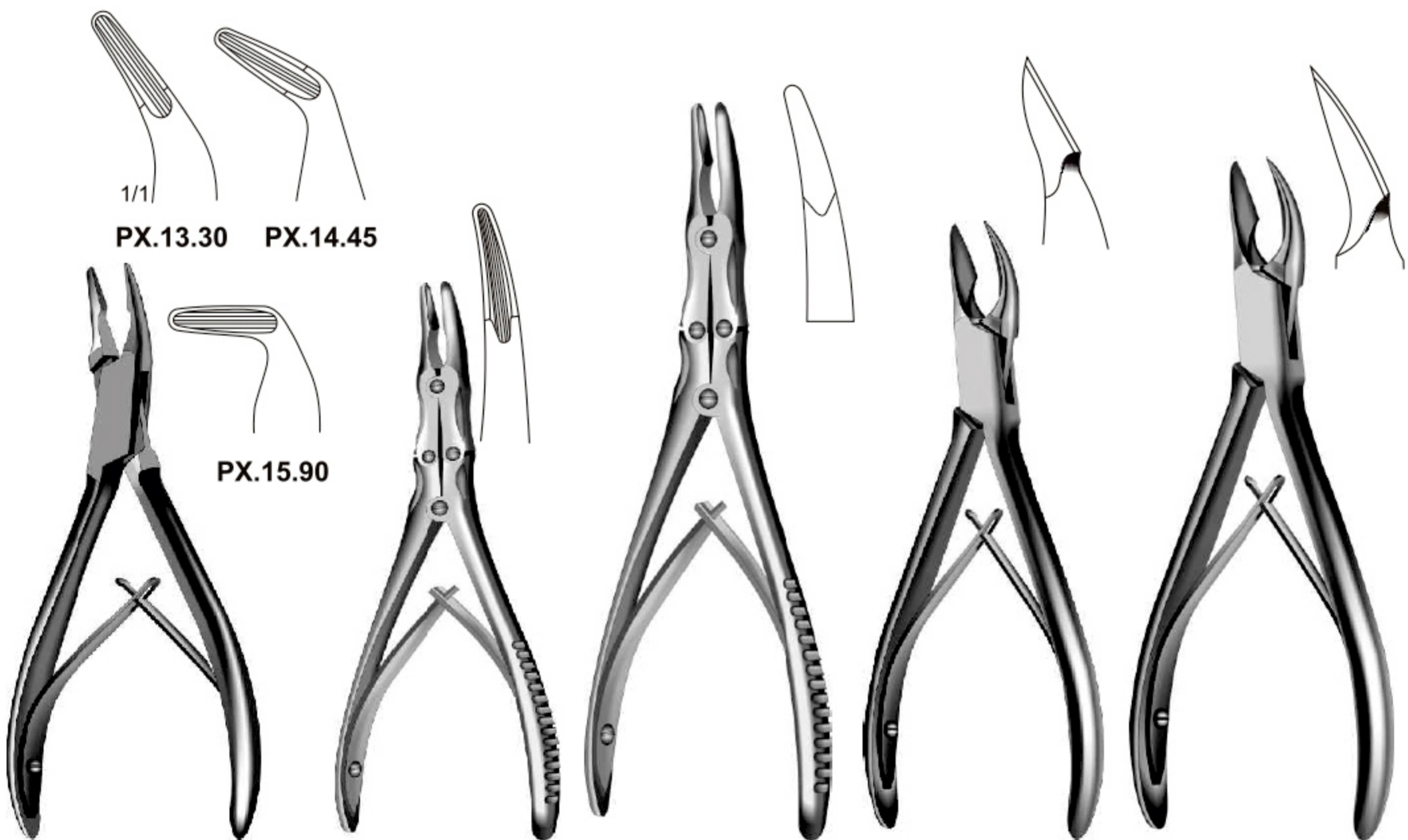

PX.13.30 **PX.14.45**

PX.15.90

Blumenthal
PX.13.30-
PX.15.90
16 cm/6"

Beyer
PX.31.16
15,5 cm/6"

Beyer
PX.31.18
18 cm/7"

Cleveland 5 S
PU.04.14
14cm/5 1/2"

Cleveland 5
PU.05.17
17 cm/6 3/4"

Dermal Punch, Probes, Gauze Packer, Lip Retractor,

- 2 mm ○ PAE.10.62
- 3 mm ○ PAE.10.63
- 4 mm ○ PAE.10.64
- 5 mm ○ PAE.10.65
- 6 mm ○ PAE.10.66
- 7 mm ○ PAE.10.67
- 8 mm ○ PAE.10.68



Keyes
PAE.10.62-
PAE.10.68



Farrell Ø 0.9 mm
PB.16.12 12 cm/ 4 ¾"
PB.16.14 14 cm/ 5 ½"
PB.16.16 16 cm/ 6 ¼"



Bowmann
PAB.94.00
Set of 4
PAB.94.01 Fig 1+2
PAB.94.03 Fig 3+4
PAB.94.05 Fig 5+6
PAB.94.07 Fig 7+8



Ø 1.5 mm	Ø 2 mm	
PB.01.10	PB.02.10	11 cm/ 4 ¼"
PB.01.13	PB.02.13	13 cm/ 5"
PB.01.14	PB.02.14	14 cm/ 5 ½"
PB.01.16	PB.02.16	16 cm/ 6 ¼"



Luniatchek
PAK.30.19
19 cm/7 ½"

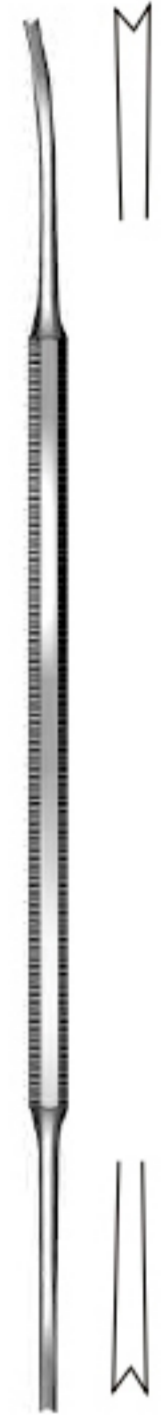

Luniatchek
PAK.30.20
19 cm/7 ½"



Sternberg
PAS.03.15
14 cm/5 ½"

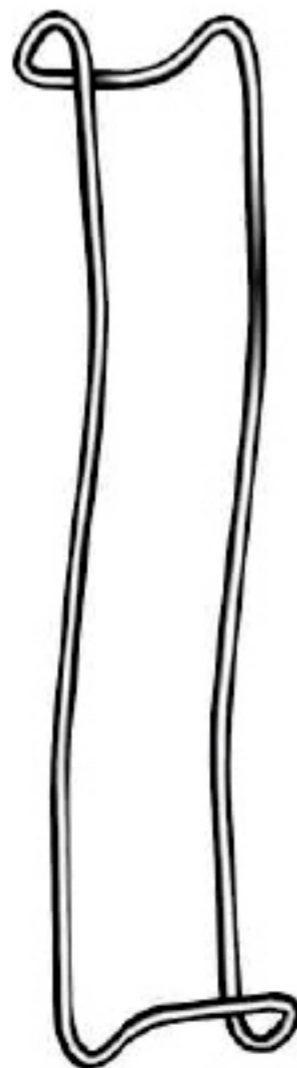

Sternberg
PAS.03.16
16 cm/6 ¼"



Bruenings
PAS.05.18
19 cm/7 ½"



PAS.03.16
Wood
16 cm/ 6 ¼"



Kroenig
PAS.03.14
15 cm/6"



Mayo
PAS.04.17
17 cm/6 ¼"

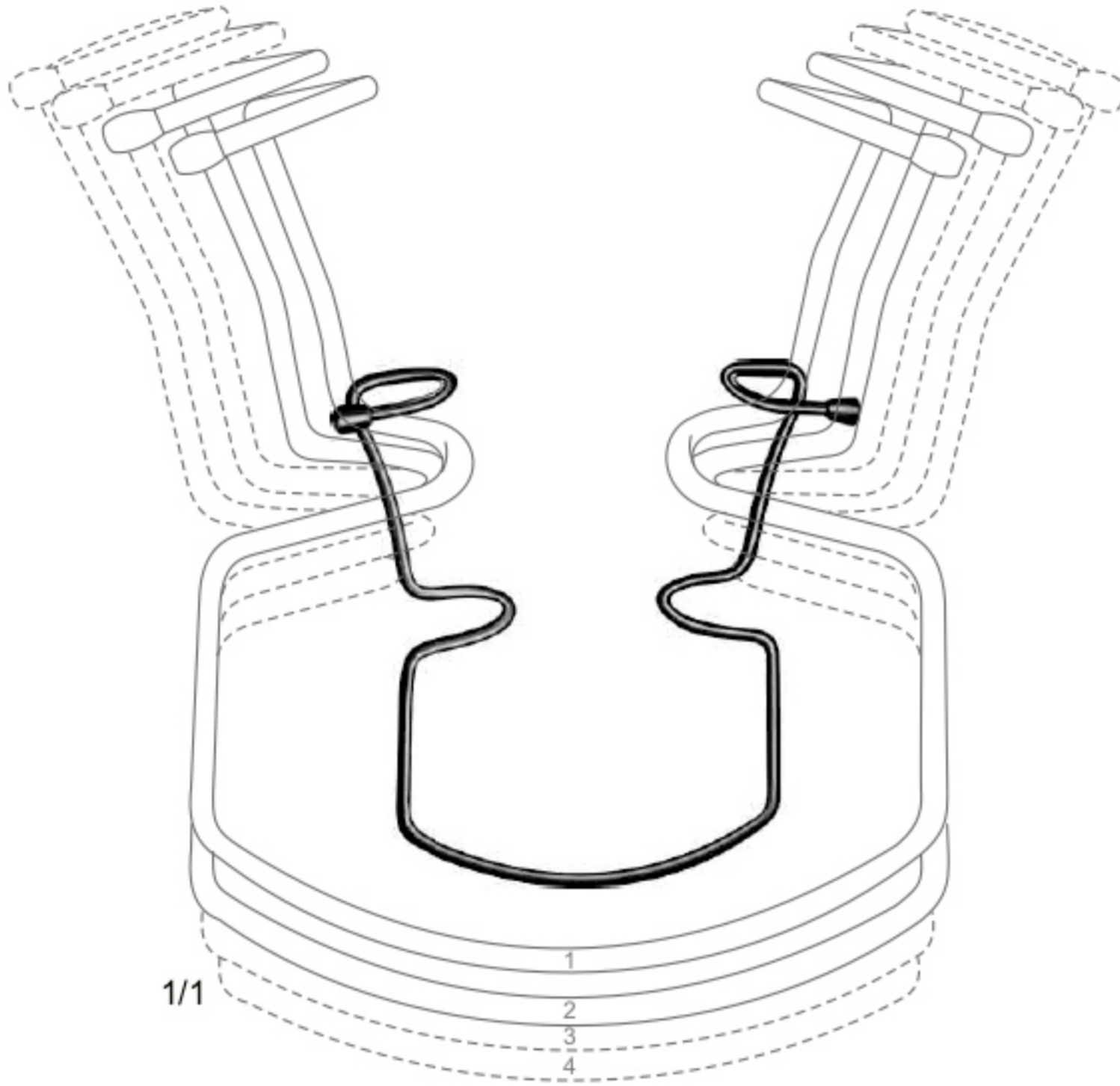

Oringer
PAQ.01.00 Fig.1
PAQ.01.02 Fig.2
PAQ.01.03 Fig.3
PAQ.01.04 Fig.4
PAQ.01.13 Set of 4

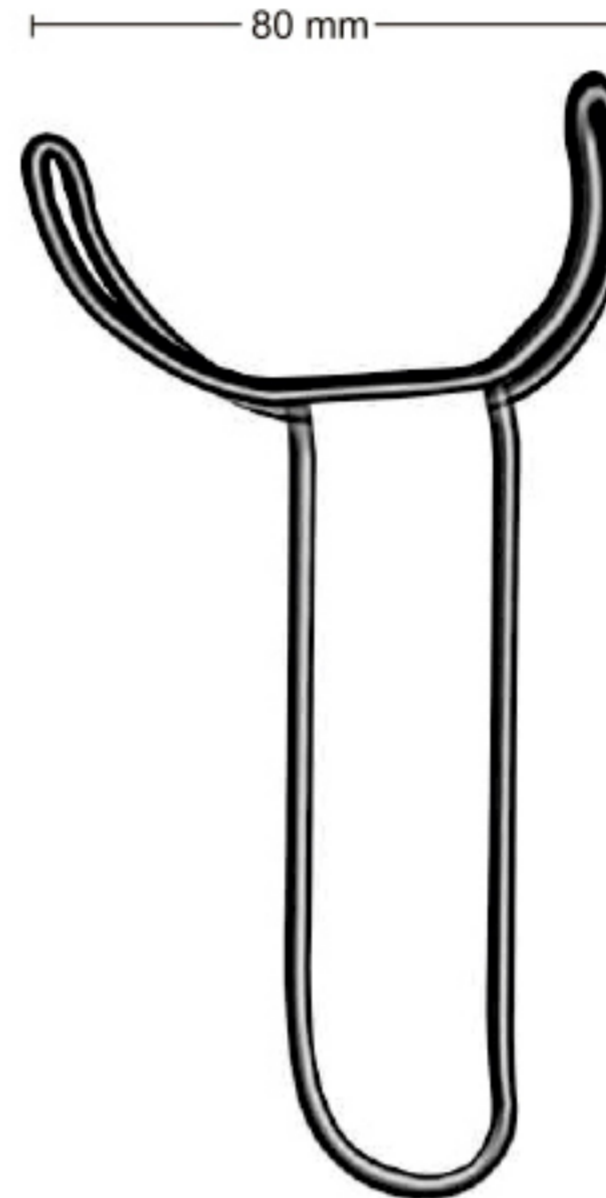

Vestibelum-Haken
PAQ.01.15
 15cm/ 6"



Heister
PAQ.05.05
 13 cm/ 5"

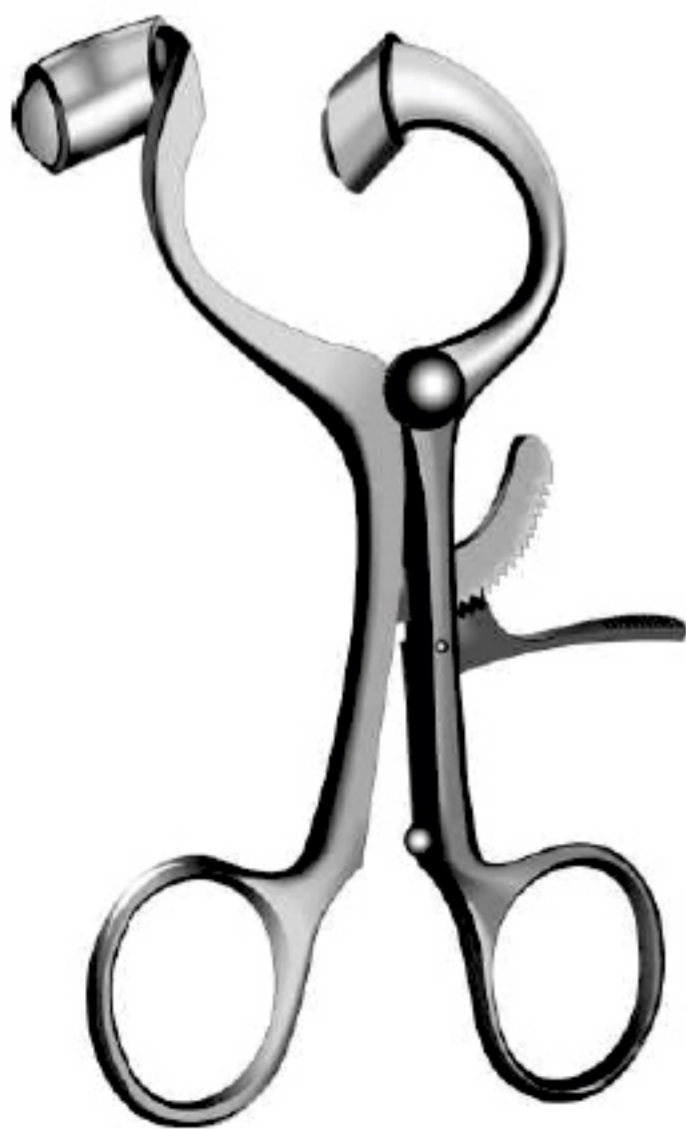

Molt
PAQ.07.15
 15cm/6"



Jennings
PAQ.09.09 9 cm/ 3 ½"
PAQ.09.11 11 cm/ 4 ¼"
PAQ.09.13 13 cm/ 5"
PAQ.09.15 15 cm/ 6"



Roser-Konig
PAQ.13.45 16 cm/6 ¼"
PAQ.13.50 20 cm/7 ½"



Denhart
PAQ.14.60
 13 cm/5"

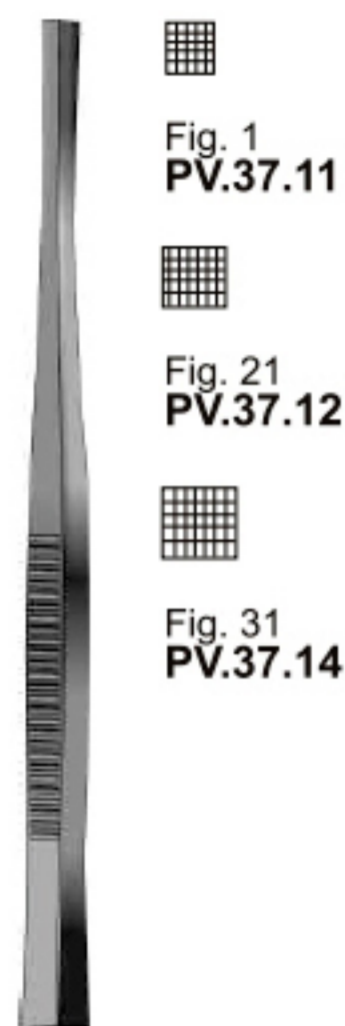

Passow
PV.37.11-
PV.37.14
 12 cm/ 4 3/4"

- Fig. 1
PV.37.11
- Fig. 21
PV.37.12
- Fig. 31
PV.37.14



Parsch
 13,5 cm/5 1/2" 17 cm/6 3/4"



Parsch
 13,5 cm/5 1/2" 17 cm/6 3/4"

	13,5 cm/5 1/2"		17 cm/6 3/4"	
3 mm	PV.05.03	PV.05.53	PV.06.03	PV.06.53
4 mm	PV.05.04	PV.05.54	PV.06.04	PV.06.54
5 mm	PV.05.05	PV.05.55	PV.06.05	PV.06.55
6 mm	PV.05.06	PV.05.56	PV.06.06	PV.06.56



Cottle
PAN.28.04-
PAN.28.12

- 4 mm
PAN.28.04
- 7 mm
PAN.28.07
- 12 mm
PAN.28.12

- PW.14.24** Fig.0000
- PW.14.33** Fig.000
- PW.14.42** Fig.00
- PW.14.50** Fig.0
- PW.14.51** Fig.1
- PW.14.52** Fig.2
- PW.14.53** Fig.3
- PW.14.54** Fig.4
- PW.14.55** Fig.5
- PW.14.56** Fig.6



Volkmann
PW.14.22-PW.14.56
 17 cm/6 3/4"

- Fig.0000 Fig.000 Fig.00
- Fig.0 Fig.1 Fig.2
- Fig.3 Fig.4
- Fig.5 Fig.6



Williger
PW.21.10-
PW.21.12
 13,5 cm/5 1/4"

- PW.21.10**
- PW.21.11**
- PW.21.12**

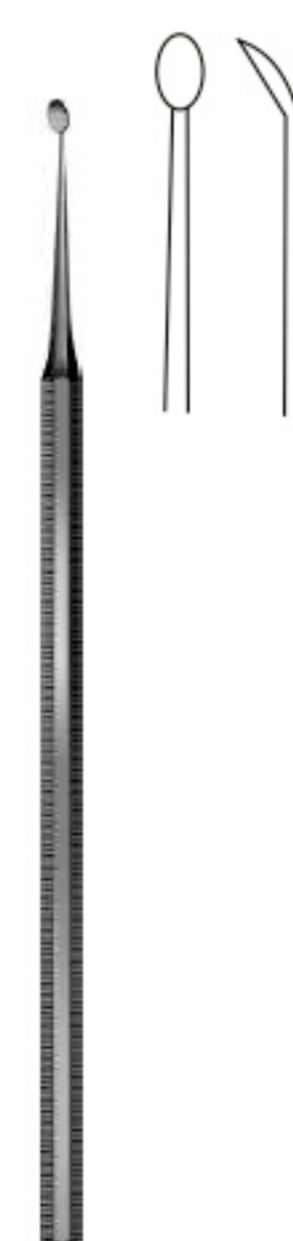

Parsch
PW.30.15
 15 cm/6"

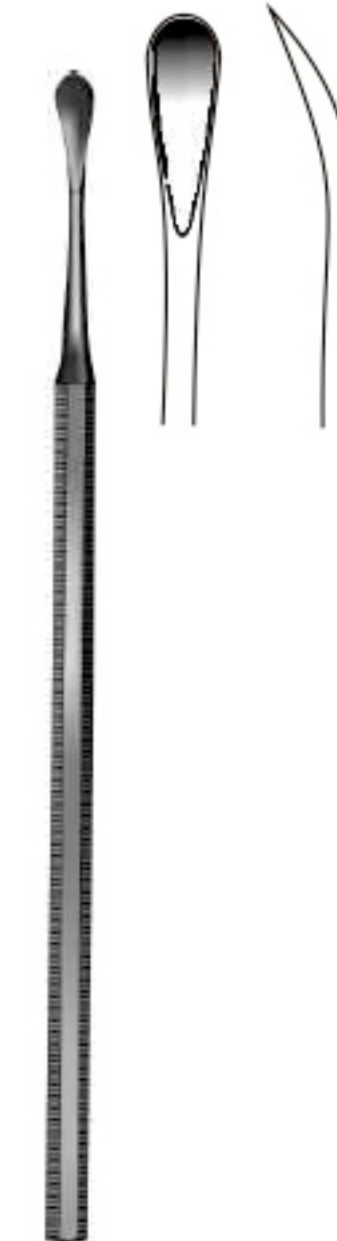

Parsch
PW.31.15
 15 cm/6"

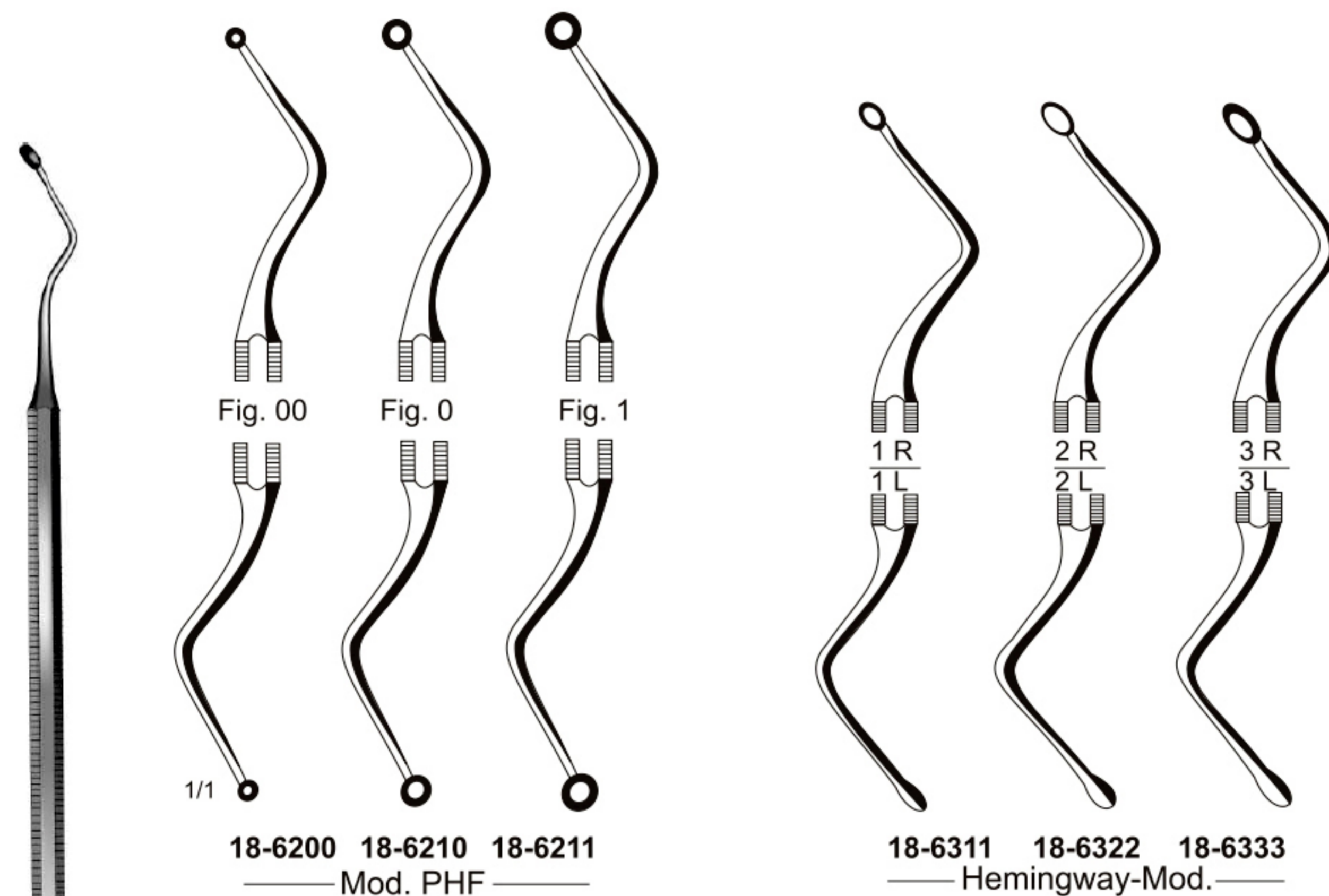

18-6200-18-6211
18-6311-18-6333



20 mm Ø
150 g (5¼ oz.)
Lead filled

PM.01.16
16,5 cm/ 6½"



30 mm Ø
220 g (7¾ oz.)

Collin
PM.05.20
20 cm/ 8"



26 mm Ø
320 g (5¼ oz.)

With interchangeable
ferrozell faces
fiber
18cm

Mead
PM.06.19
Massive - solid
17 cm/ 6¾"

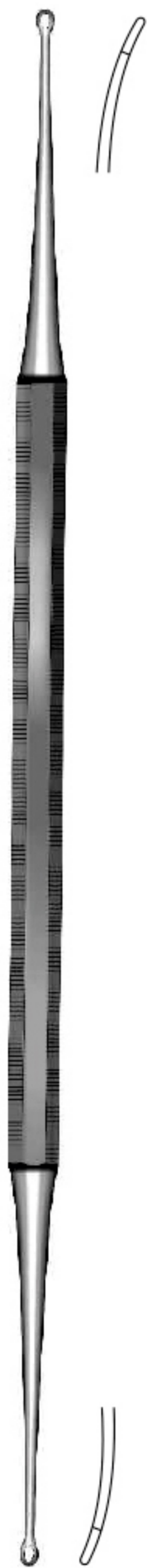

18-6401



1/2

Miller-Colburn
18-6411 - 18-6444



1/1

18-6411

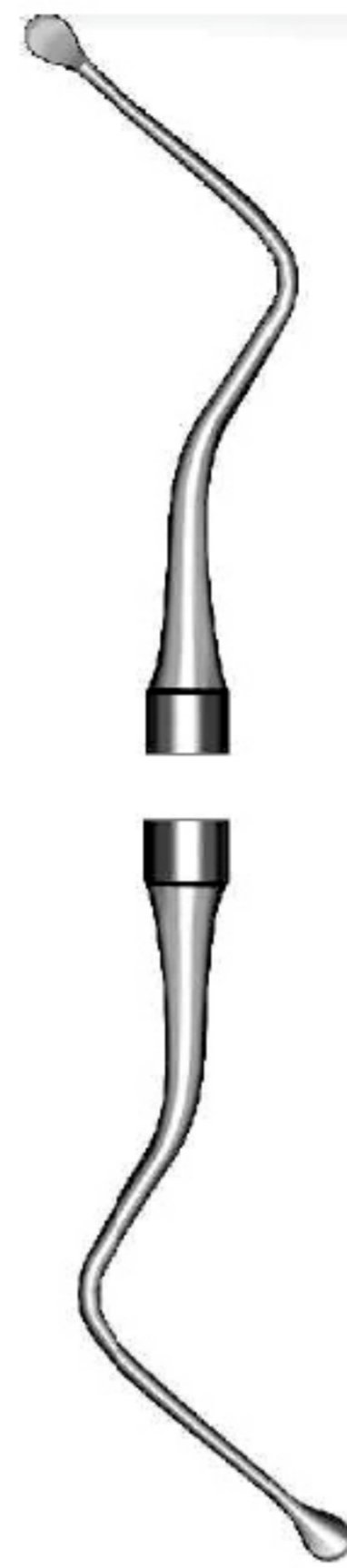

18-6422

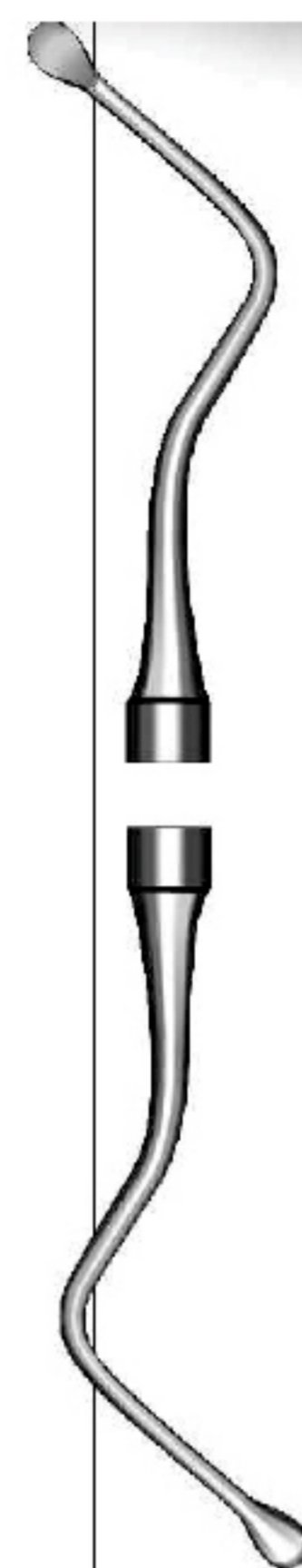

18-6433

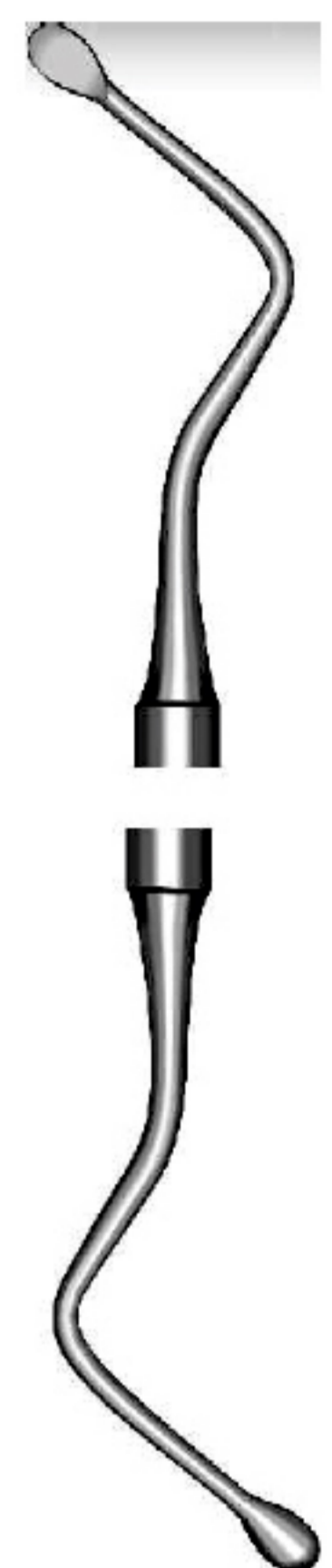

18-6444

Miller-Colburn



Lucas
18-6501 - 18-6504

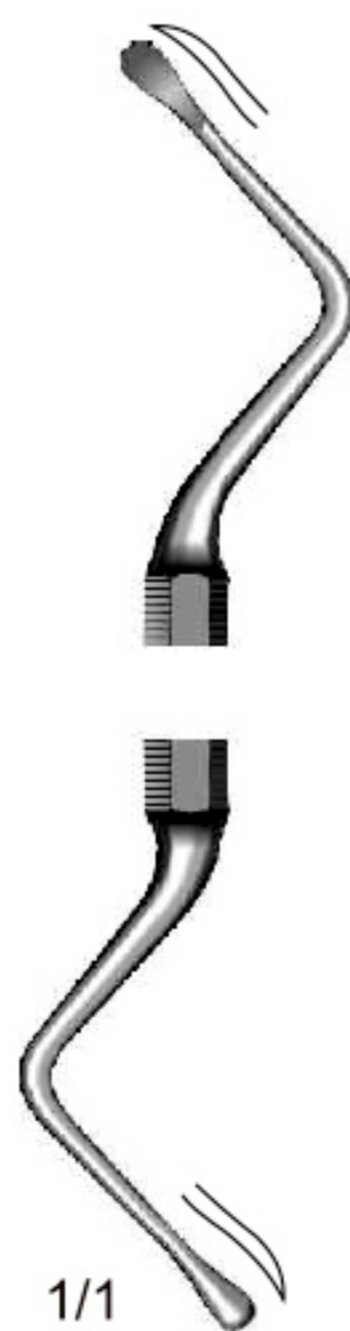

1/1

18-6501



18-6502

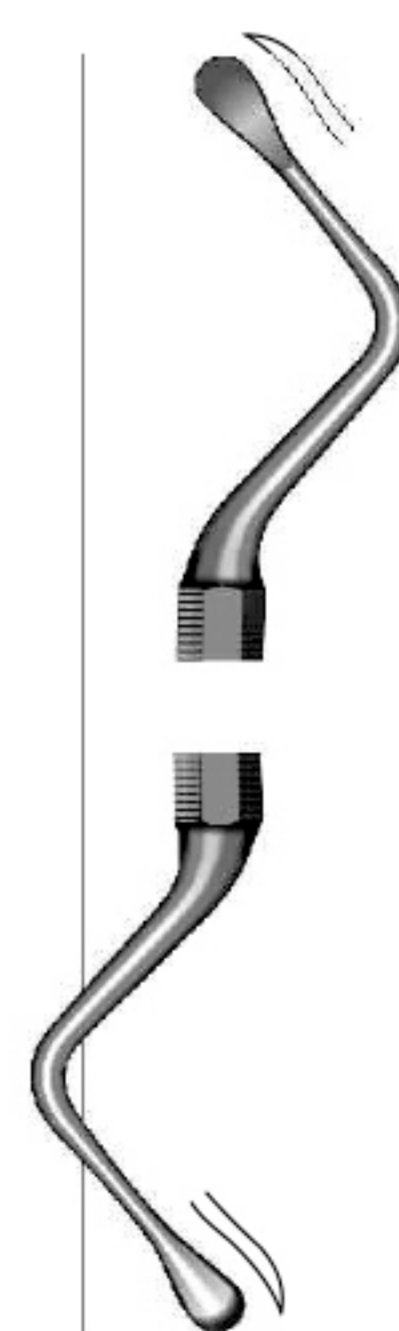

18-6503



18-6504

Lucas

Tongue Depressors / Mouth Gags / Tongue Holding

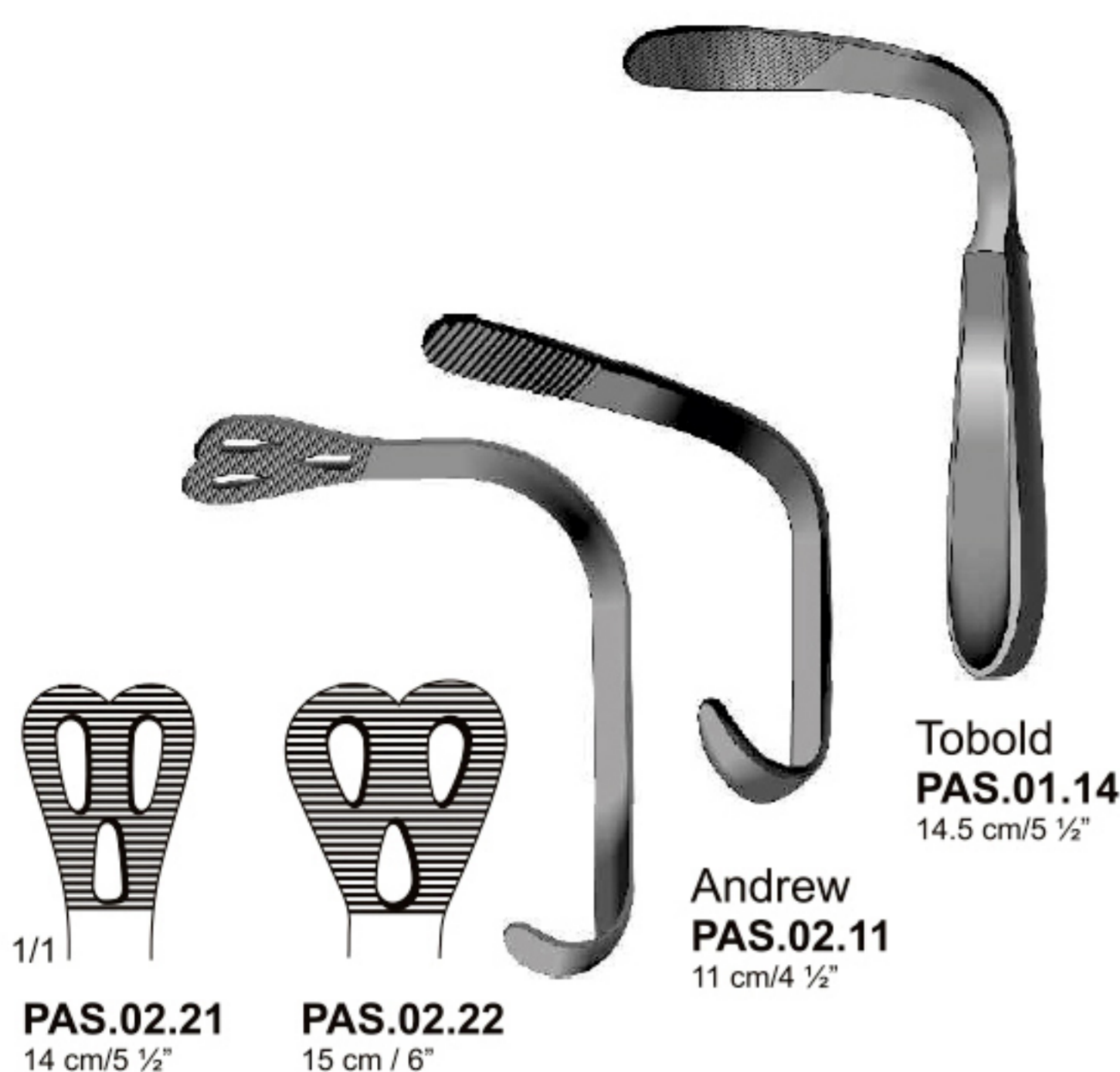

PAS.02.21
14 cm / 5 1/2"

PAS.02.22
15 cm / 6"

Andrew
PAS.02.11
11 cm / 4 1/2"

Tobold
PAS.01.14
14.5 cm / 5 1/2"

Wieder
PAS.02.21-
PAS.02.22



Collin
PAD.14.17
17 cm / 6 3/4"



Guy
PAD.15.36
16 cm / 6 1/4"

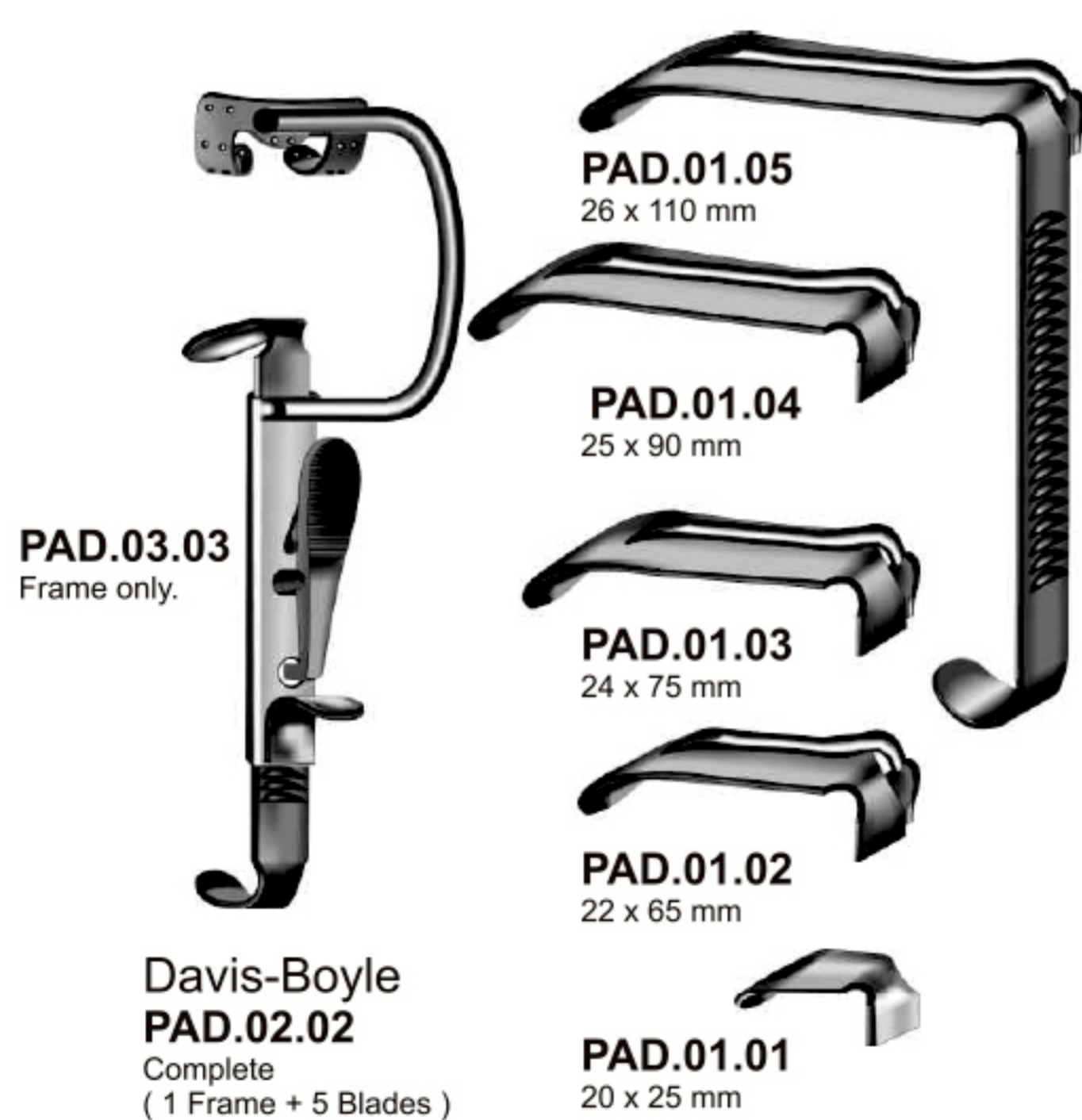

PAD.03.03
Frame only.

Davis-Boyle
PAD.02.02
Complete
(1 Frame + 5 Blades)

PAD.01.05
26 x 110 mm

PAD.01.04
25 x 90 mm

PAD.01.03
24 x 75 mm

PAD.01.02
22 x 65 mm

PAD.01.01
20 x 25 mm



PAD.06.01
(Frame only)

McIvor
PAD.07.00
Complete
(1 Frame + 3 Blades)



PAD.08.03
26 x 100 mm

PAD.08.02
25 x 86 mm

PAD.08.01
23 x 70 mm

Needle Cases



PR.15.05 = 50 x 25 x 4,5 mm
PR.15.08 = 65 x 42 x 8 mm
PR.15.06 = 75 x 25 x 4,5 mm

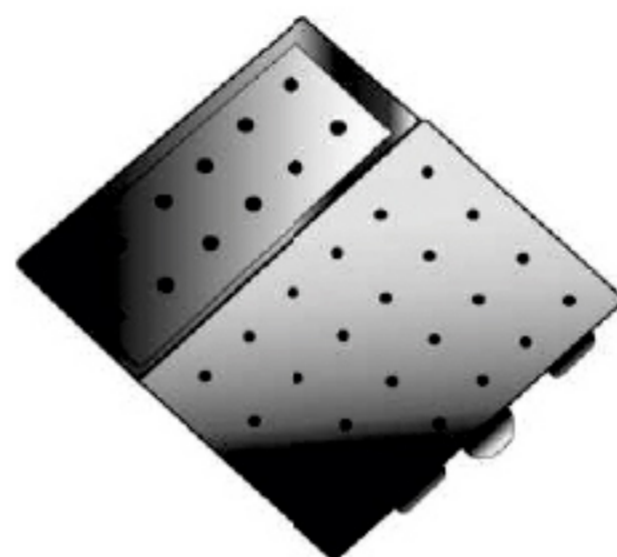

PR.16.05 = 50 x 25 x 4,5 mm
PR.16.08 = 65 x 42 x 8 mm
PR.16.06 = 75 x 25 x 4,5 mm

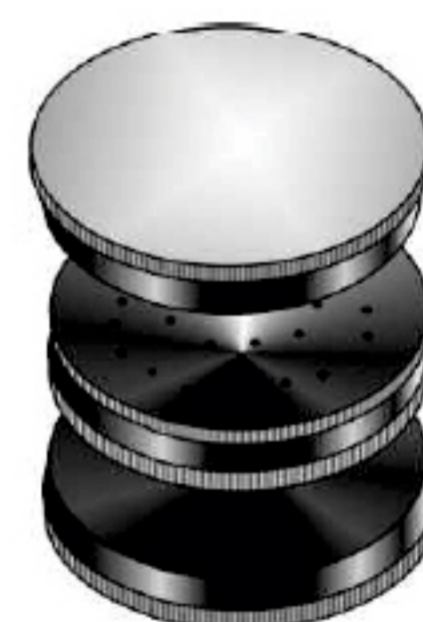

Trays



PAF.05.63
 235 x 190 x 40 mm

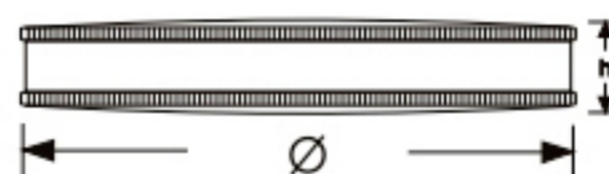

complete	insert only
PR.19.65	PR.19.70
Ø = 65 mm	Ø = 62 mm
h = 15 mm	h = 13 mm

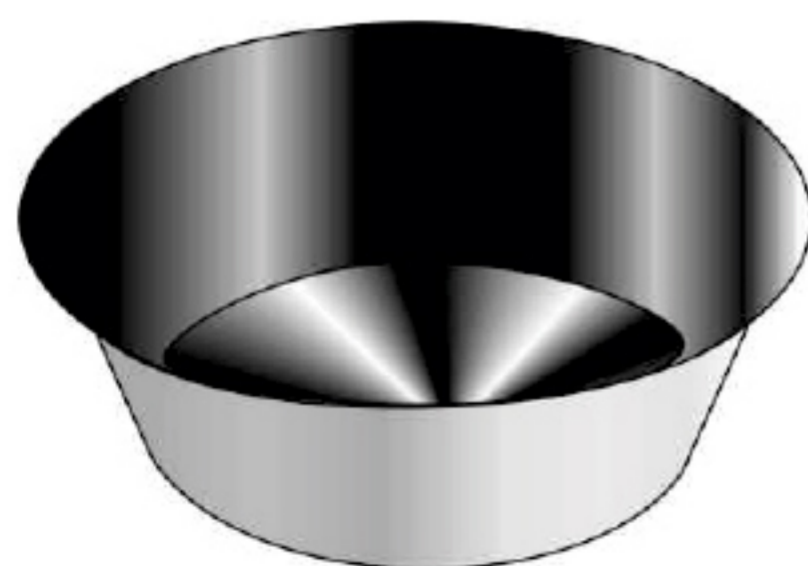

PAF.05.82
 Ø 200 x 70 mm

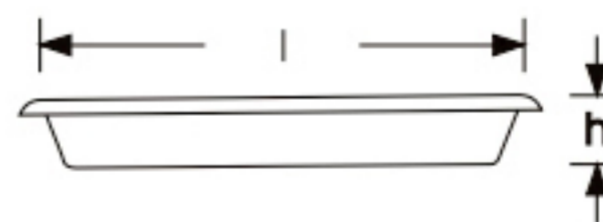
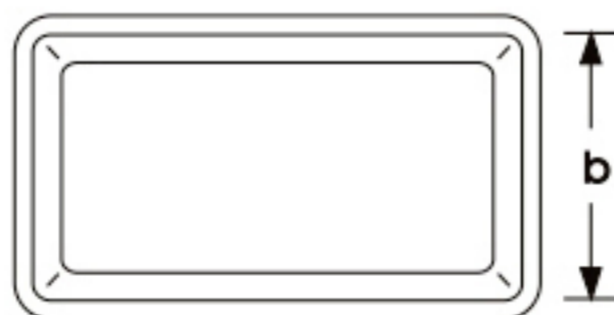

	l	b	h
PAF.04.20	200	150	38 mm
PAF.04.25	250	200	50 mm
PAF.04.30	300	250	50 mm
PAF.04.35	355	305	50 mm
PAF.04.40	405	305	50 mm



PAF.04.20- PAF.04.40

Forceps Jars



Size in mm Ø X h	Jar without lid	Jar with lid
30 x 90	PAF.15.30	PAF.15.54
50 x 100	PAF.15.50	PAF.15.55
50 x 130	PAF.15.51	PAF.15.56
50 x 175	PAF.15.52	PAF.15.57
75 x 100	PAF.15.75	PAF.15.80
75 x 130	PAF.15.76	PAF.15.81
75 x 175	PAF.15.77	PAF.15.82
100 x 175	PAF.15.98	PAF.15.88
100 x 200	PAF.15.99	PAF.15.89

Instrument Box



PAF.20.20
205 x 105 x 40 mm

Kidney Trays



Size in mm l x b x h	Product Code	Size in cm/in
170 x 100 x 35	PAF.10.17	17 cm/ 6 3/4"
250 x 140 x 40	PAF.10.25	25 cm/ 10"
275 x 150 x 45	PAF.10.27	27 cm/ 10 3/4"

Instrument Boxes



Size in mm			
L	w	h	
165 x	85 x	35	PAF.21.46
200 x	100 x	35	PAF.21.50
200 x	100 x	50	PAF.21.51
230 x	130 x	50	PAF.21.53
260 x	150 x	50	PAF.21.56
<hr/>			
270 x	235 x	50	PAF.21.57
300 x	200 x	50	PAF.21.60
325 x	275 x	30	PAF.21.62
325 x	275 x	50	PAF.21.63
420 x	80 x	40	PAF.21.72
<hr/>			
420 x	175 x	50	PAF.21.75

Cotton Dispensers



Methot
PAF.35.01 **PAF.35.02**
 ø50 x 75 mm
 With lid Without lid



Spirit Lamp
19-1505
 120 cc

Cotton wool containers



Size in mm	Lid with knob
ø X h	
75 x 60	PAF.08.07
75 x 75	PAF.08.08
100 x 60	PAF.08.10
100 x 100	PAF.08.11
125 x 80	PAF.08.12
125 x 125	PAF.08.13
150 x 100	PAF.08.14
150 x 150	PAF.08.15
200 x 100	PAF.08.20
200 x 150	PAF.08.21
200 x 200	PAF.08.22
240 x 160	PAF.08.24
240 x 230	PAF.08.25
290 x 160	PAF.08.29
290 x 240	PAF.08.30

Sterilization Drums



Schimmelbusch
(Horizontal Ventilation)

Ø	h	
140 x 140 mm		PR.25.14
160 x 150 mm		PR.25.16
190 x 160 mm		PR.25.19
190 x 190 mm		PR.25.20
240 x 120 mm		PR.25.24
240 x 160 mm		PR.25.25
240 x 240 mm		PR.25.27
290 x 160 mm		PR.25.29
290 x 240 mm		PR.25.30
340 x 160 mm		PR.25.34
340 x 240 mm		PR.25.35
390 x 140 mm		PR.25.39
390 x 190 mm		PR.25.40
390 x 290 mm		PR.25.41



Konrich
(Vertical Ventilation)

Ø	h	
140 x 140 mm		PR.26.14
160 x 150 mm		PR.26.16
190 x 160 mm		PR.26.19
190 x 190 mm		PR.26.20
240 x 120 mm		PR.26.24
240 x 160 mm		PR.26.25
240 x 240 mm		PR.26.27
290 x 160 mm		PR.26.29
290 x 240 mm		PR.26.30
340 x 160 mm		PR.26.34
340 x 240 mm		PR.26.35
390 x 140 mm		PR.26.39
390 x 190 mm		PR.26.40
390 x 290 mm		PR.26.41

Norm Trays

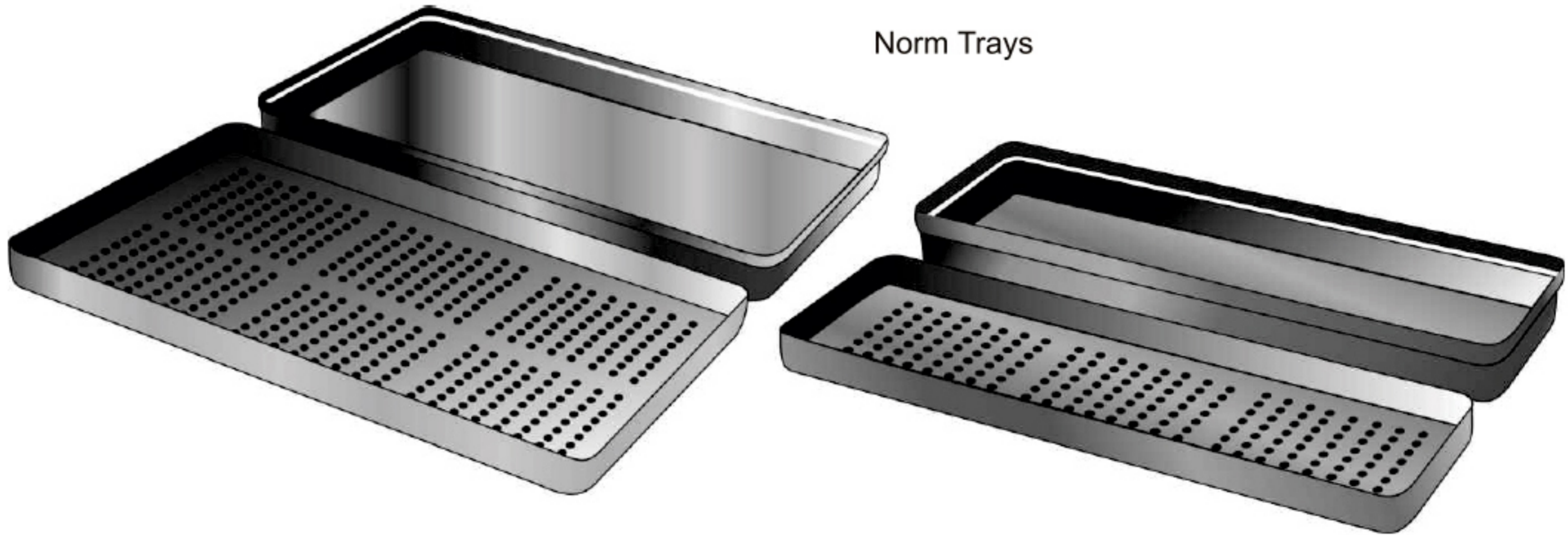

19-2101 - 19-2104
288 x 187 x 40 mm

19-2201 - 19-2204
288 x 93 x 40 mm

	Tablet	Lid	
19-2101	Perforated	Unperforated	19-2201
19-2102	Unperforated	Unperforated	19-2202
19-2103	Perforated	Perforated	19-2203
19-2104	Unperforated	Perforated	19-2204

Inserts for Trays

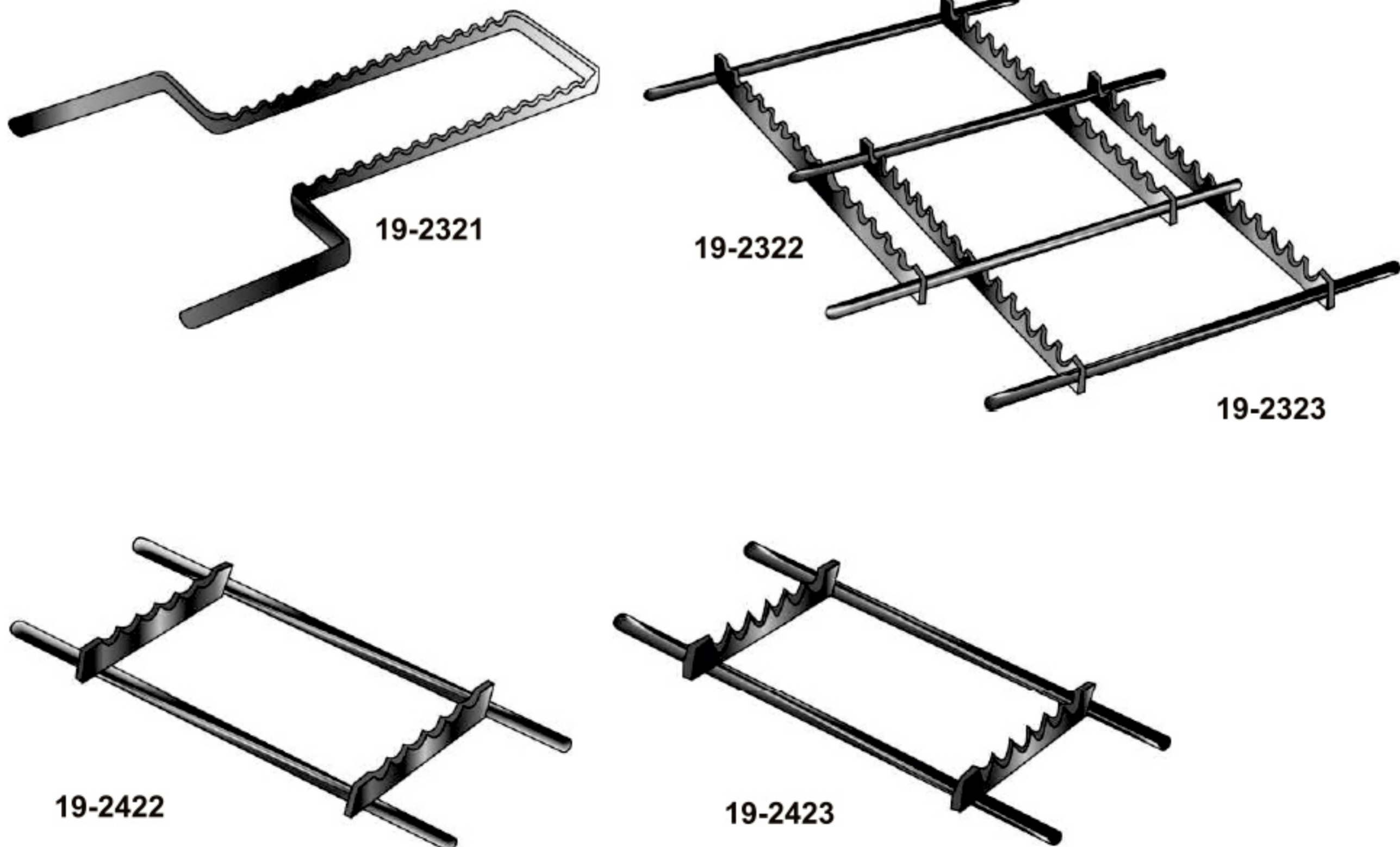



CH 20

Surgery



Suction Tubes

With additional side holes

- | | | | |
|---|------------------------------|---|------------------------------|
|  | ○ 20-0201
1,5 mm Ø |  | ○ 20-0205
1,5 mm Ø |
| | ○ 20-0202
2,0 mm Ø | | ○ 20-0206
2,0 mm Ø |
| | ○ 20-0203
2,5 mm Ø | | ○ 20-0207
2,5 mm Ø |
| | ○ 20-0204
3,5 mm Ø | | ○ 20-0208
3,5 mm Ø |

6 mm round

6 mm oval



Nuboer
20-0121
21 cm/8½"

Nuboer
20-0122
21 cm/8½"

Coupland
20-0217
17 cm/ 6 ¾"

Byrd
20-0301-
20-0303
20 cm/ 8"

Cogswell
20-0423
23 cm/ 9"

Adson
PB.39.32
4 mm
21 cm/ 8 ½"

Frazier
Charr. / Fr.
PB.36.86 6
PB.36.88 8
PB.36.90 10
PB.36.92 12
19 cm/ 7 ½"

Yankauer
PB.30.00
27 cm/ 11"

Cartridge / Water Syringes



20-0702-1.8cc
20-0703-2.2cc
(Complete with 2 tips)



20-0801



20-0802



20-0803



20-0804



20-0805



20-0900
1,8 ml



20-0806

Chiropody Instruments

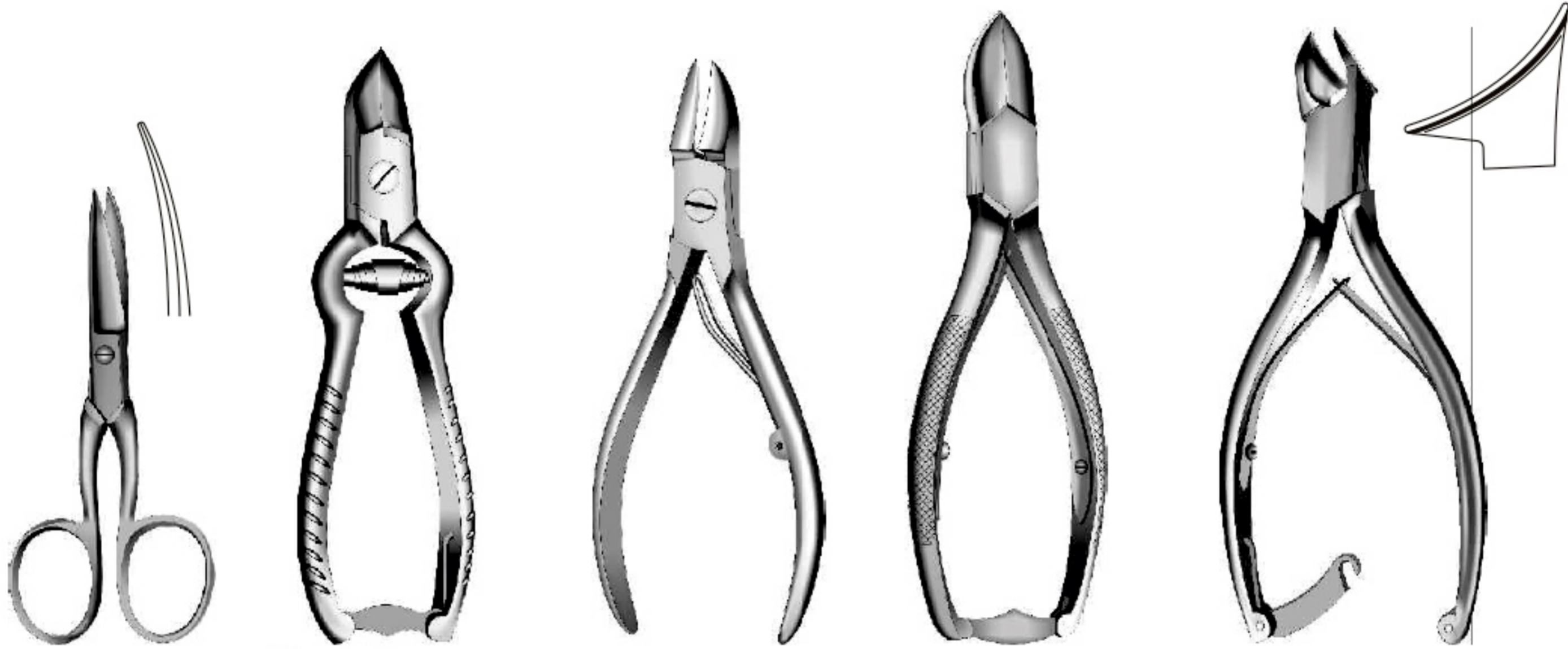

PAR.04.10
10 cm / 4"

Turnbull
PAR.07.81 = 11.5 cm / 4 1/2"
PAR.07.83 = 13 cm / 5"

PAR.08.13
13 cm / 5"

PAR.09.14 = 14 cm / 5 1/2"
PAR.09.16 = 16 cm / 6 1/4"

PAR.10.84
14 cm / 5 1/2"

Sterilization Forceps



Cheatle
PR.03.27
27 cm / 10 1/2"

PAD.19.30
30 cm / 12"

Spatulas



20-1919 = 19 cm / 7 1/2"
20-1922 = 22 cm / 8 1/2"
20-1925 = 25cm / 10"

20-2021
21 cm / 8 1/4"
105 x 30 mm
elastic

20-2120
20 cm / 8"
100 x 23 mm
rigid

20-2219
19 cm / 7 1/2"
100 x 17 mm
elastic

Napkin Holders



Professional
20-2301
length adjustable



Adams
20-2302

Finger Guards



20-2401



20-2402



20-2403

Langenbeck
20-2401 - 20-2403

Sand glass

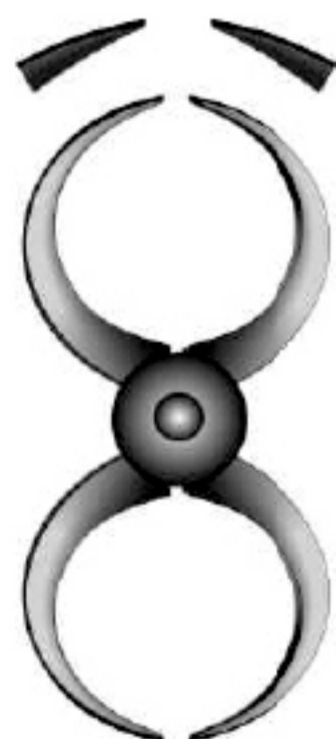

20-2500

Spring Caliper



20-2601

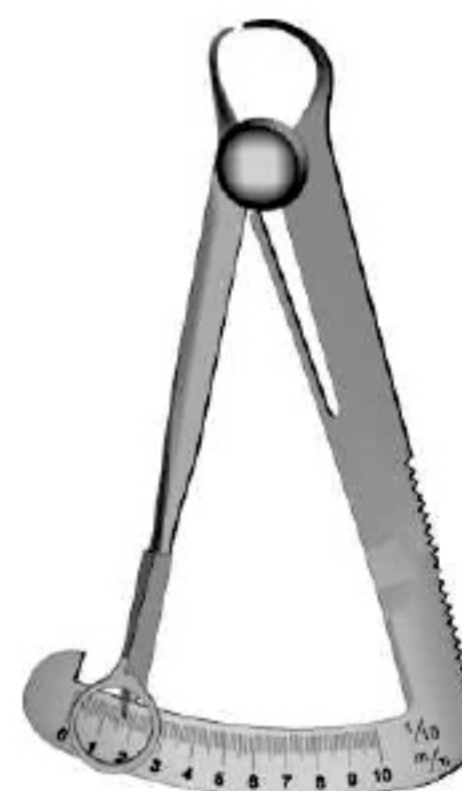

20-2602

Micro meters



Boley
20-2710

0 - 100 mm

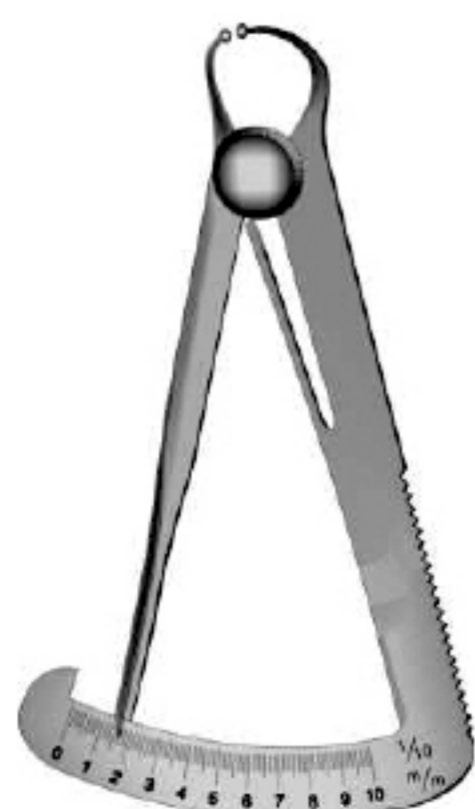

Iwanson
20-2603

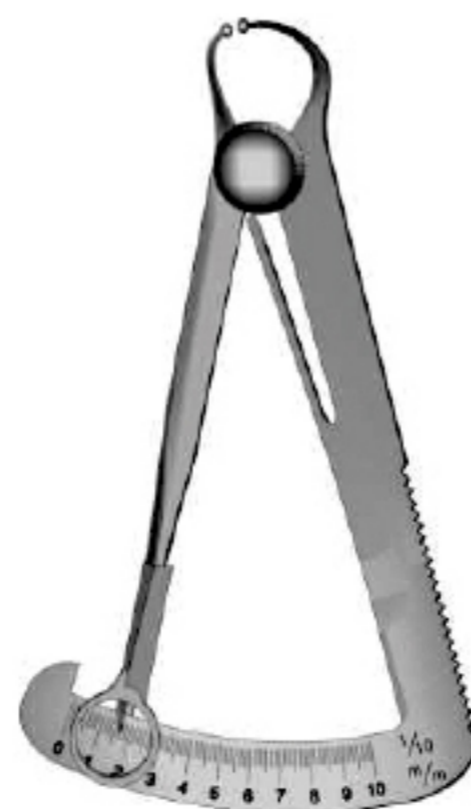

Iwanson
20-2604

Oral wedge



Maunder
PAQ.64.10

Mouth mirrors and handles for mouth mirrors
 Mundspiegel und Mundspiegelgriffe
 Espejos de boca y mango para espejos de boca
 Miroirs à bouche Manche pour miroirs
 Specchietti e manici per specchietti

CH 20

SurgiNOR



Ø mm	Sizes	Plane, Cone-Socket	Magnifying, Cone Socket	Ø mm	Sizes	Plane, simple thread	Magnifying, simple thread
22	4	20-2922	20-3022	22	4	20-3122	20-3222
24	5	20-2924	20-3024	24	5	20-3124	20-3224

Handles for mirrors

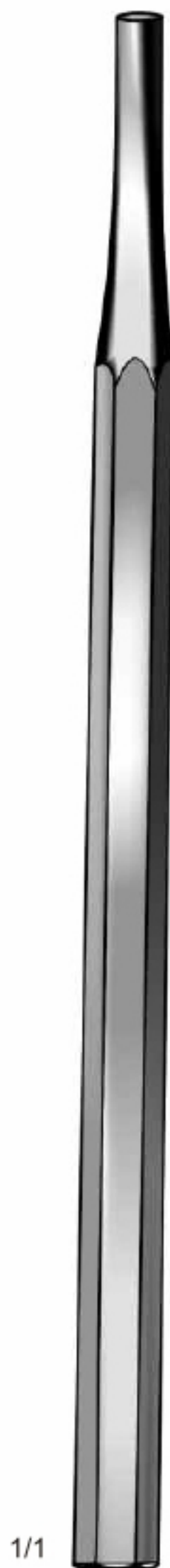

1/1



Secco
20-3401



20-3501



20-3601



20-3701

With simple thread **20-3301**
 With Cone-Socket **20-3302**

CH 21

Dental instruments sets



Supplied in Leather wallets

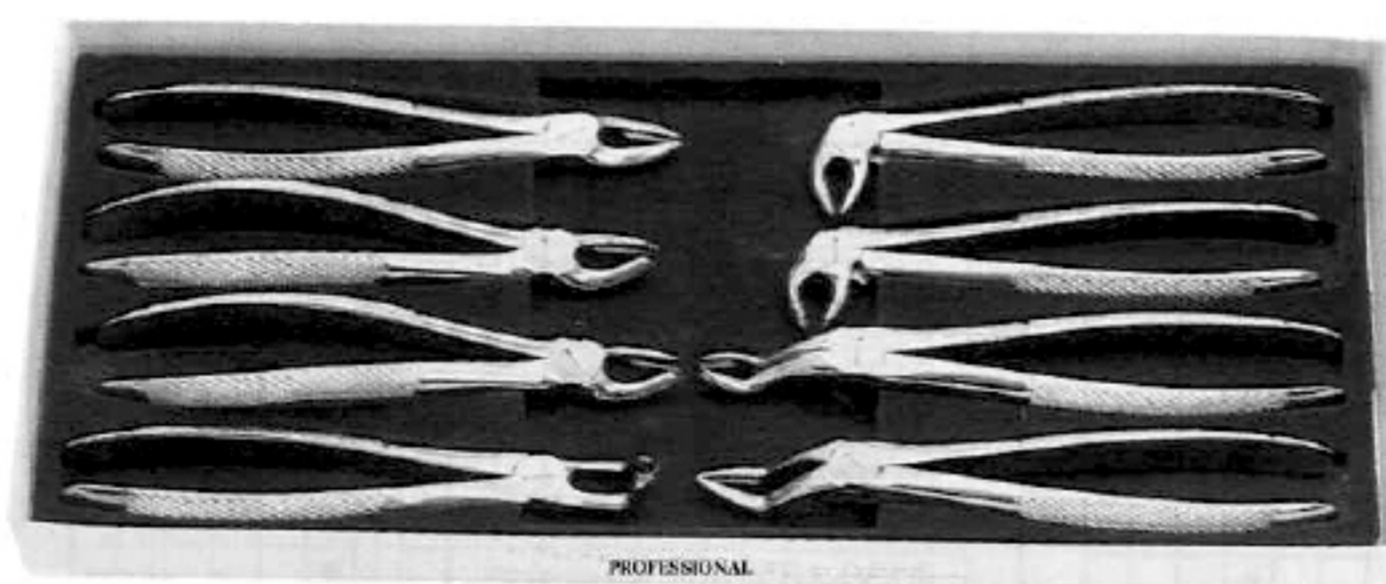

21-0108, Set of 8., Containing

- 01-0101** Dental Extracting Forceps, No.1
- 01-0113** Dental Extracting Forceps, No.13
- 01-0117** Dental Extracting Forceps, No.17
- 01-0118** Dental Extracting Forceps, No.18
- 01-0751** Dental Extracting Forceps, No.51A
- 01-1067** Dental Extracting Forceps, No.67
- 01-1379** Dental Extracting Forceps, No.39

21-0209 Set of 9, Containing

- 01-0333** Dental Extracting Forceps, No.33
- 01-0751** Dental Extracting Forceps, No.51A
- 01-1067** Dental Extracting Forceps, No.67
- 01-1379** Dental Extracting Forceps, No.79
- 05-0203** Root Elevators, 3mm, 13.5 cm/ 5¼"
- 05-2302** Root Elevators, No. 302
- 05-2303** Root Elevators, No. 303
- PJ.69.14** Mayo Hegar Needle Holder, 16 cm, T/C
- PJ.23.56** Mathieu Needle Holder, 14cm, T/C

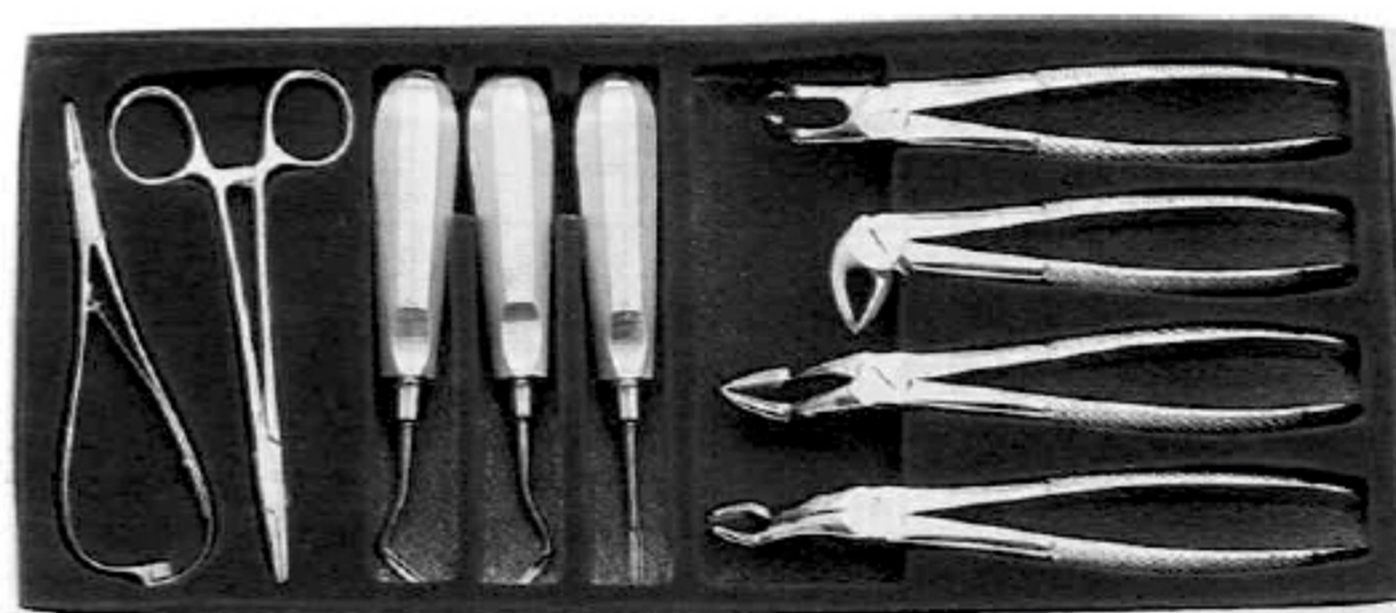

21-0309 Set of 9 , Containing

- 01-0333** Dental Extracting Forceps, No.33
- 01-0751** Dental Extracting Forceps, No.51
- 01-1067** Dental Extracting Forceps, No.67
- 01-1379** Dental Extracting Forceps, No.79
- 05-0203** Root Elevators, 3mm, 13.5 cm/ 5¼"
- 05-2302** Root Elevators, No. 302
- 05-2303** Root Elevators, No. 303
- 05-4320** Dental Extracting Forceps, No.320
- 05-4321** Dental Extracting Forceps, No.321

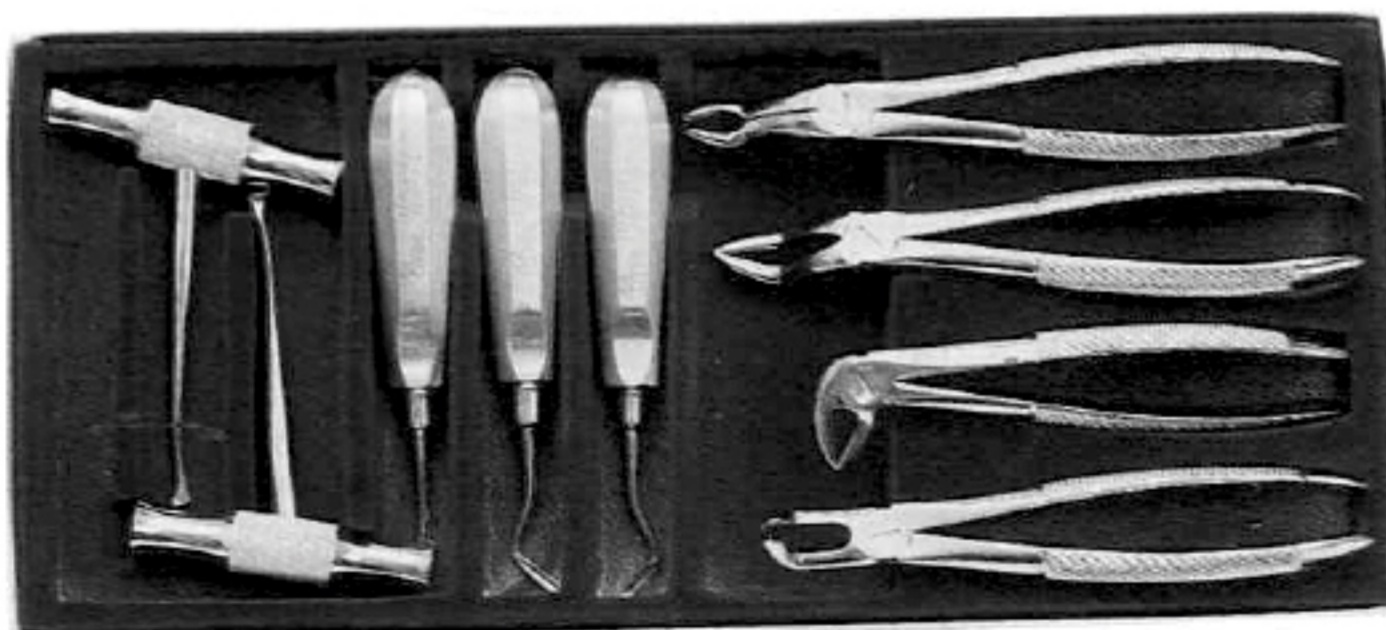

21-0408 Set of 8, Containing

- 01-0101** Dental Extracting Forceps, No.1
- 01-0104** Dental Extracting Forceps, No.4
- 01-0107** Dental Extracting Forceps, No.7
- 01-0113** Dental Extracting Forceps, No.13
- 01-0117** Dental Extracting Forceps, No.17
- 01-0118** Dental Extracting Forceps, No.18
- 01-0220** Dental Extracting Forceps, No.20
- 01-1686** Dental Extracting Forceps, No.6C



Periodontal Instruments Set

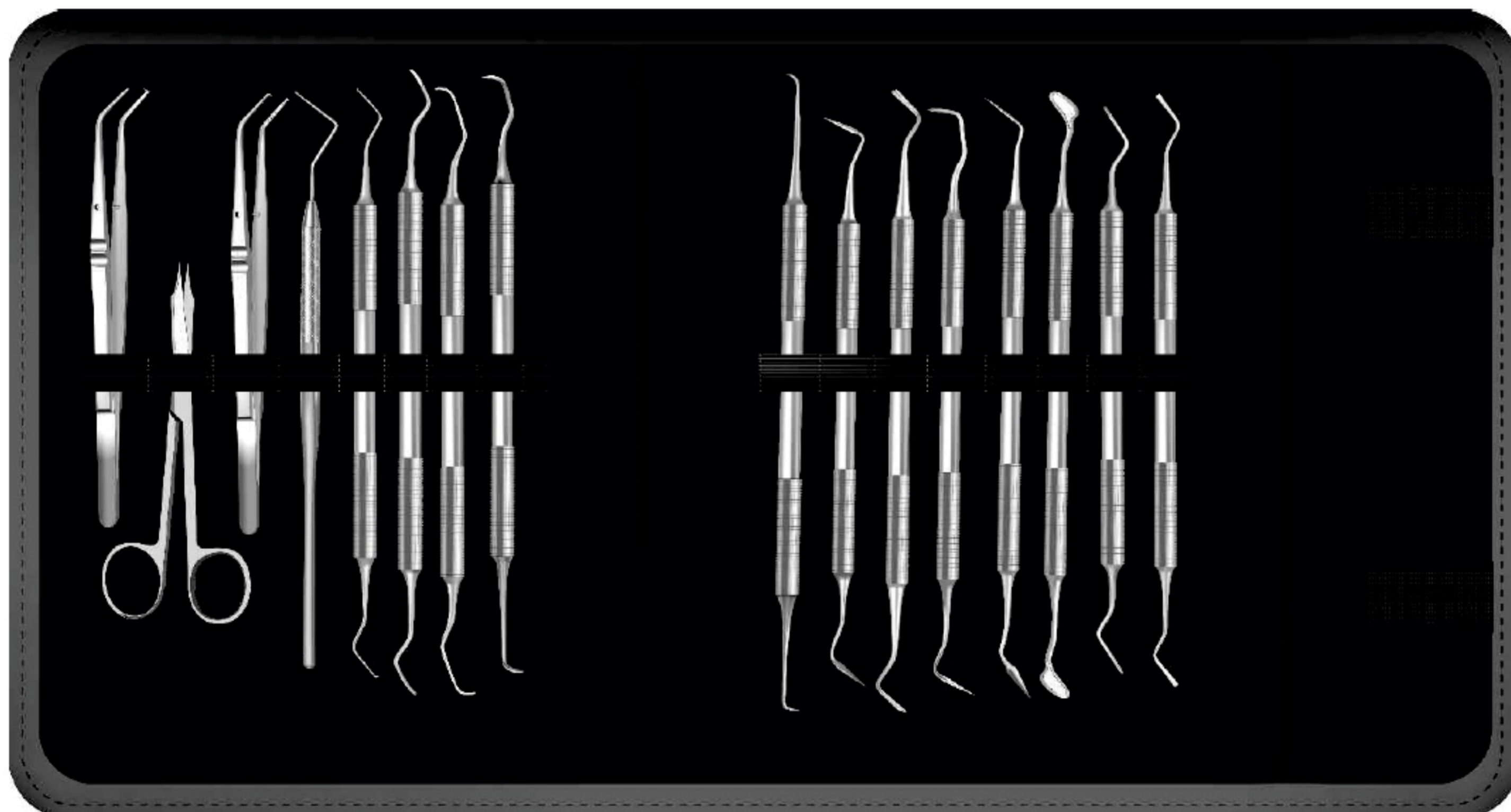

21-0508 Set of 16 Periodontia Instruments, Containing in artificial Leather case :

- 08-2101** Goldman-Fox Curettes 16cm/ 6 1/4"
- 08-2102** Goldman-Fox Curettes 16cm/ 6 1/4"
- 08-2103** Goldman-Fox Curettes 16cm/ 6 1/4"
- 08-2104** Goldman-Fox Curettes 16cm/ 6 1/4"
- 08-2105** Goldman-Fox Curettes 16cm/ 6 1/4"
- 08-2106** Goldman-Fox Curettes 16cm/ 6 1/4"
- 08-1507** Goldman-Fox Knives
- 08-1508** Goldman-Fox Knives
- 08-1509** Goldman-Fox Knives
- 08-1510** Goldman-Fox Knives
- 08-1511** Goldman-Fox Knives
- 08-1521** Goldman-Fox Knives
- PC.90.13** Goldman Fox, Gum Scissors 13 cm/ 5 1/8"
- 15-3301** Crane-Keplan Dental Tweezers 14 cm/ 5 1/2"
- 15-3302** Crane-Keplan Dental Tweezers 14 cm/.5 1/2"

	<i>Page</i>		<i>Page</i>
A		D	
Abell Pliers, Contouring	89	Crane-Kaplan Dental Tweezers	104
Adams Napkin Holders	129	Crane-Kaplan Gingivectomy Knives	51
Adams Pliers, Wire, Arch and Clasp Bending	89,94	Crile-Wood Needle Holders	107
Aderer Pliers, Wire, Arch and Clasp Bending	89,93	Crile-Wood Needle Holders, TC	108
Adson Forceps, Dissecting TC	102	Cross Periodontia Instruments	53
Adson Forceps, Dressing	102	Crown Instruments	71,72
Adson Forceps, Tissue	102	Cryer Extracting Forceps, American Pattern	23
Adson Suction Tubes	126	Cryer Root Elevators	28
Adson-Brown Forceps	102	Cups, Finger	36
Ainsworth Rubber Dam Instruments	74	Curettes, Bone	115-117
Albrecht Dental Tweezers	104	Curettes, Universal	47,48
Allis Forceps, Tissue and Organ Holding	106	Cushing Forceps, Dissecting, TC	102
Allis-Baby Forceps, Tissue and Organ Holding	106	Cutting Instruments	66
Amalgam Instruments	35-37		
Andrew Tongue Depressors	118	D	
Angle Pliers, Wire, Arch and Clasp Bending	89,94	Darby-Perry Excavators	60
Apical Flohr Root Elevators	28	Darby-Perry Scalers	46
Apical Root Elevators	28	Davis-Boyle Mouth Gags	118
Articulating Forceps	104	De La Rosa, Pliers	91
Ash Gum Knives	98	Dean Gum Scissors	100
Ash Plastic Filling Instruments	39	Dean Gum Scissors, TC	101
Axial Filling Instruments	40,41	Decimal Spring Calipers	129
		Denhart Mouth Gag	114
B		Derf Needle Holders, TC	108
Babcock Forceps, Tissue and Organ Holding	106	Diamant End and Side Nipper	89
Baby-Crile Needle Holders	108	Dispenser, Gauze and Cotton	122
Backhaus Towel Forceps	105	Dividing Compasses	129
Barnhart Universal Curettes	48	Dressing Forceps	102,105
Bates Universal Curettes	48	Drums, Sterilization	123
Beale Wax, Porcelain and Modelling Carvers	70	Dumont Pliers	88
Bein Root Elevators	27		
Bennet Plastic Filling Instruments	38	E	
Beyer Forceps, Bone Rongeur	112	Ehrlicke Stainless Steel Impression Trays	85-86
Black Cutting Instruments	66	Elevators & Raspatories	111
Blumenthal Forceps, Bone Rongeur	112	Elevators, Root	27-32
Bohler Bone Rongeurs	112	Ermet Wax Knife	70
Bohn Crown Instrument	72	Excavators	58-61
Boley Sliding Caliper	129	Explorers	62-63
Bone Curettes	115-117	Extracting Forceps for Children, American Pattern	15
Bow Compasses	129	Extracting Forceps for Children, English Pattern	12-14
Bowls, Kidney	121	Extracting Forceps	2-24
Bowls, Round	120	Extracting Forceps, with Alfa handle	11
Bowmann Lacrimal Probes	113	Extracting Forceps, American Pattern	16-24
Boxes, Instrument	121,122	Extracting Forceps, English Pattern	2-10
Brewer Rubber Dam Instruments	74		
Bruenings Tongue Depressors	113	F	
Bunting Universal Curettes	48	F. Barry Root Elevators	30
Burnishers	42	Farabeuf Retractors, Soft Tissue	109
Byrd Suction Tubes	126	Farrell Cotton Applicators	113
		Fedi Periodontia Instruments	55
C		Fehnenstock, Wax Knife	70
Calipers	129	Files	66
Cartridge Syringes	127	Finger Protectors	129
Cases, Needle Sterilizing	120	Flagg Dental Tweezers	103
Castroviejo Needle Holder	107	Flohr Root Elevators	28
Caulk Dental Tweezers	104	Forceps	102-106
Cement Spatula	43,44	Forceps, Artery	105,106
Cheatle Forceps, Sterilizing	128	Forceps, Bone Cutting	112
Chip Blowers	127	Forceps, Bone Rongeur	112
Chiropody Instruments	128	Forceps, Dissecting, TC	102
Chisels, Bone	115	Forceps, Splinter	106
Chompret Root Elevators	29	Forceps, Sterilizing	128
Citelli Bone Rongeurs	111	Forceps, Tissue and Organ Holding	106
Cleveland Forceps, Bone Cutting	112	Forceps, Tissue	102,106
Cogswell Suction Tubes	126	Forceps, Tongue Holding	118
Coleman Root Elevators	29	Forceps, Towel	105
Collin Forceps, Tongue Holding	118	Frahm Wax, Porcelain & Modelling Carver	68
Collin Mallets	116	Frazier Skin Hook	109
Collin-Hartmann Retractors, Soft Tissue	109	Frazier Suction Tubes	126
Columbia Scalers & Curettes	47	Freer Elevator	111
Containers for Cotton Wool	122	Friedman Forceps, Bone Rongeur	111
Cottle Bone chisels	115	Friedman Root Elevators	26
Cotton Applicators	113	Furrer pliers, Copper Ring and Bridge Removing	90
Cotton Dispenser	122		
Coupland Root Elevators	27		
Coupland Suction Tubes	126		
Crane Pick Root Elevators	28		

	<i>Page</i>		<i>Page</i>
G			
Gauze Packers	113	Lecluse Root Elevators	31
Gillies Needle Holder	107	Locklin Gum Scissors	100,101
Gillies Needle Holders, TC	108	Locklin Gum Scissors, TC	101
Gillies Skin Hooks	109	Lodo Pliers, Copper Ring and Bridge Removing	90
Gingivectomy Knives	51	London College Tweezers, Cotton	103
Gisy-Wild Wax, Porcelain and Modelling Carver	70	Lowrence Read, Extracting Forceps	08
Goldman Fox Periodontia Instruments	53,54	Lucas Bone Curettes	117
Goldman Universal Curettes	48	Luer Forceps, Bone Rongeur	112
Gracey Periodontia Instruments	56	Luks Nerve Instruments	65
Gross-Maier Dressing & Cotton Swab Forceps	105	Luniathek Gauze Packers	113
Gum Knives	98		
Gum Scissors	100	M	
Guthrie Skin Hooks	109	Mallery Universal Curettes	48
Guy Tongue Holding Forceps	118	Mallets	116
		Mathieu Needle Holders	107
H		Mathieu Needle Holders, TC	108
Halsey Needle Holders, TC	108	Matrix Bands	73
Halsted-Mosquito Artery Forceps	105	Matrix Retainers	73,74
Handle for Mouth Mirrors	130	Maunder Wedges, Oral	129
Harris Extracting Forceps, American Pattern	17-18	Mayo Hegar Needle Holders	107
Hartmann Forceps, Artery	105	Mayo Hegar Needle Holders, TC	108
Heidebrink Root Elevators	29	Mayo Tongue Depressors	113
Heidemann Plastic Filling Instruments	39	McCall Periodontia Instruments	52
Heister Mouth Gags	114	McCall Scalars	46
Hemingway Mod Bone Curettes	116	Mclvor Mouth Gags	118
Henahan Extracting Forceps, American Pattern	16	Mckellops Pliers	95
Hirschfeld Files	66	Mead Extracting Forceps	10
Hollenback Amalgam Instruments	37	Mead Mallets	116
Hollenback Wax, Porcelain & Modelling Carvers	68	Measuring Instruments	129
Hooks, Skin	109	Meriam Tweezer, Cotton and Dressing	103
How Pliers	89,94	Mershon Instruments for Crown Work	71
Hull Extracting Forceps, American Pattern	21	Methot Dispensers, Gauze and Cotton	122
Hygenist Periodontia Instruments	52	Metzenbaum Delicate Scissors, Dissecting	99
Hysin Root Elevators	27	Metzenbaum Delicate Scissors, TC	101
Hysin Wax Knife	69	Metzenbaum Scissors, Dissecting	99
		Micrometers	129
I		Micro-Ryder Needle Holder TC	108
Impression Trays	76-86	Miller Paper Clip	71
Indiana University Universal Curettes	48	Miller Root Elevators	28
Instruments for Crown Work	71,72	Miller-Colbrun Bone Curettes	117
Interproximal Wax, Porcelain & Modelling Carvers	68	Mirrors, Mouth	130
Ivory Amalgam Instruments	36	Mod. PHF Bone Curettes	116
Ivory Matrix Retainers	73,74	Mod. Plastic Filling Instruments	38,40
Iwanson Decimal Spring Calipers	129	Mod. USA Amalgam Instruments	37
		Molt Mouth Gag	114
J		Molt Raspatories, Periosteal	111
Jaquette Periodontia Instruments	52	Mouth Gags	114,118
Jaquette Scalars	46		
Jarabak Pliers	93	N	
Jars, Forceps	121	Nabers Pernodontia Instruments	53
Jennings Mouth Gags	114	Napkin Holders	129
Johnson Pliers, Contouring	89	Needle Cases	120
Jones Towel Forceps	105	Needle Holders	107,108
		Needle Holders, TC	108
K		Nerve Instruments	64,65
Kells Extracting Forceps, American Pattern	22	Nevius Extracting Forceps, American Pattern	21,22
Kelly Gum Scissors, TC	101	Nippers, Cuticle	128
Kerrison Bone Rongeurs	111	Nippers, Nail	128
Keyes Dermal Punch	113	Norm Trays	124
Kidney Trays	121	Nuboer Suction Tubes	126
Kilner Skin Hook	109		
Kirkland Gingivectomy Knives	51	O	
Klein Extracting Forceps for Children, with Spring	14	Obwegeser Retractors, Soft Tissue	110
Knives & Scalpels	98	Ochsenbein Periodontia Instruments	55
Konrich Sterilizing Drums	123	Ochsner-Kocher, Hemostatic Forceps	106
Krallengnber Elevators	31	Olsen Hegar Needle Holders	107
Kroenig Tongue Depressors	113	Olsen-Hegar Needle Holders, TC	108
		Oringer Self retaining Cheek Lip Retractors	114
L			
La Grange Gum Scissors	100	P	
Langenbeck Elevators	111	Parmly Extracting Forceps, American Pattern	19
Langenbeck Finger Protectors	129	Partsch Chisels, Bone	115
Langenbeck Retractors	110	Passow Bone Chisels	115
Langer Scalars & Curettes	47	Periodontia Instruments	50-56
Le Cron Wax, Procelain & Modelling Carvers	70	Perry Dental Tweezers	103
		Physick Extracting Forceps, American Pattern	16

	Page		Page
Plastic Filling Instruments	38-41	Suction Tubes	126
Pliers, Bond Bracket	91,92	Surgery Instruments	125-130
Pliers, Contouring	89	Syringes Cartridges	127
Pliers, Copper Ring and Bridge Removing	90	Syringes, Water	127
Pliers, Crown	89		
Pliers, Flat Nose	88	T	
Pliers, Loop Forming & Bending	94,95	Thomas Modelling Carvers	69
Pliers, Orthodontic	88-96	Tobold Tongue Depressors	118
Pliers, Bar Bending	88	Tofflemire Matrix Bands	73
Pliers, Band Seating	91	Tofflemire-Universal Matrix Retainers	73
Pliers, Universal	90	Tomes Extracting Forceps	20
Pliers, Wire Arch and Clasp Bending	89,91-93	Tongue Depressors	113,118
Pliers, Wire Cutting Pliers	96	Towner Jaquette Periodontia Instruments	52
Pott Root Elevators	31	Trays, Half	124
Prichard Periodontia Instruments	53	Trays, Instruments Storing	120
Probes (Explorers)	62-63	Trays, Norm	124
Probes Periodontia	50	Trays, Universal	100
Professional Napkin Holders	129	Treyemann Instruments for Crown Work	71
		Tuft Wax, Procelain and Modelling Carvers	68
Q		Turnbull Nipper, Nail	128
Quinby Gum Scissors	100	Tweed Bending & Forming Pliers	93,95
		Tweezers, Cotton & Dressing	103,104
R		U	
Ragnell (Kilner) Gum Scissors, TC	101	Universal Curettes	47,48
Ralk Forceps, Splinter	106	Universal Pliers	90
Raspatories, Periosteal	111	Universal Wire and Crown Scissors	100,101
Retractors	109-110	USA-Mod Dental Tweezers	104
Retractors, Cheek and Lip	113		
Retractors, Soft Tissue	110	V	
Reynolds Pliers	89,93	Vestibulum-Haken	114
Rochester-Pean Hemostatic Forceps	106	Volkman Bone Curettes	115
Root Elevators	26-32	Volkman Retractors	110
Roser Konig Mouth Gag	114		
Roux Retractors	109	W	
Rubber Dam Instruments	74	Wagner Gum Scissors	100
Rule Universal Curettes	48	Waldsachs-Universal Pliers	90
		Walter F. Barry Root Elevators	28,30,32
S		Ward Wax, Porcelain and Modelling Carver	68
Sachs Instruments for Crown Work	71	Ward-Kirkland Periodontia instruments	51
Sand Glass	129	Warwick James Root Elevators	32
Scalers	46-48	Wax, Porcelain and Modelling Carvers	68-70
Scalpel Handles	98	Wedges, Oral	129
Scalpel Blades	98	Weingart Pliers	94
Schimmelbusch Sterilizing Drums	123	West Root Elevators	32
Schroeder Instruments for Crown Work	71	White Burnishers	42
Schwarz Pliers, Bar Bending	88	White Excavators	59
Scissors	99-101	White Plastic Filling Instruments	39
Scissors, Cuticle	128	Wieder Tongue Depressors	118
Scissors, Dissecting	99,101	Wiland Wax, Porcelain and Modelling Carvers	68
Scissors, Gum	99,100	Williams Plastic Filling Instruments	38
Scissors, Gum, TC	101	Williger Bone Curettes	115
Scissors, Nail	128	Williger Elevators	111
Scissors, Operating Fine	99	Winter Root Elevators	30
Scissors, Operating	99	Woodson Plastic Filling Instruments	39
Scissors, TC	99,101	Woodward Extracting Forceps	17
Scissors, Wire and Crown	100,101		
Seldin Root Elevators	28	Y	
Semken Tissue Forceps	102	Yankauer Suction Tubes	126
Senn-Miller Retractors	109	Yonger Good Universal Curettes	48
Sets, Dental Instruments	132,133	Young Pliers, Wire, Arch and Clasp Bending	89
Sliding Caliper	129		
Spatulas	128	Z	
Spatulas, Cement	43,44,128	Zahle Wax Knife	69
Spirit Lamp	122		
Spring Calipers	129		
Stadler Pliers	89		
Standard Extracting Forceps, American Pattern	16-24		
Standard Forceps, Dressing	102		
Standard Scalpel Handles	98		
Standard Scissors, Operating	99		
Sterilization	119-124		
Sterilizing Drums	123		
Sternberg Retractors, Cheek and Lip	113		
Stieglitz Splinter Forceps	106		
Stockes Rubber Dam Instruments	74		



Address: Daska Road Bograh Green Town 51310 Sialkot Pakistan.

Mobile / WhatsApp: +92 313 2727333 , +92 052 3259425

Email₁: sales@denticon.com.pk

Email₂: info@denticon.com.pk

Website: www.denticon.com.pk